

Ultrafast Rectifier

Features

- Two Common-Cathode Diodes
- Ultrafast Reverse Recovery
- Ultrasoft Reverse Recovery Current Shape
- Low Forward Voltage Drop
- Low Leakage Current
- Optimized for Power Conversion: Welding and Industrial SMPS Applications
- Up to 175°C Operating Junction Temperature

$$t_{rr} = 28\text{ns}$$

$$I_{F(AV)} = 70\text{A}$$

$$@T_C = 145^\circ\text{C}$$

$$V_R = 200\text{V}$$

Description/ Applications

The 70CRU02 integrates two state-of-the-art International Rectifier's Ultrafast recovery rectifiers in the common-cathode configuration. The planar structure of the diodes, and the platinum doping life-time control, provide a Ultrasoft recovery current shape, together with the best overall performance, ruggedness and reliability characteristics.

These devices are thus intended for high frequency applications in which the switching energy is designed not to be predominant portion of the total energy, such as in the output rectification stage of Welding machines, SMPS, DC-DC converters. Their extremely optimized stored charge and low recovery current reduce both over-dissipation in the switching elements (and snubbers) and EMI/RFI.

Absolute Maximum Ratings

Parameters	Max	Units
V_R Cathode to Anode Voltage	200	V
$I_{F(AV)}$ Continuous Forward Current $T_C = 145^\circ\text{C}$ Per Diode	35	A
I_{FSM} Single Pulse Forward Current $T_C = 25^\circ\text{C}$ Per Diode	300	
P_D Maximum Power Dissipation $T_C = 100^\circ\text{C}$ Per Module	67	W
T_J, T_{STG} Operating Junction and Storage Temperatures	- 55 to 175	$^\circ\text{C}$

Case Styles

70CRU02



TO-218

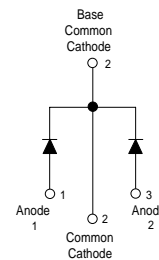

Electrical Characteristics per Diode @ T_J = 25°C (unless otherwise specified)

Parameters	Min	Typ	Max	Units	Test Conditions
V _{BR} , V _r Breakdown Voltage, Blocking Voltage	200	-	-	V	I _R = 60μA
V _F Forward Voltage	-	0.95	1.09	V	I _F = 35A
	-	0.9	1.0	V	I _F = 35A, T _J = 125°C
	-	0.85	0.9	V	I _F = 35A, T _J = 175°C
I _R Reverse Leakage Current	-	-	60	μA	V _R = V _R Rated
	-	-	2	mA	T _J = 150°C, V _R = V _R Rated
C _T Junction Capacitance	-	50	-	pF	V _R = 200V
L _S Series Inductance	-	10	-	nH	Measured from A-lead to K-lead 5mm from package body

Dynamic Recovery Characteristics per Diode @ T_J = 25°C (unless otherwise specified)

Parameters	Min	Typ	Max	Units	Test Conditions
t _{rr} Reverse Recovery Time	-	-	28	ns	T _J = 25°C
	-	34	-		T _J = 125°C
	-	26	-		T _J = 25°C
	-	49	-		T _J = 125°C
I _{RRM} Peak Recovery Current	-	3.7	-	A	T _J = 25°C
	-	8.2	-		T _J = 125°C
Q _{rr} Reverse Recovery Charge	-	48.7	-	nC	T _J = 25°C
	-	202	-		T _J = 125°C

I_F = 1A
V_R = 30V
di_F/dt = 200A/μs

I_F = 35A
V_{RR} = 100V
di/dt = 200A/μs

Thermal - Mechanical Characteristics

Parameters	Min	Typ	Max	Units
R _{thJC} Thermal Resistance, Junction to Case Per Diode	-	0.8	0.9	K/W
R _{thJC} Thermal Resistance, Junction to Case Both Leg	-	-	0.45	
R _{thCS} ⁽¹⁾ Thermal Resistance, Case to Heatsink	-	0.2	-	
Wt Weight	-	5.5	-	g
	-	0.2	-	(oz)
T Mounting Torque	1.2	-	2.4	N * m
	10	-	20	lbf.in

(1) Mounting Surface, Flat, Smooth and Greased

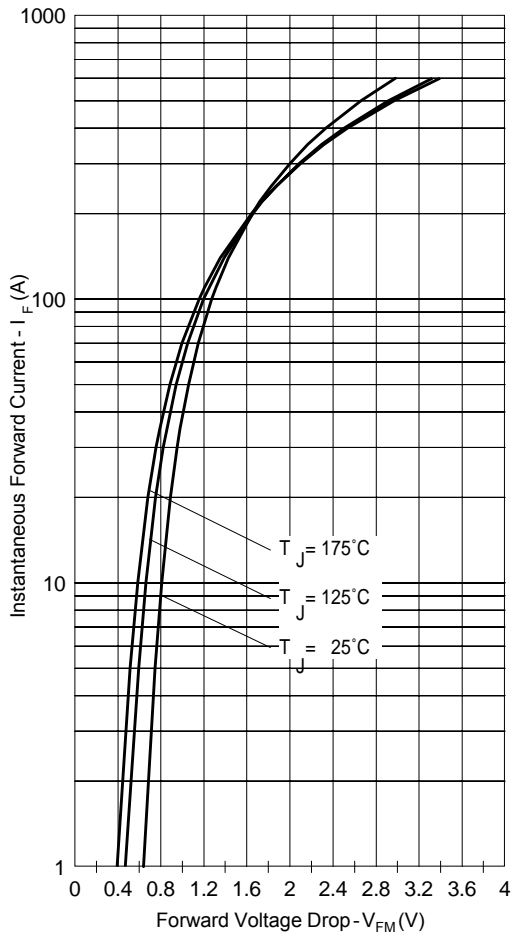

Fig. 1 - Typical Forward Voltage Drop Characteristics (Per Diode)

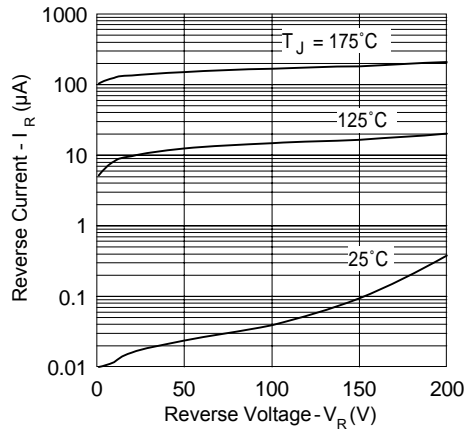

Fig. 2 - Typical Values Of Reverse Current Vs. Reverse Voltage

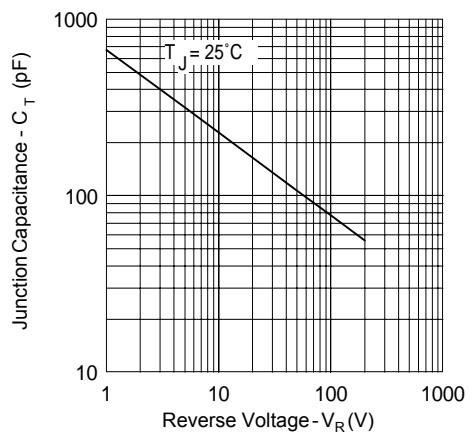

Fig. 3 - Typical Junction Capacitance Vs. Reverse Voltage

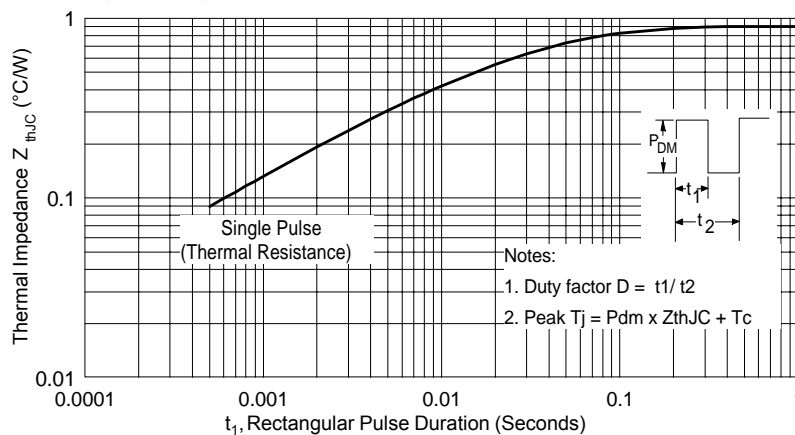

Fig. 4 - Max. Thermal Impedance Z_{thJC} Characteristics (Per Diode)

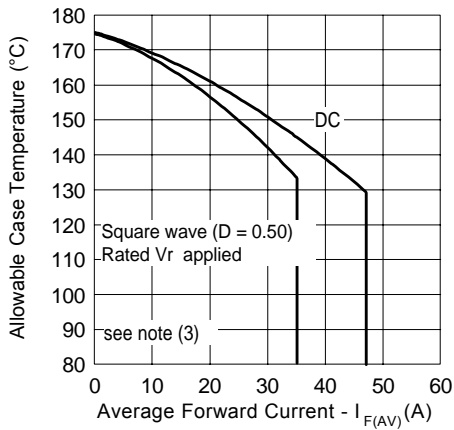

Fig. 5 - Max. Allowable Case Temperature Vs. Average Forward Current

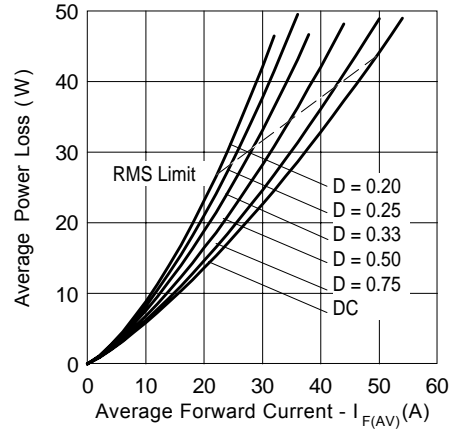

Fig. 6 - Forward Power Loss Characteristics

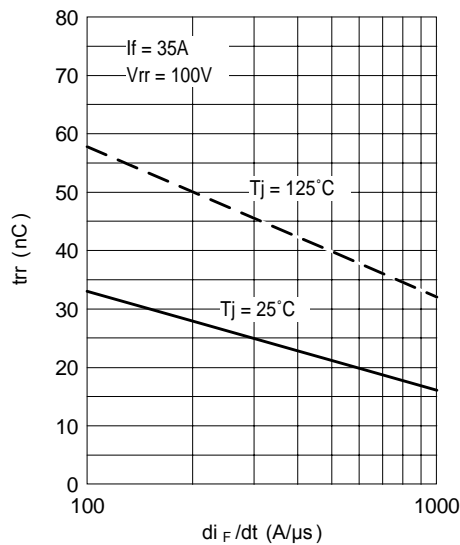

Fig. 7 - Typical Reverse Recovery vs. di_F/dt

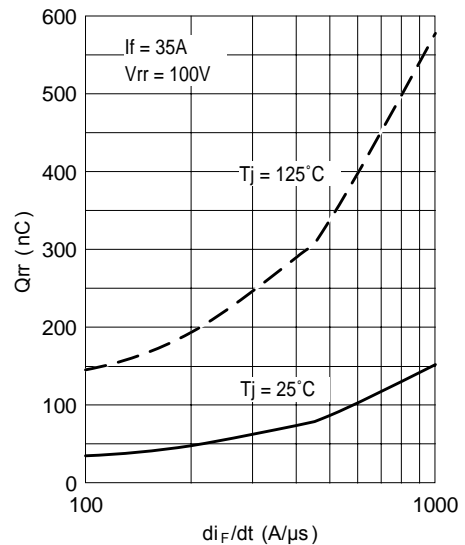

Fig. 8 - Typical Stored Charge vs. di_F/dt

(3) Formula used: $T_c = T_j - (P_d + P_{d_{REV}}) \times R_{thJC}$;
 $P_d = \text{Forward Power Loss} = I_{F(AV)} \times V_{FM} @ (I_{F(AV)} / D)$ (see Fig. 6);
 $P_{d_{REV}} = \text{Inverse Power Loss} = V_{R1} \times I_R (1 - D)$; $I_R @ V_{R1} = \text{rated } V_R$

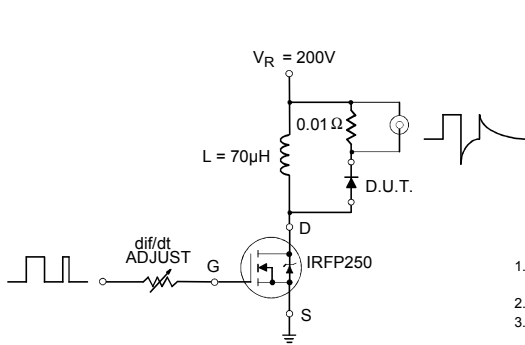
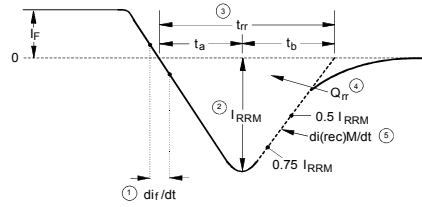

Fig. 9 - Reverse Recovery Parameter Test Circuit



1. di_{rr}/dt - Rate of change of current through zero crossing
2. I_{RRM} - Peak reverse recovery current
3. t_{rr} - Reverse recovery time measured from zero crossing point of negative going I_r to point where a line passing through $0.75 I_{RRM}$ and $0.50 I_{RRM}$ extrapolated to zero current
4. Q_{rr} - Area under curve defined by t_{rr} and I_{RRM}
 $Q_{rr} = \frac{t_{rr} \times I_{RRM}}{2}$
5. $di_{(rec)}/dt$ - Peak rate of change of current during t_p portion of t_{rr}

Fig. 10 - Reverse Recovery Waveform and Definitions

Outline Table

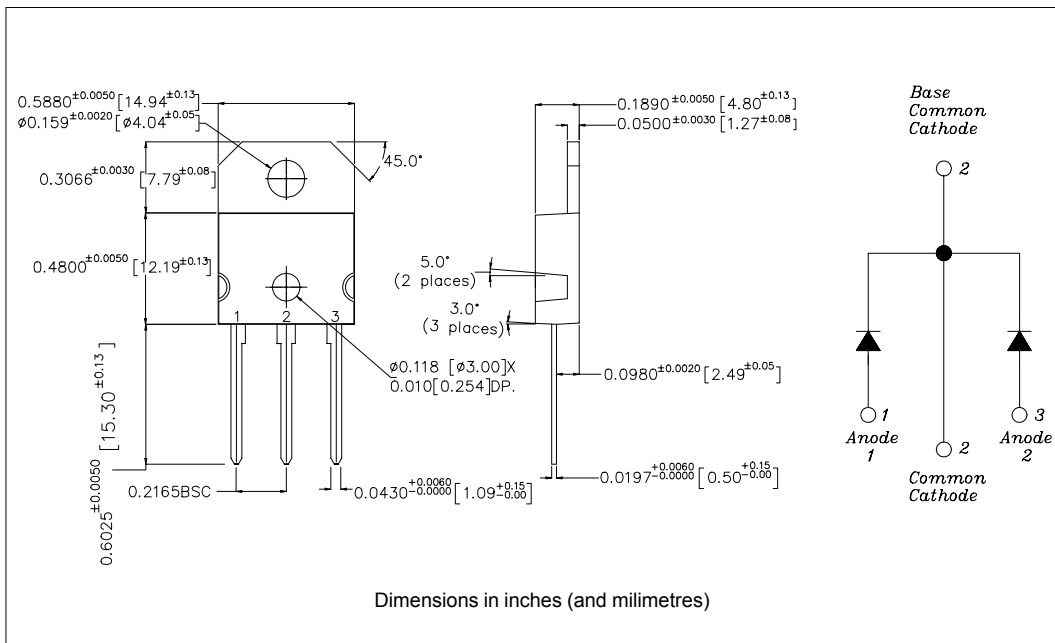

Marking Information

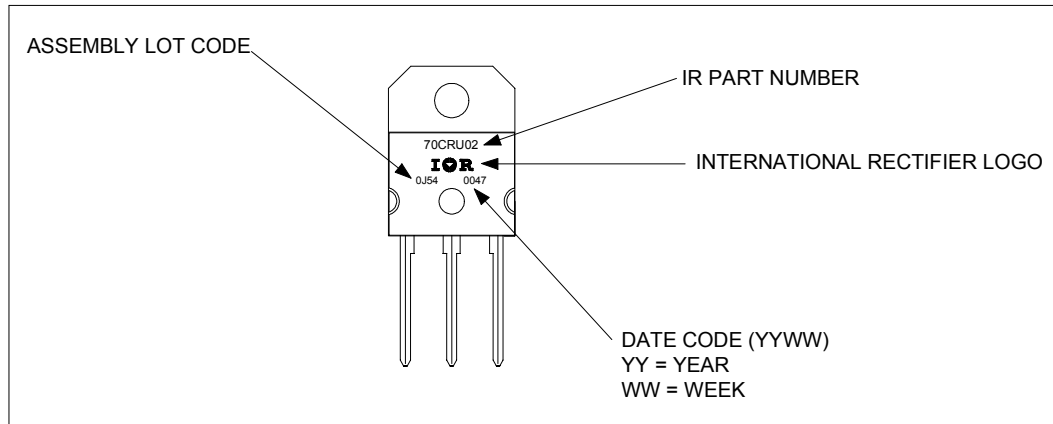

Ordering Information Table

Device Code	
70	C
R	U
02	
①	②
③	④
⑤	

1	-	Current Rating	(70 = 70A)
2	-	Common Cathode	
3	-	TO-218	
4	-	Ultrafast Recovery	
5	-	Voltage Rating	(02 = 200V)

Data and specifications subject to change without notice.
This product has been designed and qualified for Industrial Level.
Qualification Standards can be found on IR's Web site.