

2SK3042

Silicon N-Channel Power F-MOS FET

■ Features

- Avalanche energy capacity guaranteed: $EAS > 45\text{mJ}$
- High-speed switching: $t_f = 30\text{ns}$
- No secondary breakdown

■ Applications

- Contactless relay
- Diving circuit for a solenoid
- Driving circuit for a motor
- Control equipment
- Switching power supply

■ Absolute Maximum Ratings ($T_C = 25^\circ\text{C}$)

Parameter	Symbol	Rated	Unit
Drain to Source breakdown voltage	V_{DSS}	250	V
Gate to Source voltage	V_{GSS}	± 20	V
Drain current	DC	I_D	± 7 A
	Pulse	I_{DP}	± 14 A
Avalanche energy capacity	EAS*	45	mJ
Allowable power dissipation	$T_C = 25^\circ\text{C}$	P_D	35 W
	$T_a = 25^\circ\text{C}$		2
Channel temperature	T_{ch}	150	$^\circ\text{C}$
Storage temperature	T_{stg}	-55 to +150	$^\circ\text{C}$

* $L = 0.1\text{mH}$, $I_L = 8\text{A}$, $V_{DD} = 50\text{V}$, 1 pulse

■ Electrical Characteristics ($T_C = 25^\circ\text{C}$)

Parameter	Symbol	Conditions	min	typ	max	Unit
Drain to Source cut-off current	I_{DSS}	$V_{DS} = 200\text{V}$, $V_{GS} = 0$			0.1	mA
Gate to Source leakage current	I_{GSS}	$V_{GS} = \pm 20\text{V}$, $V_{DS} = 0$			± 1	μA
Drain to Source breakdown voltage	V_{DSS}	$I_D = 1\text{mA}$, $V_{GS} = 0$	250			V
Gate threshold voltage	V_{th}	$V_{DS} = 10\text{V}$, $I_D = 1\text{mA}$	1		5	V
Drain to Source ON-resistance	$R_{DS(on)}$	$V_{GS} = 10\text{V}$, $I_D = 5\text{A}$		0.4	0.6	Ω
Forward transfer admittance	$ Y_{fs} $	$V_{DS} = 10\text{V}$, $I_D = 5\text{A}$	2.7	4.7		S
Diode forward voltage	V_{DSF}	$I_{DR} = 8\text{A}$, $V_{GS} = 0$			-1.7	V
Input capacitance (Common Source)	C_{iss}	$V_{DS} = 10\text{V}$, $V_{GS} = 0$, $f = 1\text{MHz}$		1100		pF
Output capacitance (Common Source)	C_{oss}			200		pF
Reverse transfer capacitance (Common Source)	C_{rss}			60		pF
Turn-on time (delay time)	$t_{d(on)}$	$V_{GS} = 10\text{V}$, $I_D = 5\text{A}$		20		ns
Rise time	t_r			20		ns
Turn-off time (delay time)	$t_{d(off)}$	$V_{DD} = 100\text{V}$, $R_L = 20\Omega$		130		ns
Fall time	t_f			30		ns

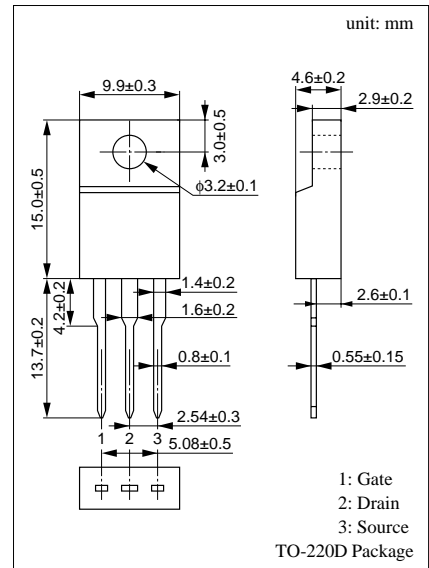

Area of safe operation (ASO)

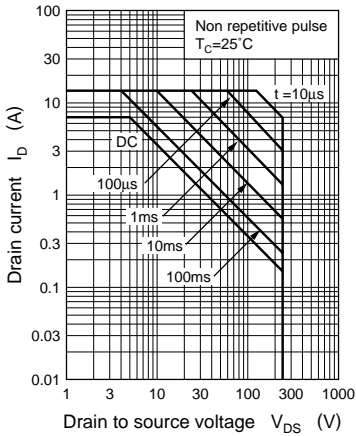

$P_D - T_a$

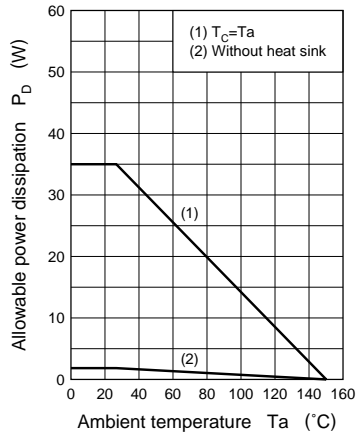

$I_D - V_{DS}$

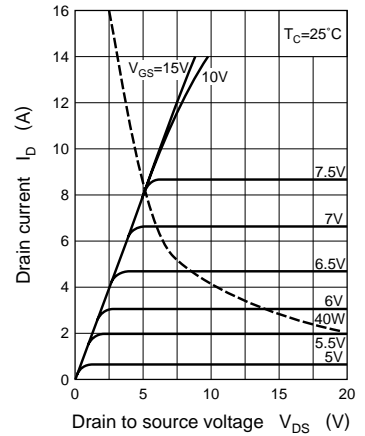

$I_D - V_{GS}$

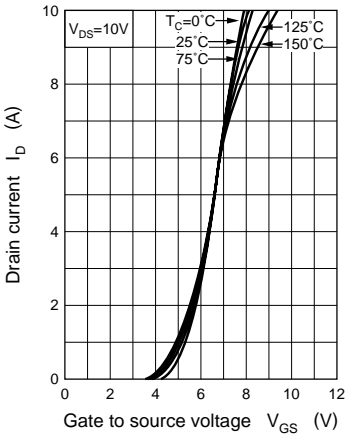

$V_{GS} - T_C$

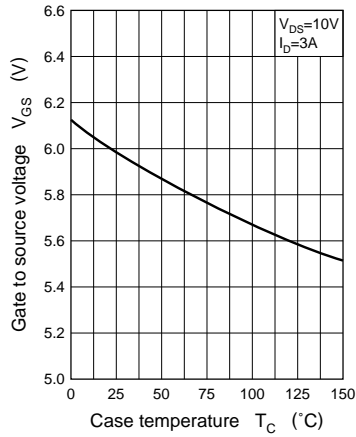

$V_{th} - T_C$

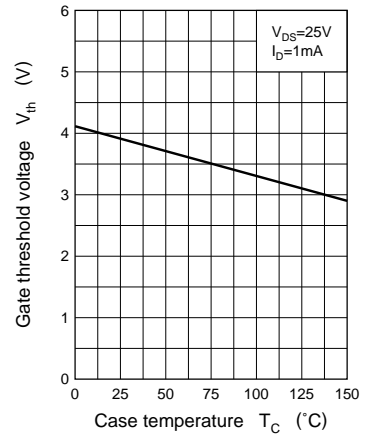

$R_{DS(on)} - I_D$

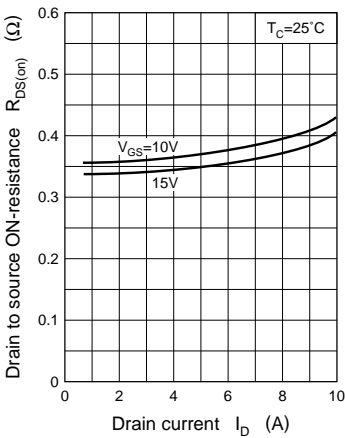

$|Y_{fs}| - I_D$

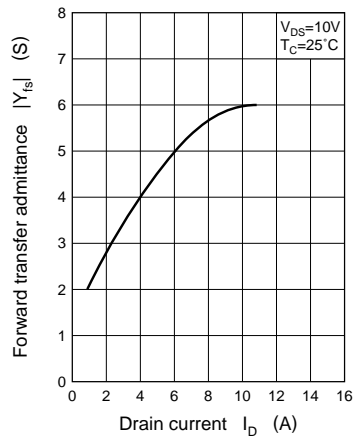

$C_{iss}, C_{oss}, C_{rss} - V_{DS}$

