



2SC4774

NPN SILICON TRANSISTOR

HIGH FREQUENCY AMPLIFIER
TRANSISTOR, RF SWITCHING
(6V, 50mA)

■ FEATURES

- * Very low output-on resistance (R_{ON}).
- * Low capacitance.

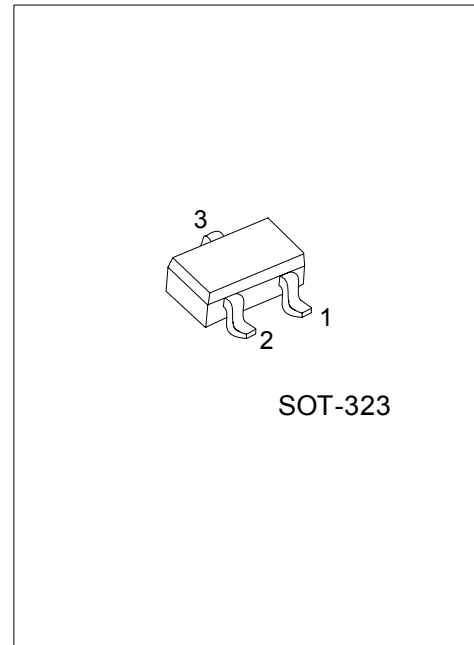

*Pb-free plating product number: 2SC4774L

■ ORDERING INFORMATION

Order Number		Package	Pin Assignment			Packing
Normal	Lead Free Plating		1	2	3	
2SC4774-AL3-R	2SC4774L-AL3-R	SOT-323	E	B	C	Tape Reel

<p>2SC4774L-AL3-R</p> <p>(1)Packing Type (2)Package Type (3)Lead Plating</p>	<p>(1) R: Tape Reel (2) AL3: SOT-323 (3) L: Lead Free Plating, Blank: Pb/Sn</p>
--	---

■ MARKING

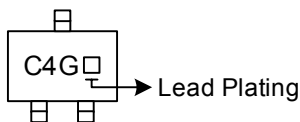

■ ABSOLUTE MAXIMUM RATINGS (Ta=25°C)

PARAMETER	SYMBOL	RATINGS	UNIT
Collector-Base Voltage	V_{CBO}	12	V
Collector-Emitter Voltage	V_{CEO}	6	V
Emitter-Base Voltage	V_{EBO}	3	V
Collector Current	I_C	50	mA
Collector Power Dissipation	P_D	0.2	W
Junction Temperature	T_J	+150	°C
Storage Temperature	T_{STG}	-40 ~ +150	°C

Note Absolute maximum ratings are those values beyond which the device could be permanently damaged.

Absolute maximum ratings are stress ratings only and functional device operation is not implied.

■ ELECTRICAL SPECIFICATIONS (Ta=25°C)

PARAMETER	SYMBOL	TEST CONDITIONS	MIN	TYP	MAX	UNIT
Collector-Base Breakdown Voltage	BV_{CBO}	$I_C = 10\mu A$	12			V
Collector-Emitter Breakdown Voltage	BV_{CEO}	$I_C = 1mA$	6			V
Emitter-Base Breakdown Voltage	BV_{EBO}	$I_E = 10\mu A$	3			V
Collector Cutoff Current	I_{CBO}	$V_{CB} = 10V$			0.5	V
Emitter Cutoff Current	I_{EBO}	$V_{EB} = 2V$			0.5	μA
Collector-Emitter Saturation Voltage	$V_{CE(SAT)}$	$I_C/I_B = 10mA/1mA$			0.3	μA
DC Current Transfer Ratio	h_{FE}	$V_{CE}/I_C = 5V/5mA$	270		560	
Transition Frequency	f_T	$V_{CE} = 5V, I_E = -10mA, f = 200MHz$	300	800		MHz
Output Capacitance	C_{ob}	$V_{CB} = 10V, I_E = 0A, f = 1MHz$		1	1.7	pF
Output-On Resistance	R_{ON}	$I_B = 3mA, V_{IN} = 100mV_{rms}, f = 500kHz$		2		Ω

TYPICAL CHARACTERISTIC

Grounded Emitter Output Characteristics ()

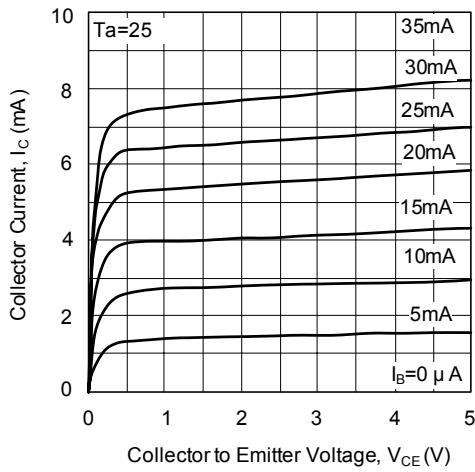

Grounded Emitter Output Characteristics ()

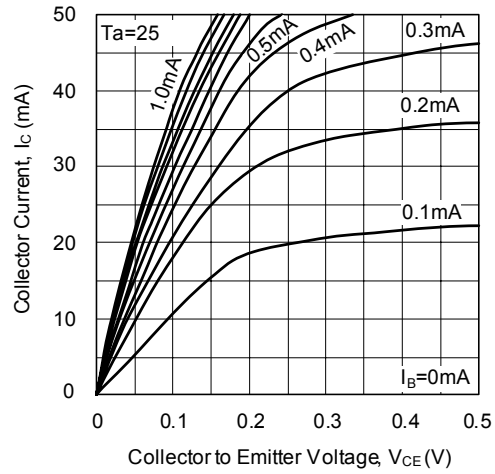

Grounded Emitter Propagation Characteristics

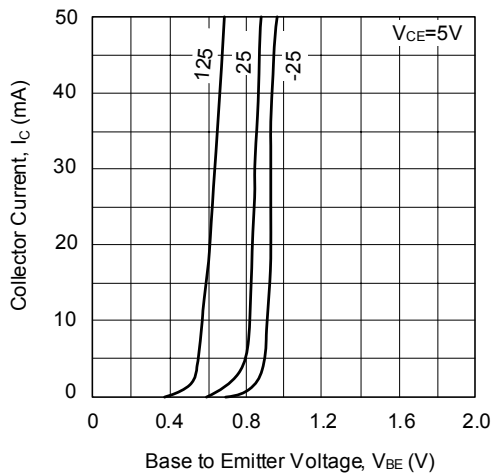

DC Current Gain vs. Collector Current

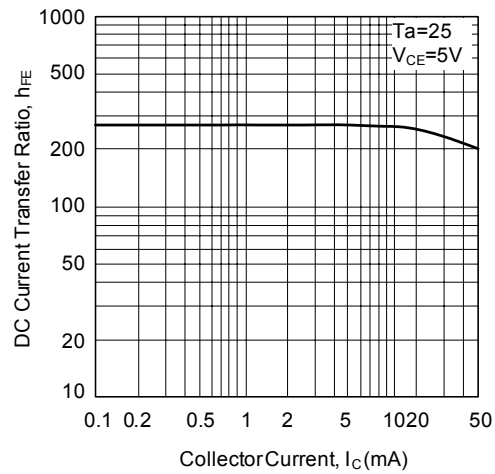

Collector-Emitter Saturation Voltage vs. Collector Current

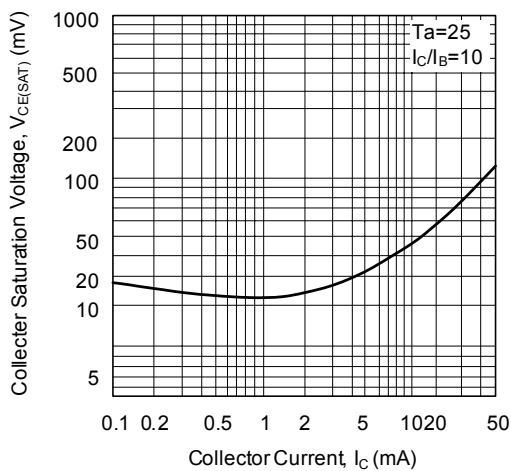

Gain Bandwidth Product vs. Collector Current

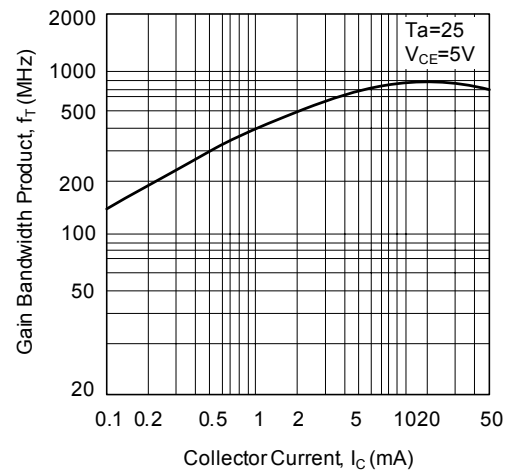

■ TYPICAL CHARACTERISTIC(Cont.)

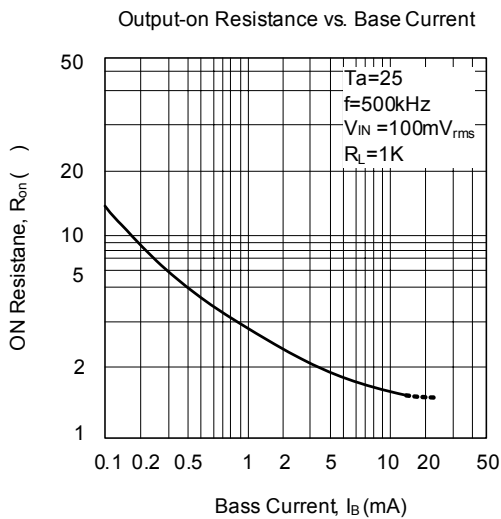
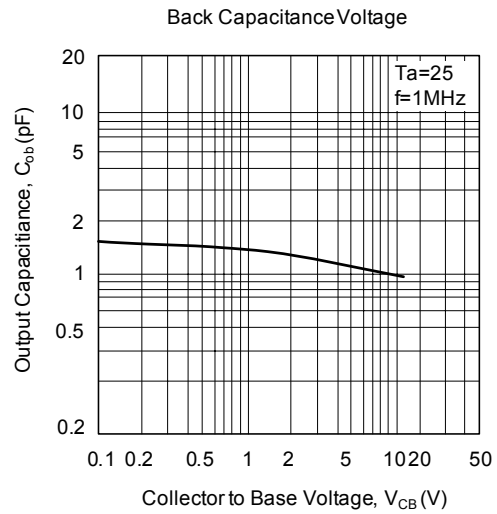
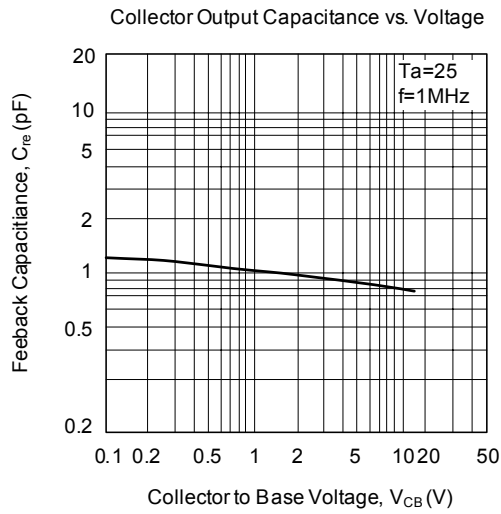

UTC assumes no responsibility for equipment failures that result from using products at values that exceed, even momentarily, rated values (such as maximum ratings, operating condition ranges, or other parameters) listed in products specifications of any and all UTC products described or contained herein. UTC products are not designed for use in life support appliances, devices or systems where malfunction of these products can be reasonably expected to result in personal injury. Reproduction in whole or in part is prohibited without the prior written consent of the copyright owner. The information presented in this document does not form part of any quotation or contract, is believed to be accurate and reliable and may be changed without notice.