

GaAs SP6T 2.5 V High Power Switch Dual / Tri / Quad-Band GSM Applications

**MASWSS0091
V6**

Features

- Supplied as Known Good Die
- Dual/tri/quad-band GSM/GPRS/EDGE
- Low Voltage: 2.5V Operation
- Low Harmonics: -72 dBc at +35 dBm & 1 GHz
- Low Insertion Loss: 0.5 dB at 1 GHz
- High Tx-Rx Isolation: 38 dB at 2 GHz

Description

M/A-COM's MASWSS0091 is a GaAs PHEMT MMIC single pole six throw (SP6T) high power switch die. The MASWSS0091 is ideally suited for applications where high power, low control voltage, low insertion loss, high isolation, small size and low cost are required. The MASWSS0091 is designed for dual-, tri-, and quad-band GSM and DCS/PCS handset systems that connect separate transmit and receive functions to a common antenna, and can be used in all systems operating up to 2.5 GHz requiring high power at low control voltage.

The MASWSS0091 is fabricated using a 0.5 micron gate length GaAs PHEMT process. The process features full passivation for performance and reliability.

Ordering Information

Part Number	Package
MASWSS0091SMB	Sample Test Board
MASWSS0091-DIE	Separated die on Grip Ring

Note: Die quantity varies.

Absolute Maximum Ratings ¹

Parameter	Absolute Maximum
Input Power (0.5 - 2.5 GHz, 2.5V Control)	+38 dBm
Voltage	±8.5 volts
Operating Temperature	-40°C to +85°C
Storage Temperature	-65°C to +150°C

1. Exceeding any one or combination of these limits may cause permanent damage to the device.

Die Layout

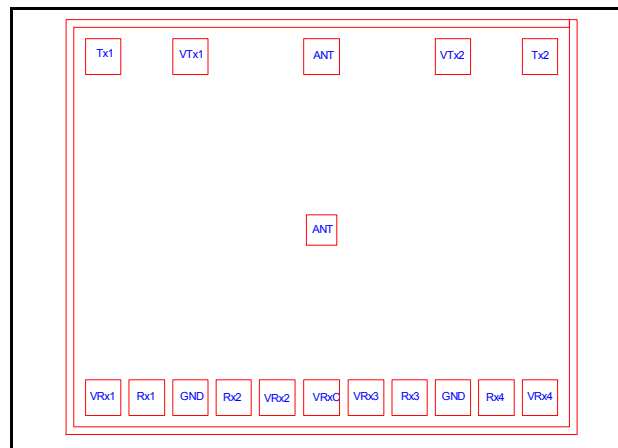

Pad Layout

PAD Name	Description
Tx1	Tx1 Port
VTx1	Tx1 Control
ANT	Antenna Port
VTx2	Tx2 Control
Tx2	Tx2 Port
VRx4	Rx4 Control
Rx4	Rx4 Port
GND	Ground
Rx3	Rx3 Port
VRx3	Rx3 Control
VRxC	Rx Common Control
VRx2	Rx2 Control
Rx2	Rx2 Port
GND	Ground
Rx1	Rx1 Port
VRx1	Rx1 Control
ANT	Redundant ANT Pad

**GaAs SP6T 2.5 V High Power Switch
Dual / Tri / Quad-Band GSM Applications**

**MASWSS0091
V6**

Electrical Specifications: $T_A = 25^\circ\text{C}$, $V_c = 0\text{V}/2.5\text{V}$, $Z_0 = 50\ \text{Ohms}^2$

Parameter	Test Conditions	Units	Min.	Typ.	Max.
Tx Insertion Loss ³	0.5 - 1 GHz	dB	—	0.5	0.7
	1 - 2 GHz	dB	—	0.65	0.9
Rx Insertion Loss ³	0.5 - 1 GHz	dB	—	1.0	1.2
	1 - 2 GHz	dB	—	1.3	1.6
Tx to Rx Isolation	0.5 - 1 GHz	dB	40	45	—
	1 - 2 GHz	dB	—	38	—
Tx to Tx Isolation	0.5 - 1 GHz	dB	22	26	—
	1 - 2 GHz	dB	—	17	—
Return Loss	0.5 - 2.5 GHz	dB	—	20	—
Tx P0.1dB	1 GHz	dBm	—	41	—
Rx P1dB	1 GHz	dBm	—	25	—
2nd Harmonic	1 GHz, $P_{IN} = +35\ \text{dBm}$, 100% Duty Cycle	dBc	—	-78	-67
3rd Harmonic	1 GHz, $P_{IN} = +35\ \text{dBm}$, 100% Duty Cycle	dBc	—	-72	-67
Trise, Tfall	10% to 90% RF, 90% to 10% RF	μS	—	0.2	—
Ton, Toff	50% control to 90% RF, and 50% control to 10% RF	μS	—	0.2	—
Transients	In Band	mV	—	70	—
Control Current	—	μA	—	20	80

2. External DC blocking capacitors are required on all RF ports.

3. Insertion loss can be optimized by varying the DC blocking capacitor value, e.g. 100 pF for 0.5 GHz - 2.0 GHz.

Functional Schematic

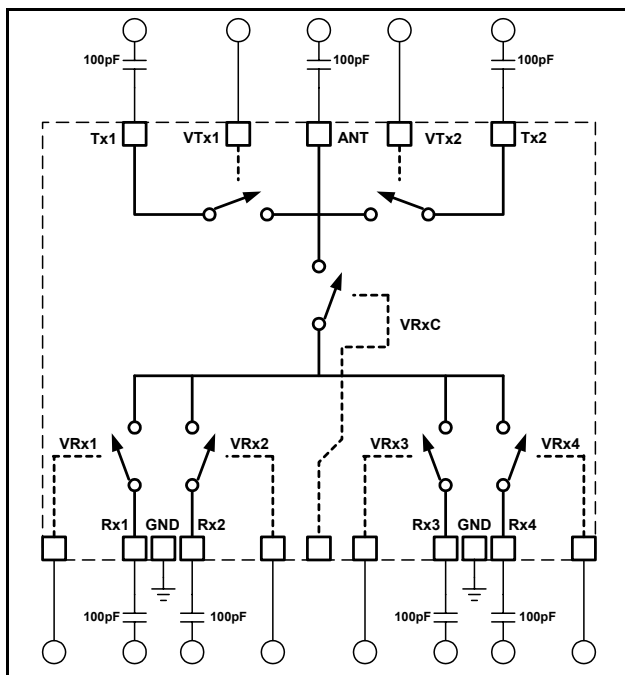

Qualification

Qualified to M/A-COM specification REL-201, Process Flow -2.

Handling Procedures

Please observe the following precautions to avoid damage:

Static Sensitivity

Gallium Arsenide Integrated Circuits are sensitive to electrostatic discharge (ESD) and can be damaged by static electricity. Proper ESD control techniques should be used when handling these devices.

Typical Performance Curves

TX Insertion Loss

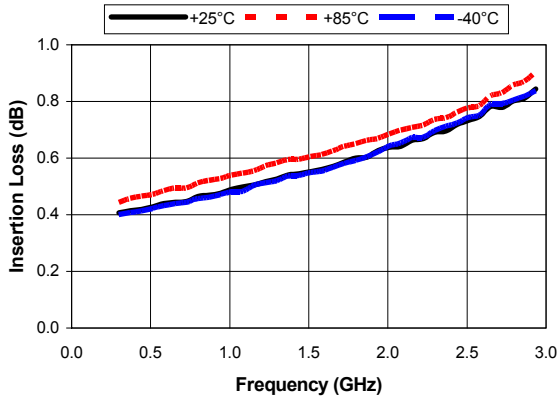

RX Insertion Loss

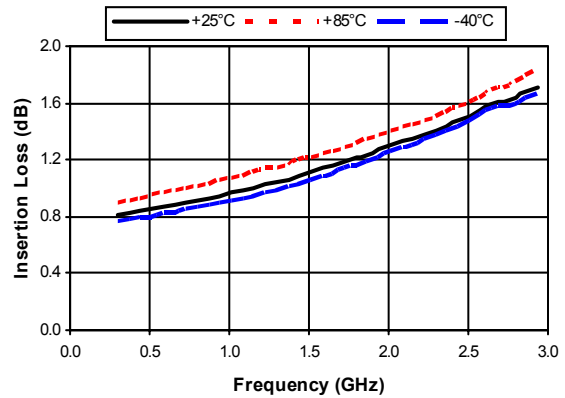

TX - RX Isolation

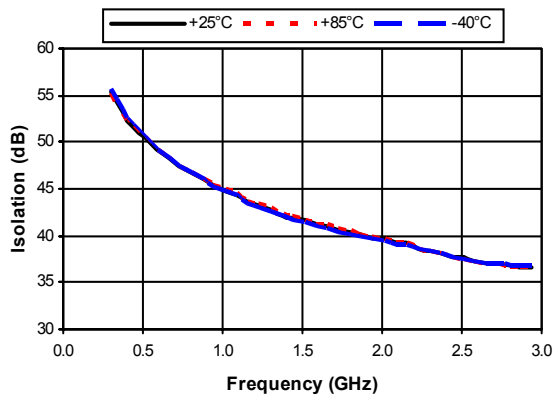

2nd Harmonic vs. Vctrl @ 1 GHz, Pin = +35 dBm, 100% Duty Cycle

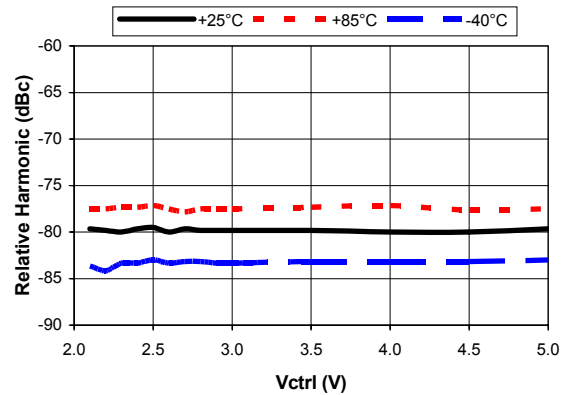

3rd Harmonic vs. Vctrl @ 1 GHz, Pin = +35 dBm, 100% Duty Cycle

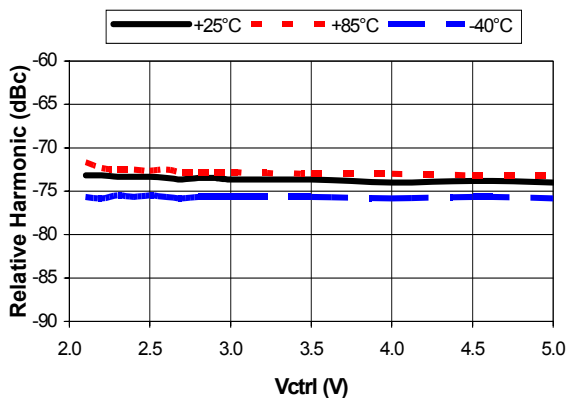

**GaAs SP6T 2.5 V High Power Switch
Dual / Tri / Quad-Band GSM Applications**

**MASWSS0091
V6**

Truth Table ^{4,5}

VTx1	VTx2	VRxC	VRx1	VRx2	VRx3	VRx4	ANT-Tx1	ANT-Tx2	ANT-Rx1	ANT-Rx2	ANT-Rx3	ANT-Rx4
1	0	0	0	0	0	0	On	Off	Off	Off	Off	Off
0	1	0	0	0	0	0	Off	On	Off	Off	Off	Off
0	0	1	1	0	0	0	Off	Off	On	Off	Off	Off
0	0	1	0	1	0	0	Off	Off	Off	On	Off	Off
0	0	1	0	0	1	0	Off	Off	Off	Off	On	Off
0	0	1	0	0	0	1	Off	Off	Off	Off	Off	On

4. Differential voltage, V (state 1) - V (state 0), must be 2.5 V minimum.

5. State 0 = 0 V to +0.2 V, State 1 = 2.5 V to 5 V.