

The RT0301/RT0302 is a CMOS Design for Door Bell application

Features

- Low Operator Voltage 3V ~ 4.5V
- Auto Power down function
- CMOS process
- On-Chip RC oscillator
- Low stand by current at 1 uA
- 8-Pin DIP or chip form available

Pin Diagram

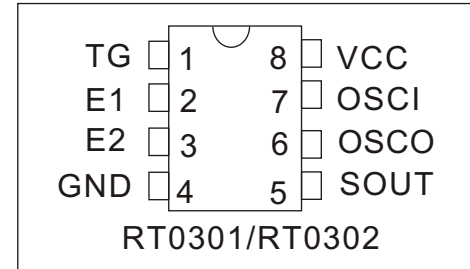

Pin Description

Symbol	Pin Description	Pin	I / O
TG	Trigger Single Input	1	I
E1	"Ding" Freq	2	O
E2	"Dong" Freq	3	I
GND	Ground	4	O
SOUT	Sound output	5	O
OSCO	Frequency put	6	O
OSCI	Frequency In	7	I
Vcc	Power Source Input	8	I

Electrical Characteristics

Vcc = 3V , Temp. = 25°C

Characteristics	Symbol	Min.	Typ.	Max.	Unit	Remarks
Operating Voltage	Vcc	-	3	4.5	V	
Operating Current	Iop	-	0.1	0.5	mA	No Load
Quiescent Current	I _{sb}	-	1	5	uA	
SOUT Driving Current	I _{oc}	1	-	-	mA	@V _{Ds} = 1V
Oscillator Freq	F _{op}	-	50	-	KHz	External ±30%, R _{osc} = 430K
Operating Temp	Temp	0	25	70	°C	

P/N	TIMES
RT0301	1
RT0302	2

**** Function Description:**

When TG PIN's signal changed from low to high, the RT0301/RT0302 will present Ding-Dong sound from Sout PIN. The waveform will be listed below :

● RT0301:

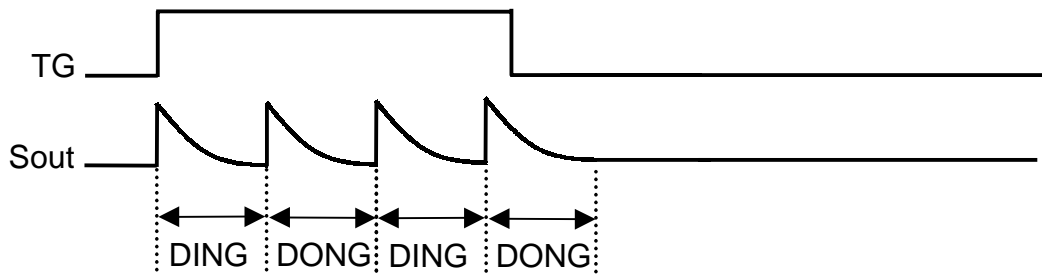
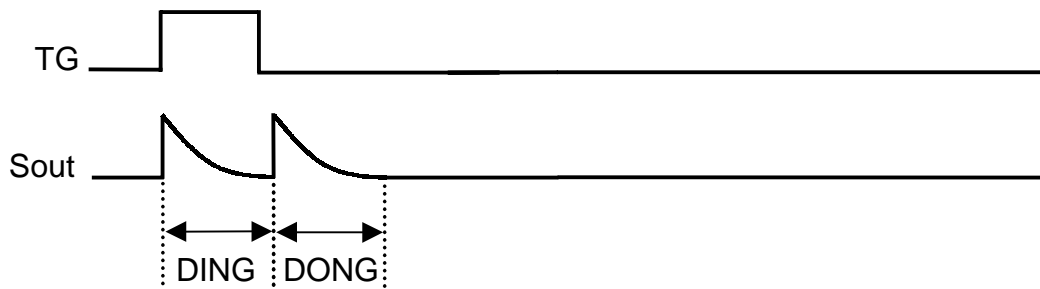

● RT0302:

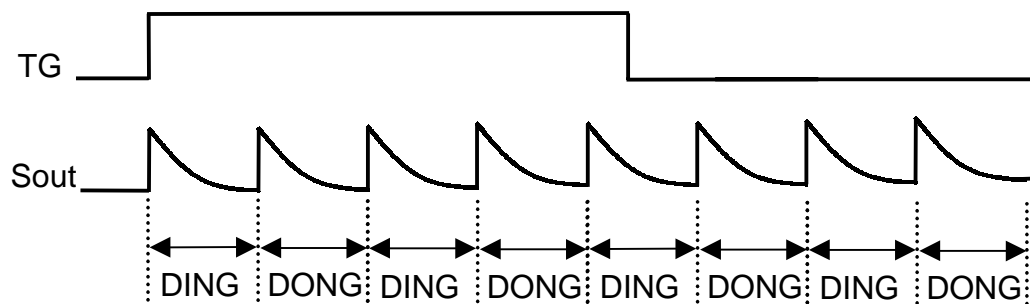
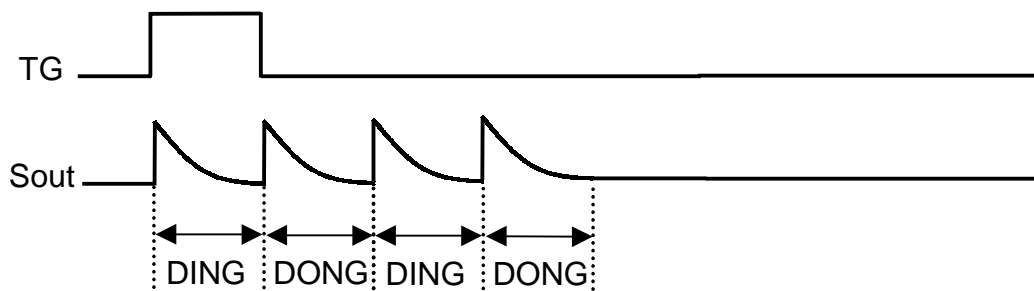

**** Envelope waveform:**

The envelope waveform of DING is controlled by E1's R.C. circuit.

The envelope waveform of DING is controlled by E2's R.C. circuit.

DING:

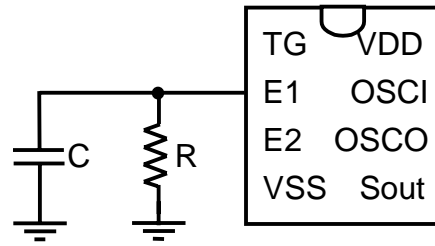

DONG:

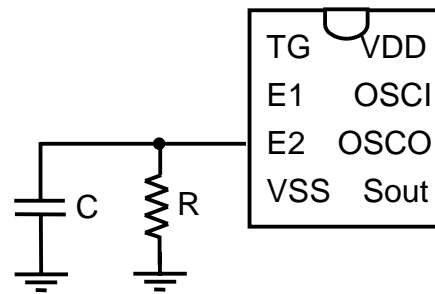

8L P-DIP (300 mil) Dimension:

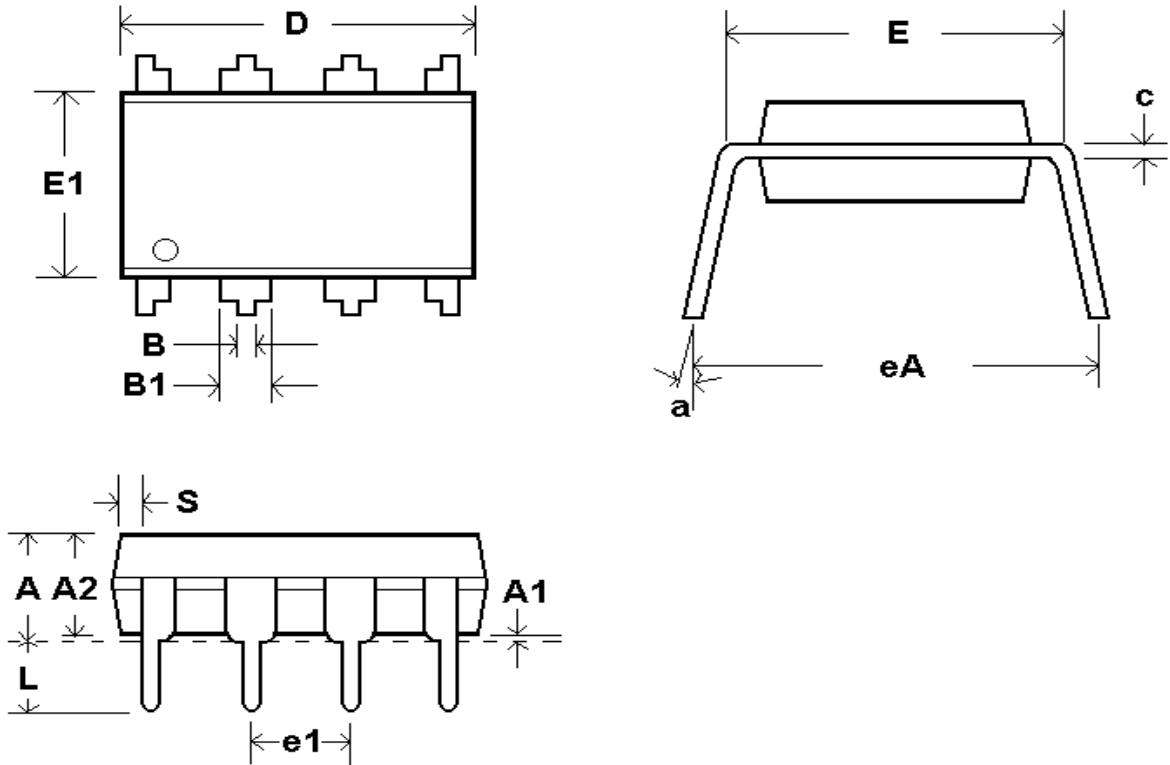

Symbol	Dimension in inch			Dimension in mm		
	Min	Typ	Max	Min	Typ	Max
A	-	-	0.210	-	-	5.33
A1	0.010	-	-	0.25	-	-
A2	0.124	0.130	0.136	3.15	3.30	3.45
B	0.013	0.018	0.023	0.33	0.46	0.58
B1	0.045	0.060	0.075	1.14	1.52	1.91
c	0.005	0.010	0.015	0.13	0.25	0.38
D	0.340	0.360	0.380	8.64	9.14	9.65
E	0.275	0.300	0.325	6.99	7.62	8.26
E1	0.240	0.250	0.260	6.10	6.35	6.60
e1	0.090	0.100	0.110	2.29	2.54	2.79
L	0.120	0.130	0.140	3.05	3.30	3.56
a	0	-	15	0	-	15
eA	0.330	0.355	0.380	8.38	9.02	9.65
S	0.015	0.030	0.045	0.38	0.76	1.44

NOTE: 1. Controlling dimension : Inch

2. General appearance spec. should be based on final visual inspection spec.