

$I_{F(AV)} = 30\text{Amp}$   
 $V_R = 30\text{V}$

**Major Ratings and Characteristics**



Characteristics	Values	Units
$I_{F(AV)}$ Rectangular waveform	30	A
$V_{RRM}$	30	V
$I_{FSM}$ @tp = 5 $\mu$ s sine	900	A
$V_F$ @15 Apk, $T_J = 125^\circ\text{C}$	0.40	V
$T_J$ range	-55 to 150	$^\circ\text{C}$

**Description/ Features**

The 32CTQ030.. Schottky rectifier series has been optimized for low reverse leakage at high temperature. The proprietary barrier technology allows for reliable operation up to 150° C junction temperature. Typical applications are in switching power supplies, converters, free-wheeling diodes, and reverse battery protection.

- 150° C  $T_J$  operation
- High purity, high temperature epoxy encapsulation for enhanced mechanical strength and moisture resistance
- Low forward voltage drop
- High frequency operation
- Guard ring for enhanced ruggedness and long term reliability
- Lead-Free ("PbF" suffix)

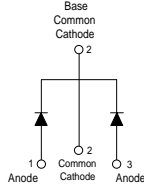
**Case Styles**

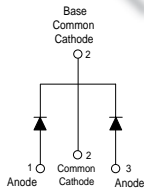
<p><b>32CTQ030SPbF</b></p>   <p><b>D<sup>2</sup>PAK</b></p>	<p><b>32CTQ030-1PbF</b></p>   <p><b>TO-262</b></p>
---	--

## Voltage Ratings

Part number	32CTQ030SPbF, 32CTQ030-1PbF
$V_R$ Max. DC Reverse Voltage (V)	30
$V_{RWM}$ Max. Working Peak Reverse Voltage (V)	

## Absolute Maximum Ratings

Parameters	32CTQ	Units	Conditions
$I_{F(AV)}$ Max. Average Forward Current * See Fig. 5	30	A	50% duty cycle @ $T_C = 115^\circ\text{C}$ , rectangular wave form
$I_{FSM}$ Max. Peak One Cycle Non-Repetitive Surge Current * See Fig. 7	900	A	5 $\mu\text{s}$ Sine or 3 $\mu\text{s}$ Rect. pulse
	250		10ms Sine or 6ms Rect. pulse
$E_{AS}$ Non-Repetitive Avalanche Energy	13	mJ	$T_J = 25^\circ\text{C}$ , $I_{AS} = 1.20$ Amps, $L = 11.10$ mH
$I_{AR}$ Repetitive Avalanche Current	3	A	Current decaying linearly to zero in 1 $\mu\text{sec}$ Frequency limited by $T_J$ max. $V_A = 1.5 \times V_R$ typical

## Electrical Specifications

Parameters	32CTQ	Units	Conditions
$V_{FM}$ Max. Forward Voltage Drop (1) * See Fig. 1	0.49	V	@ 15A
	0.58	V	@ 30A
	0.40	V	@ 15A
	0.53	V	@ 30A
$I_{RM}$ Max. Reverse Leakage Current (1) * See Fig. 2	1.75	mA	$T_J = 25^\circ\text{C}$
	97	mA	$T_J = 125^\circ\text{C}$
$V_{F(TO)}$ Threshold Voltage	0.233	V	$T_J = T_J$ max.
$r_f$ Forward Slope Resistance	9.09	m $\Omega$	
$C_T$ Max. Junction Capacitance Per Leg	1300	pF	$V_R = 5V_{DC}$ (test signal range 100Khz to 1Mhz) $25^\circ\text{C}$
$L_S$ Typical Series Inductance Per Leg	8.0	nH	Measured lead to lead 5mm from package body
dv/dt Max. Voltage Rate of Change	10000	V/ $\mu\text{s}$	(Rated $V_R$ )

(1) Pulse Width < 300 $\mu\text{s}$ , Duty Cycle < 2%

## Thermal-Mechanical Specifications

Parameters	32CTQ	Units	Conditions
$T_J$ Max. Junction Temperature Range	-55 to 150	$^\circ\text{C}$	
$T_{stg}$ Max. Storage Temperature Range	-55 to 150	$^\circ\text{C}$	
$R_{thJC}$ Max. Thermal Resistance Junction to Case Per Leg	3.25	$^\circ\text{C}/\text{W}$	DC operation * See Fig. 4
$R_{thCS}$ Typical Thermal Resistance, Case to Heatsink	0.50	$^\circ\text{C}/\text{W}$	Mounting surface, smooth and greased
wt Approximate Weight	2 (0.07)	g (oz.)	
T Mounting Torque	Min. 6 (5)	Kg-cm (lbf-in)	
	Max. 12 (10)		
Marking Device	32CTQ030S	Case style D <sup>2</sup> Pak	
	32CTQ030-1	Case style TO-262	

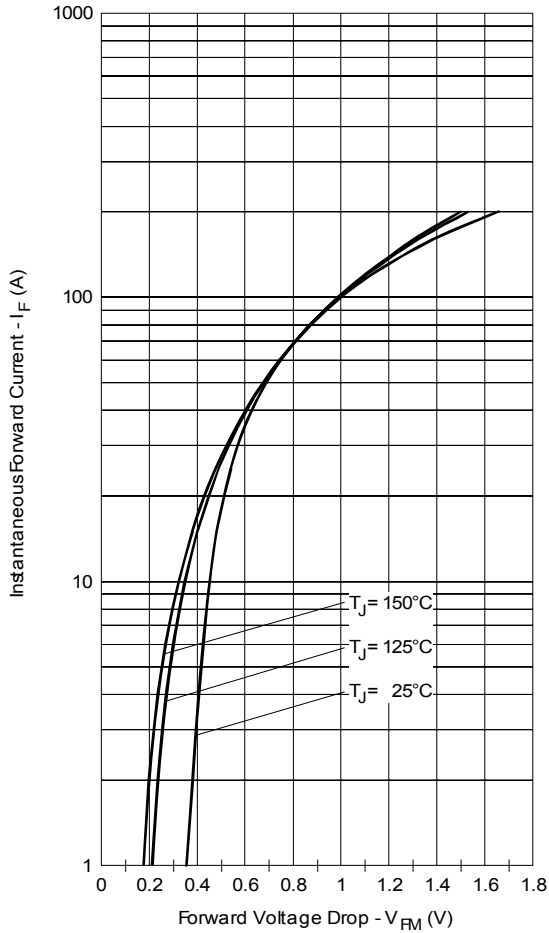

Fig. 1 - Maximum Forward Voltage Drop Characteristics

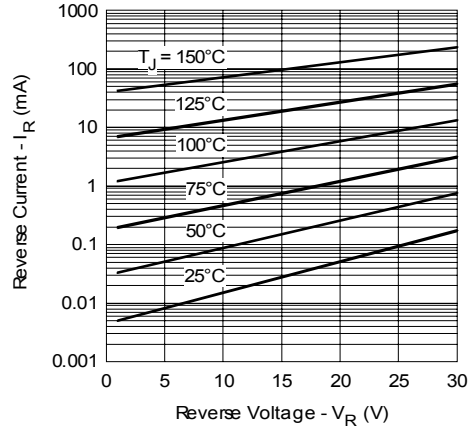

Fig. 2 - Typical Values of Reverse Current Vs. Reverse Voltage

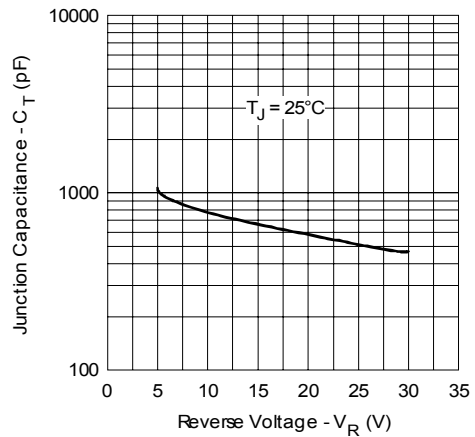

Fig. 3 - Typical Junction Capacitance Vs. Reverse Voltage

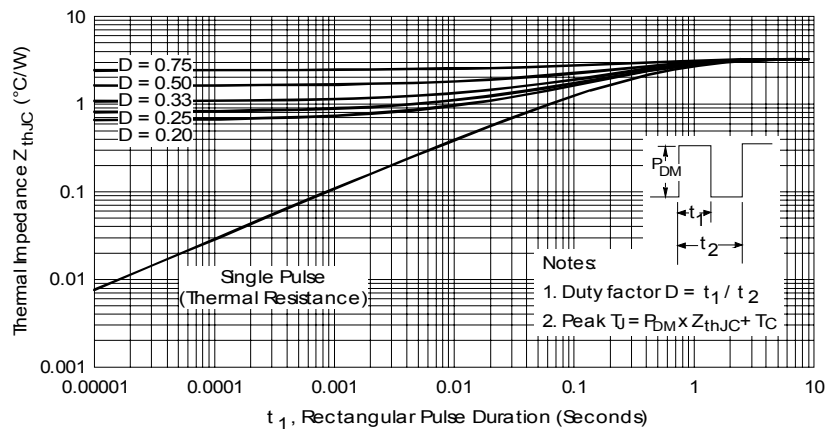

Fig. 4 - Maximum Thermal Impedance  $Z_{thJC}$  Characteristics

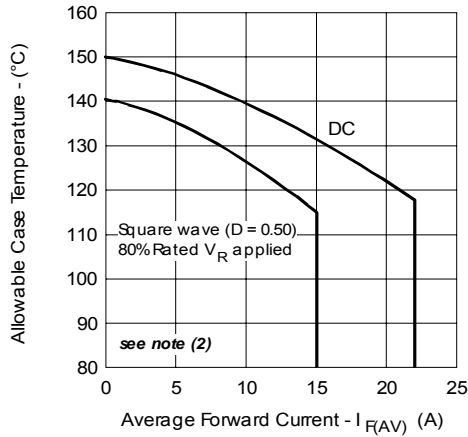

Fig. 5- Maximum Allowable Case Temperature Vs. Average Forward Current

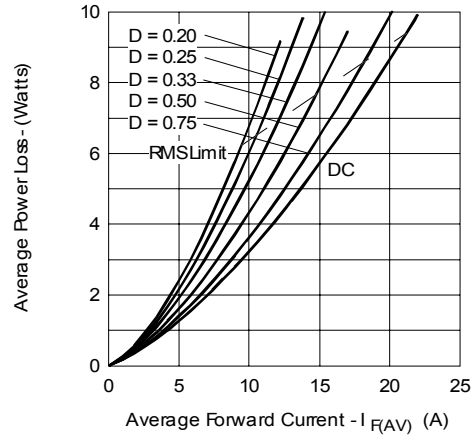

Fig. 6- Forward Power Loss Characteristics

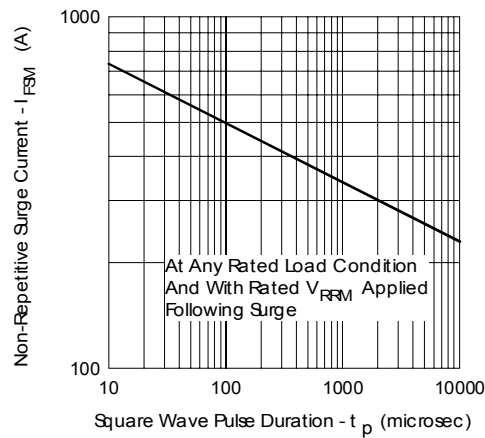

Fig. 7- Maximum Non-Repetitive Surge Current

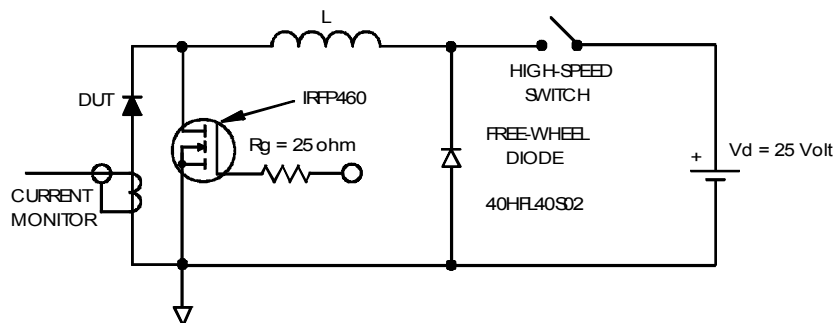
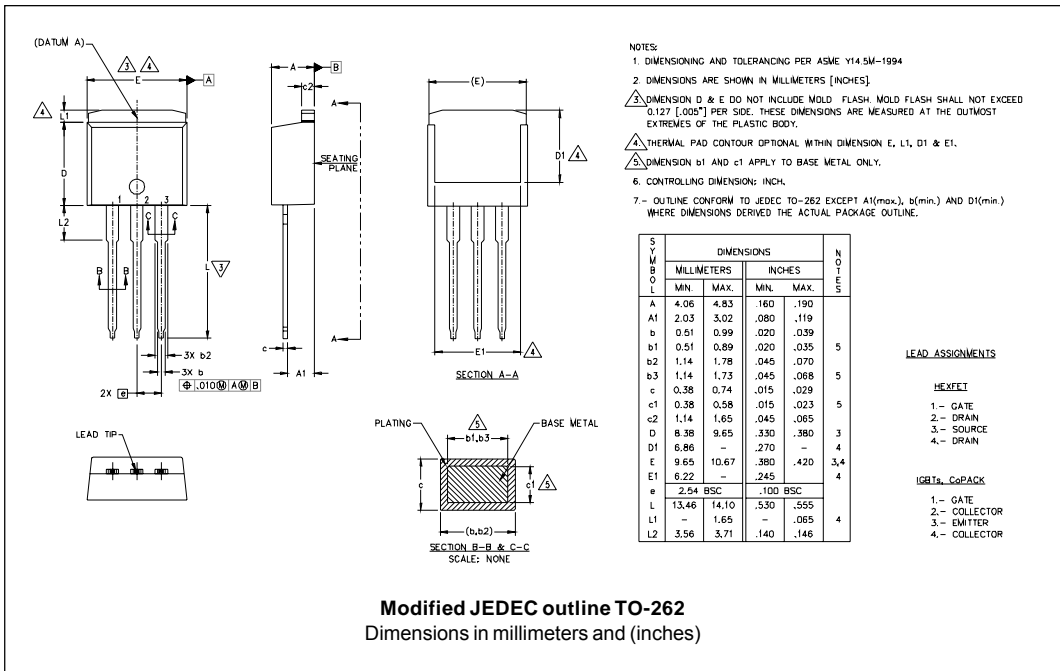
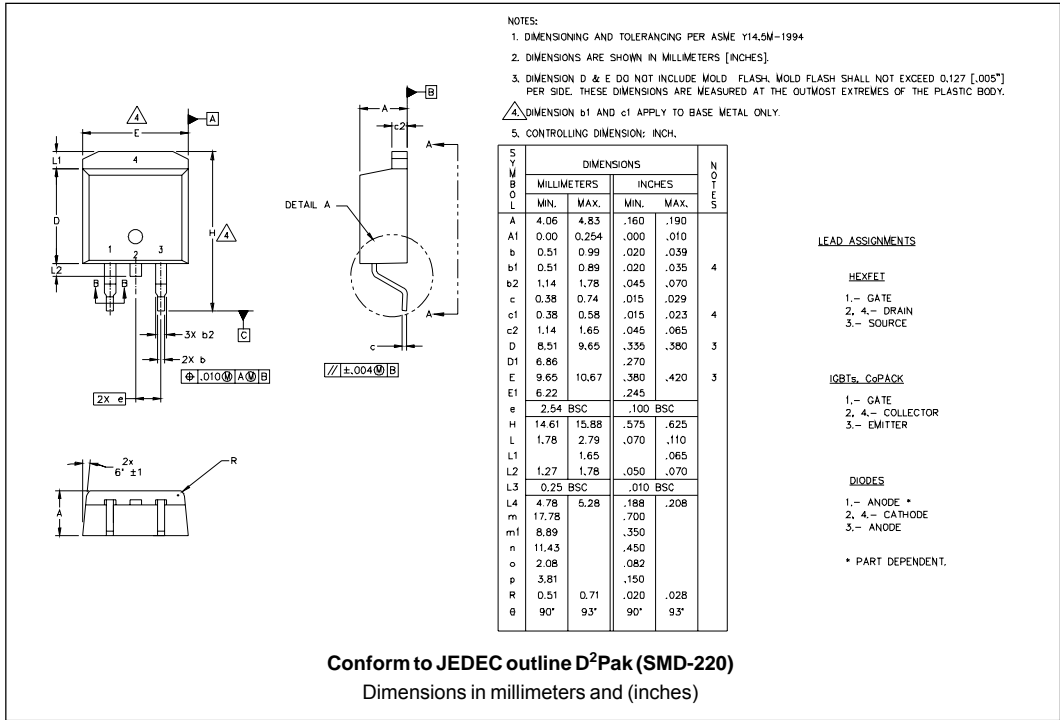

Fig. 8- Unclamped Inductive Test Circuit

- (2) Formula used:  $T_C = T_J - (Pd + Pd_{REV}) \times R_{thJC}$ ;  
 $Pd = \text{Forward Power Loss} = I_{F(AV)} \times V_{FM} @ (I_{F(AV)} / D)$  (see Fig. 6);  
 $Pd_{REV} = \text{Inverse Power Loss} = V_{R1} \times I_R (1 - D)$ ;  $I_R @ V_{R1} = 80\% \text{ rated } V_R$

Outlines Table



Part Marking Information

**D<sup>2</sup>PAK**

EXAMPLE: THIS IS A 32CTQ030S  
LOT CODE 8024  
ASSEMBLED ON WW 02, 2000

Note: "P" in assembly line position indicates "Lead-Free"

INTERNATIONAL RECTIFIER LOGO

ASSEMBLY LOT CODE

PART NUMBER

DATE CODE

YEAR 0 = 2000  
WEEK 02  
P = LEAD-FREE

**TO-262**

EXAMPLE: THIS IS A 32CTQ030-1  
LOT CODE 1789  
ASSEMBLED ON WW 19, 2002

Note: "P" in assembly line position indicates "Lead-Free"

INTERNATIONAL RECTIFIER LOGO

ASSEMBLY LOT CODE

PART NUMBER

DATE CODE

YEAR 2 = 2002  
WEEK 19  
P = LEAD-FREE

Tape & Reel Information

SECTION Y-Y

Ao	10.50	+/- 0.1
Bo	15.80	+/- 0.1
B2	10.25	+/- 0.1
Ko	4.90	+/- 0.1
F	11.50	+/- 0.1
P1	16.00	+/- 0.1
W	24.00	+/- 0.3

NOTES:

- 1.0 SPROCKET HOLE PITCH CUMULATIVE TOLERANCE ±.02
- 2.0 CAMBER NOT TO EXCEED 1mm in 100mm
- 3.0 MATERIAL: CONDUCTIVE BLACK STYRENIC ALLOY
- 4.0 Ko MEASURED FROM A PLANE ON THE INSIDE BOTTOM OF THE POCKET TO THE TOP SURFACE OF THE CARRIER
- 5.0 MEASURED FROM CENTRELINE OF SPROCKET HOLE TO CENTRELINE OF POCKET
- 6.0 VENDOR: (OPTIONAL)
- 7.0 MUST ALSO MEET REQUIREMENTS OF EIA STANDAR #EIA-481A TAPING OF SURFACE MOUNT COMPONENTS FOR AUTOMATIC PLACEMENT
- 8.0 SURFACE RESISTIVITY OF MOLDED MATL. MUST MEASURE LESS OR EQUAL TO 10<sup>6</sup> OHMS PER SQUARE, MEASURED IN ACCORDANCE TO PROCEDURE GIVEN IN ASTM D-257 & ASTM D-991
- 9.0 TOTAL LENGTH PER REEL MUST BE 45 METERS
- 10.0 Ⓢ CRITICAL

Dimensions in millimeters and (inches)

Ordering Information Table

Device Code																	
	<table border="1" style="margin: auto;"> <tr> <td style="padding: 5px;"><b>32</b></td> <td style="padding: 5px;"><b>C</b></td> <td style="padding: 5px;"><b>T</b></td> <td style="padding: 5px;"><b>Q</b></td> <td style="padding: 5px;"><b>030</b></td> <td style="padding: 5px;"><b>S</b></td> <td style="padding: 5px;"><b>TRL</b></td> <td style="padding: 5px;"><b>PbF</b></td> </tr> <tr> <td style="text-align: center;">①</td> <td style="text-align: center;">②</td> <td style="text-align: center;">③</td> <td style="text-align: center;">④</td> <td style="text-align: center;">⑤</td> <td style="text-align: center;">⑥</td> <td style="text-align: center;">⑦</td> <td style="text-align: center;">⑧</td> </tr> </table>	<b>32</b>	<b>C</b>	<b>T</b>	<b>Q</b>	<b>030</b>	<b>S</b>	<b>TRL</b>	<b>PbF</b>	①	②	③	④	⑤	⑥	⑦	⑧
<b>32</b>	<b>C</b>	<b>T</b>	<b>Q</b>	<b>030</b>	<b>S</b>	<b>TRL</b>	<b>PbF</b>										
①	②	③	④	⑤	⑥	⑦	⑧										
<b>1</b>	- Current Rating (30A)																
<b>2</b>	- Circuit Configuration C = Common Cathode																
<b>3</b>	- T = TO-220																
<b>4</b>	- Schottky "Q" Series																
<b>5</b>	- Voltage Rating (030 = 30V)																
<b>6</b>	- <ul style="list-style-type: none"> <li>• S = D<sup>2</sup>Pak</li> <li>• -1= TO-262</li> </ul>																
<b>7</b>	- <ul style="list-style-type: none"> <li>• none = Tube (50 pieces)</li> <li>• TRL = Tape &amp; Reel (Left Oriented - for D<sup>2</sup>Pak only)</li> <li>• TRR = Tape &amp; Reel (Right Oriented - for D<sup>2</sup>Pak only)</li> </ul>																
<b>8</b>	- <ul style="list-style-type: none"> <li>• none = Standard Production</li> <li>• PbF = Lead-Free</li> </ul>																

Data and specifications subject to change without notice.  
 This product has been designed and qualified for Industrial Level and Lead-Free.  
 Qualification Standards can be found on IR's Web site.