



**ECG941, ECG941D,
ECG941M**
INTERNALLY-COMPENSATED
OPERATIONAL AMPLIFIER

Features:

- No Frequency Compensation Required
- Short-Circuit Protection
- Offset Voltage Null Capability
- Large Common-Mode and Differential Voltage Ranges
- Low Power Consumption
- No Latch Up

General Description - High performance monolithic operational amplifier constructed on a single silicon chip. It is intended for a wide range of analog applications. High common mode voltage range and absence of "latch-up" tendencies make it ideal for use as a voltage follower. The high gain and wide range of operating voltages provide superior performance in integrator, summing amplifier, and general feedback applications. The device is short-circuit protected and requires no external components for frequency compensation. The internal 6 dB/octave roll-off insures stability in closed loop applications.

Absolute Maximum Ratings

- Supply Voltage ±18 V
- Internal Power Dissipation (Note 1)
 - Metal Can 500 mW
 - Plastic & Mini DIP 310 mW
- Differential Input Voltage ±30 V
- Input Voltage (Note 2) ±15 V
- Storage Temperature Range
 - Metal Can, Plastic & Mini DIP, ... -55°C to +125°C
 - Operating Temperature Range 0° C to +70° C
- Lead Temperature (Soldering)
 - Metal Can (60 seconds) 300° C
 - Plastic & Mini DIP (10 seconds) .. 260° C
- Output Short Circuit Duration (Note 3) Indefinite

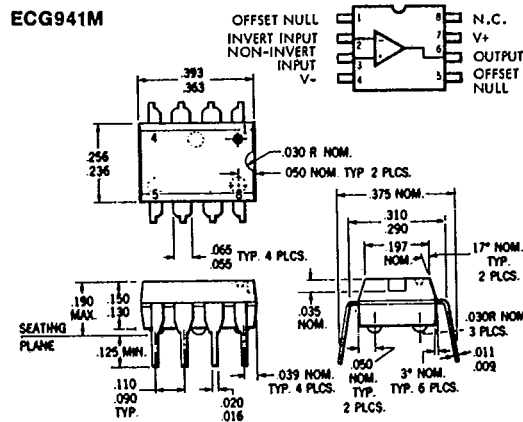
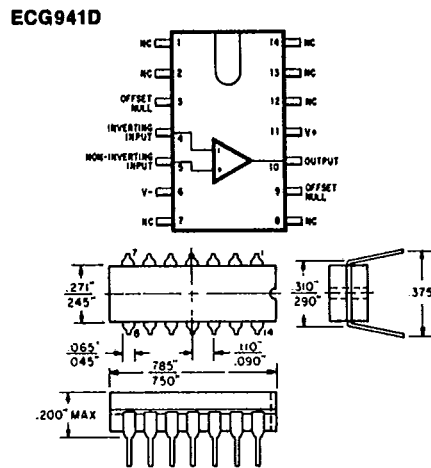
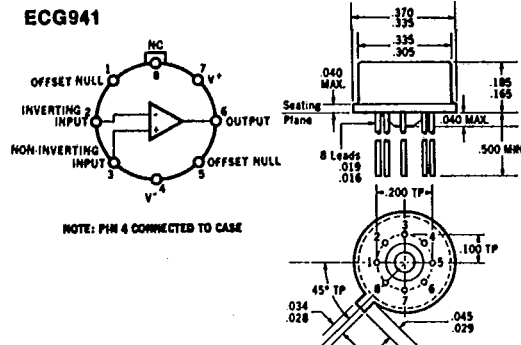

EQUIVALENT CIRCUIT

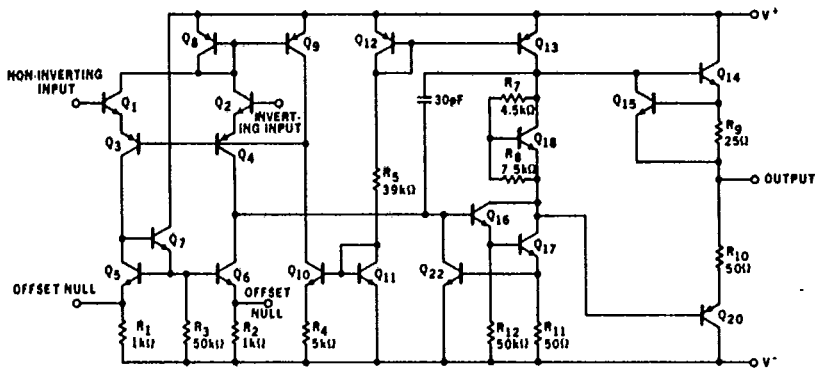

ELECTRICAL CHARACTERISTICS ($V_S = \pm 15V$, $T_A = 25^\circ C$ unless otherwise specified)

PARAMETERS (see definitions)	CONDITIONS	MIN.	TYP.	MAX.	UNITS
Input Offset Voltage	$R_S \leq 10 k\Omega$		2.0	6.0	mV
Input Offset Current			20	200	nA
Input Bias Current			80	500	nA
Input Resistance		0.3	2.0		M Ω
Input Capacitance			1.4		pF
Offset Voltage Adjustment Range			± 15		mV
Input Voltage Range		± 12	± 13		V
Common Mode Rejection Ratio	$R_S \leq 10 k\Omega$	70	90		dB
Supply Voltage Rejection Ratio	$R_S \leq 10 k\Omega$		30	150	$\mu V/V$
Large-Signal Voltage Gain	$R_L \geq 2 k\Omega$, $V_{out} = \pm 10V$	20,000	200,000		
Output Voltage Swing	$R_L \geq 10 k\Omega$	± 12	± 14		V
	$R_L \geq 2 k\Omega$	± 10	± 13		V
Output Resistance			75		Ω
Output Short-Circuit Current			25		mA
Supply Current			1.7	2.8	mA
Power Consumption			50	85	mW
Transient Response (unity gain)	$V_{in} = 20 mV$, $R_L = 2 k\Omega$, $C_L \leq 100 pF$				
Risettime			0.3		μs
Overshoot			5.0		%
Slew Rate	$R_L \geq 2 k\Omega$		0.5		V/ μs
The following specifications apply for $0^\circ C \leq T_A \leq +70^\circ C$:					
Input Offset Voltage				7.5	mV
Input Offset Current				300	nA
Input Bias Current				800	nA
Large-Signal Voltage Gain	$R_L \geq 2 k\Omega$, $V_{out} = \pm 10V$	15,000			
Output Voltage Swing	$R_L \geq 2 k\Omega$	± 10	± 13		V

TYPICAL PERFORMANCE CURVES

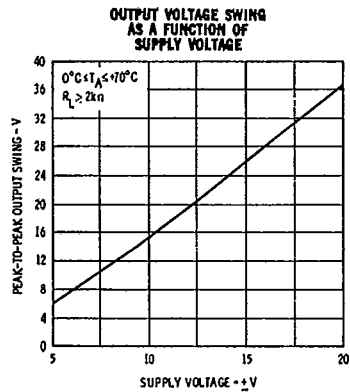
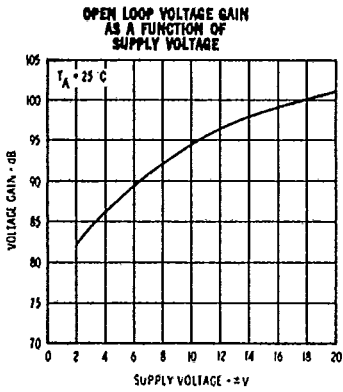

TYPICAL PERFORMANCE CURVES

INPUT COMMON MODE VOLTAGE RANGE AS A FUNCTION OF SUPPLY VOLTAGE

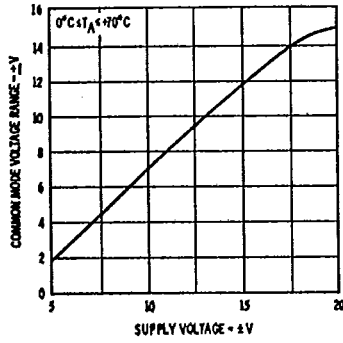

POWER CONSUMPTION AS A FUNCTION OF SUPPLY VOLTAGE

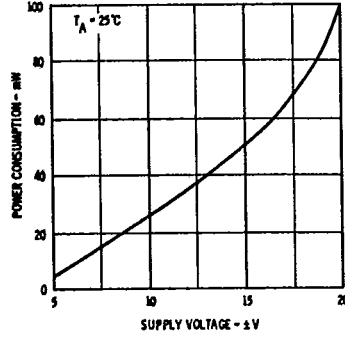

INPUT BIAS CURRENT AS A FUNCTION OF AMBIENT TEMPERATURE

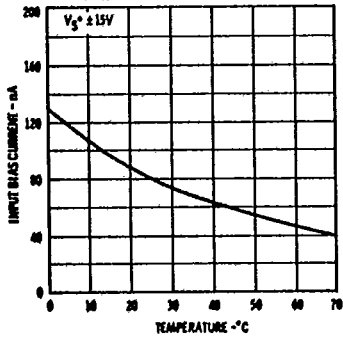

INPUT RESISTANCE AS A FUNCTION OF AMBIENT TEMPERATURE

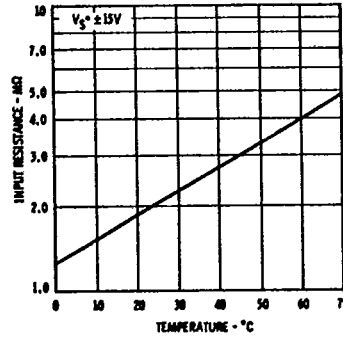

INPUT OFFSET CURRENT AS A FUNCTION OF SUPPLY VOLTAGE

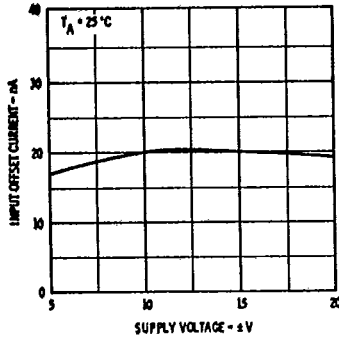

INPUT OFFSET CURRENT AS A FUNCTION OF AMBIENT TEMPERATURE

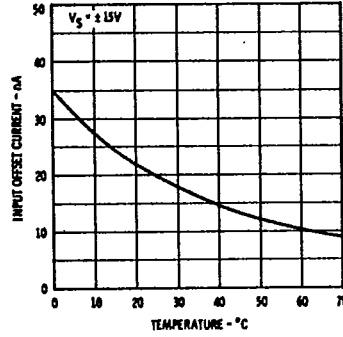

POWER CONSUMPTION AS A FUNCTION OF AMBIENT TEMPERATURE

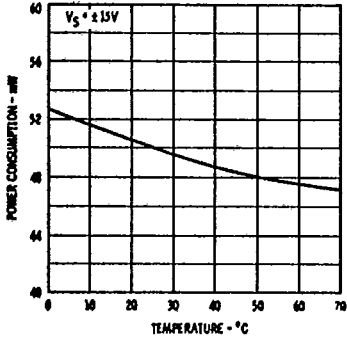

OUTPUT VOLTAGE SWING AS A FUNCTION OF LOAD RESISTANCE

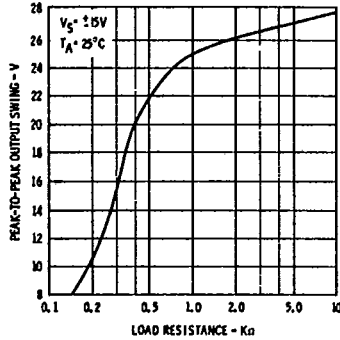

OUTPUT SHORT-CIRCUIT CURRENT AS A FUNCTION OF AMBIENT TEMPERATURE

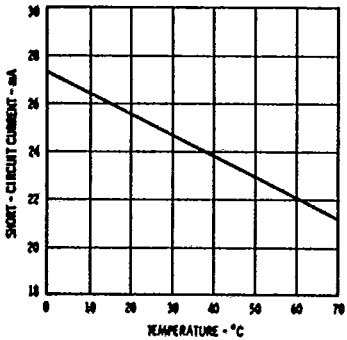

ABSOLUTE MAXIMUM POWER DISSIPATION AS A FUNCTION OF AMBIENT TEMPERATURE

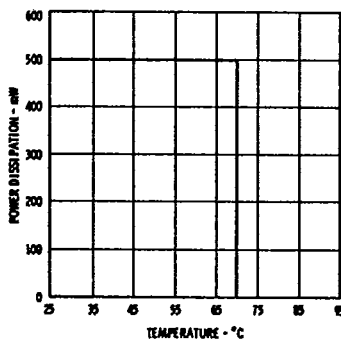

INPUT NOISE VOLTAGE AS A FUNCTION OF FREQUENCY

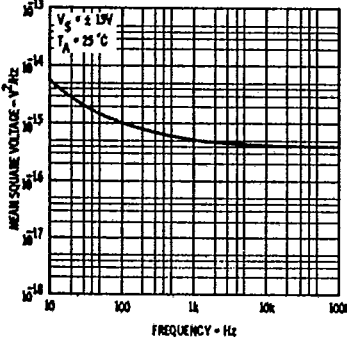

INPUT NOISE CURRENT AS A FUNCTION OF FREQUENCY

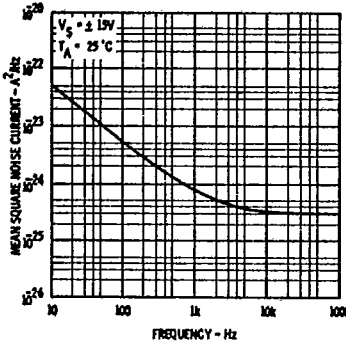

TYPICAL PERFORMANCE CURVES

BROADBAND NOISE FOR VARIOUS BANDWIDTHS

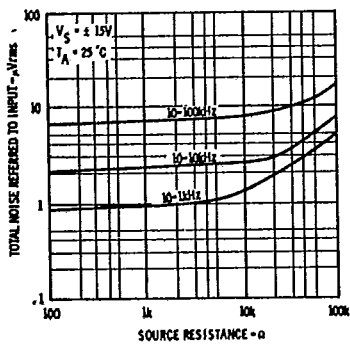

OPEN LOOP VOLTAGE GAIN AS A FUNCTION OF FREQUENCY

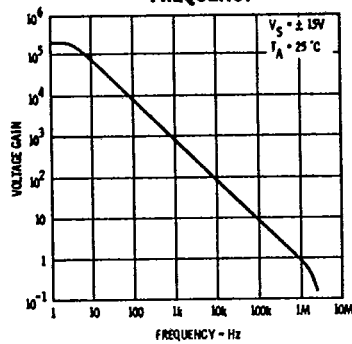

OPEN LOOP PHASE RESPONSE AS A FUNCTION OF FREQUENCY

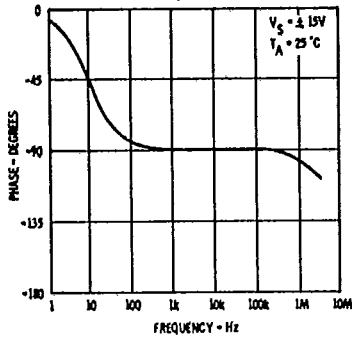

OUTPUT VOLTAGE SWING AS A FUNCTION OF FREQUENCY

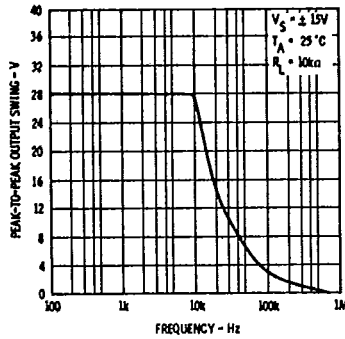

INPUT RESISTANCE AND INPUT CAPACITANCE AS A FUNCTION OF FREQUENCY

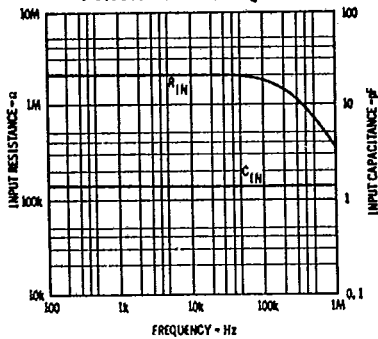

OUTPUT RESISTANCE AS A FUNCTION OF FREQUENCY

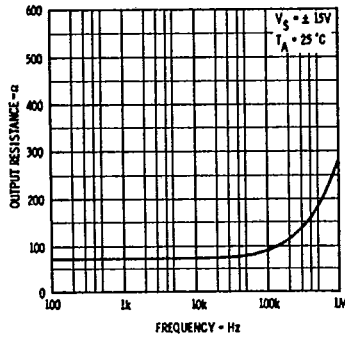

COMMON MODE REJECTION RATIO AS A FUNCTION OF FREQUENCY

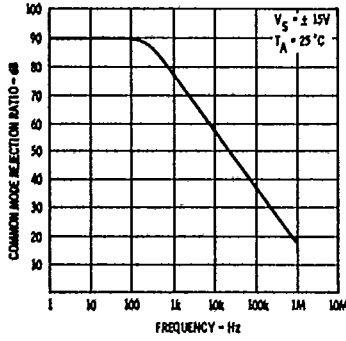

TRANSIENT RESPONSE

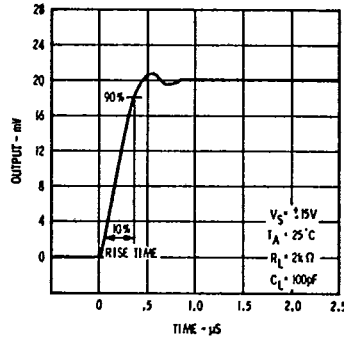

TRANSIENT TEST CIRCUIT

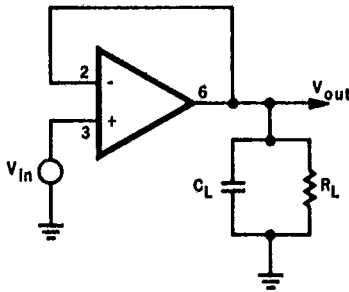

VOLTAGE FOLLOWER LARGE-SIGNAL PULSE RESPONSE

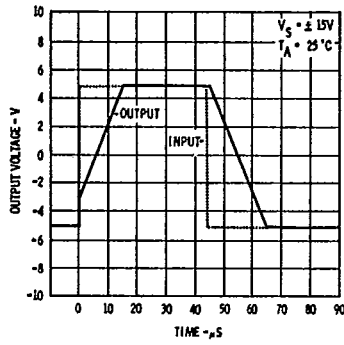

FREQUENCY CHARACTERISTICS AS A FUNCTION OF SUPPLY VOLTAGE

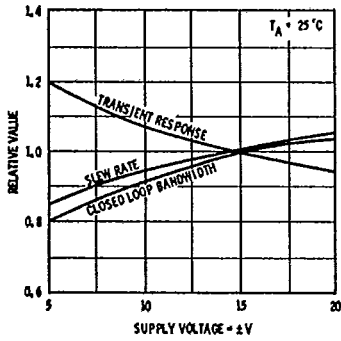

VOLTAGE OFFSET NULL CIRCUIT

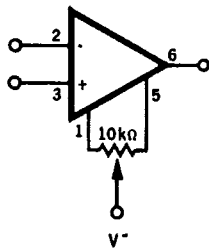

FREQUENCY CHARACTERISTICS AS A FUNCTION OF AMBIENT TEMPERATURE

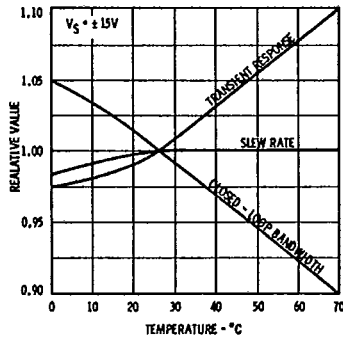

TYPICAL APPLICATIONS

UNITY-GAIN VOLTAGE FOLLOWER

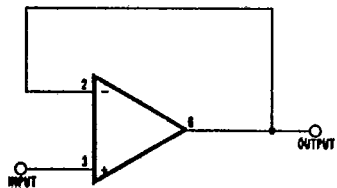

$R_{IN} = 400 \text{ M}\Omega$
 $C_{IN} = 1 \text{ pF}$
 $R_{out} < 1 \Omega$
 $B.W. = 1 \text{ MHz}$

NON-INVERTING AMPLIFIER

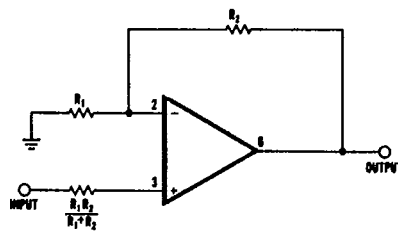

GAIN	R_1	R_2	B.W.	R_{IN}
10	1 k Ω	9 k Ω	100 kHz	400 M Ω
100	100 Ω	9.9 k Ω	10 kHz	280 M Ω
1000	100 Ω	99.9 k Ω	1 kHz	80 M Ω

INVERTING AMPLIFIER

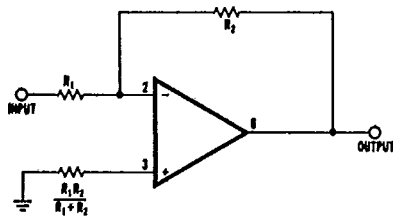

GAIN	R_1	R_2	B.W.	R_{IN}
1	10 k Ω	10 k Ω	1 MHz	10 k Ω
10	1 k Ω	10 k Ω	100 kHz	1 k Ω
100	1 k Ω	100 k Ω	10 kHz	1 k Ω
1000	100 Ω	100 k Ω	1 kHz	100 Ω

CLIPPING AMPLIFIER

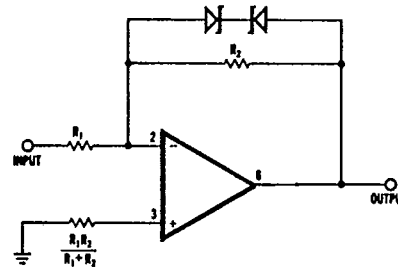

$$\frac{E_{out}}{E_{in}} = \frac{R_2}{R_1} \text{ if } |E_{out}| \leq V_z + 0.7 \text{ V}$$

where V_z = Zener breakdown voltage

SIMPLE INTEGRATOR

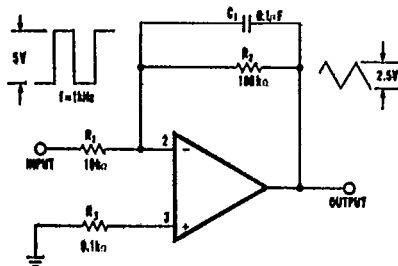

$$E_{out} = -\frac{1}{R_1 C_1} \int E_{in} dt$$

SIMPLE DIFFERENTIATOR

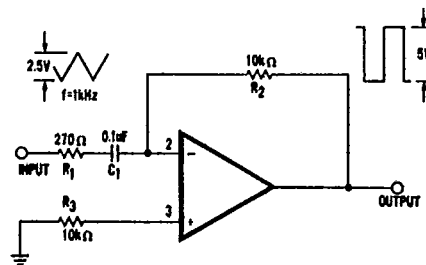

$$E_{out} = -R_1 C_1 \frac{dE_{in}}{dt}$$

TYPICAL APPLICATIONS

LOW DRIFT LOW NOISE AMPLIFIER

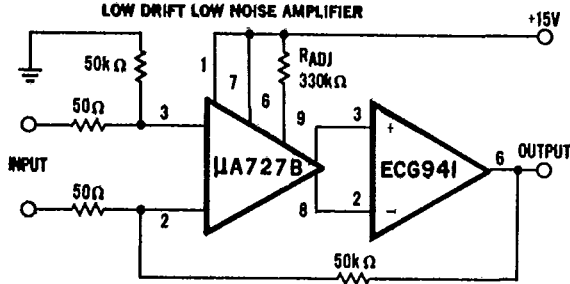

Voltage Gain = 10³
 Input Offset Voltage Drift = 0.6 μV/°C
 Input Offset Current Drift = 2.0 pA/°C

HIGH SLEW RATE POWER AMPLIFIER

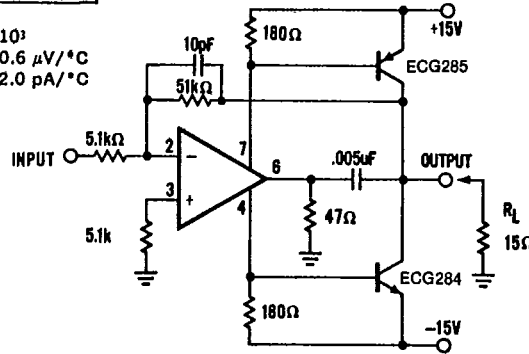

NOTCH FILTER USING THE ECG941 AS A GYRATOR

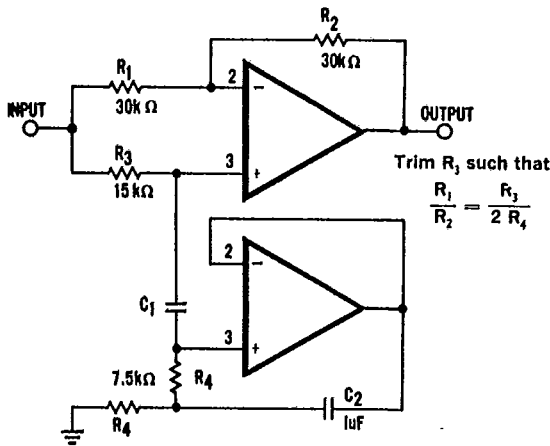

NOTCH FREQUENCY AS A FUNCTION OF C₁

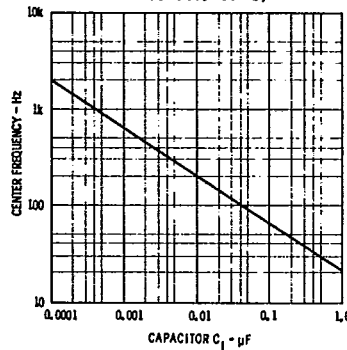

DEFINITION OF TERMS

- INPUT OFFSET VOLTAGE** — That voltage which must be applied between the input terminals to obtain zero output voltage. The input offset voltage may also be defined for the case where two equal resistances are inserted in series with the input leads.
- INPUT OFFSET CURRENT** — The difference in the currents into the two input terminals with the output at zero volts.
- INPUT BIAS CURRENT** — The average of the two input currents.
- INPUT RESISTANCE** — The resistance looking into either input terminal with the other grounded.
- INPUT CAPACITANCE** — The capacitance looking into either input terminal with the other grounded.
- LARGE-SIGNAL VOLTAGE GAIN** — The ratio of the maximum output voltage swing with load to the change in input voltage required to drive the output from zero to this voltage.
- OUTPUT RESISTANCE** — The resistance seen looking into the output terminal with the output at null. This parameter is defined only under small signal conditions at frequencies above a few hundred cycles to eliminate the influence of drift and thermal feedback.
- OUTPUT SHORT-CIRCUIT CURRENT** — The maximum output current available from the amplifier with the output shorted to ground or to either supply.
- SUPPLY CURRENT** — The DC current from the supplies required to operate the amplifier with the output at zero and with no load current.
- POWER CONSUMPTION** — The DC power required to operate the amplifier with the output at zero and with no load current.
- TRANSIENT RESPONSE** — The closed-loop step-function response of the amplifier under small-signal conditions.
- INPUT VOLTAGE RANGE** — The range of voltage which, if exceeded on either input terminal, could cause the amplifier to cease functioning properly.
- INPUT COMMON MODE REJECTION RATIO** — The ratio of the input voltage range to the maximum change in input offset voltage over this range.
- SUPPLY VOLTAGE REJECTION RATIO** — The ratio of the change in input offset voltage to the change in supply voltage producing it.
- OUTPUT VOLTAGE SWING** — The peak output swing, referred to zero, that can be obtained without clipping.