

GL390/GL390V

Thin Bow Type Resin Mold Package Infrared Emitting Diodes

■ Features

- Thin bow type resin mold package
(Resin area : 2.0 x 3.1 x 5.2 mm)
- Low peak forward voltage (**GL390V**)
 V_{FM} : TYP. 1.9V at $I_{FM}=0.5A$

■ Applications

- Cameras
- Infrared remote controllers

■ Outline Dimensions

(Unit : mm)

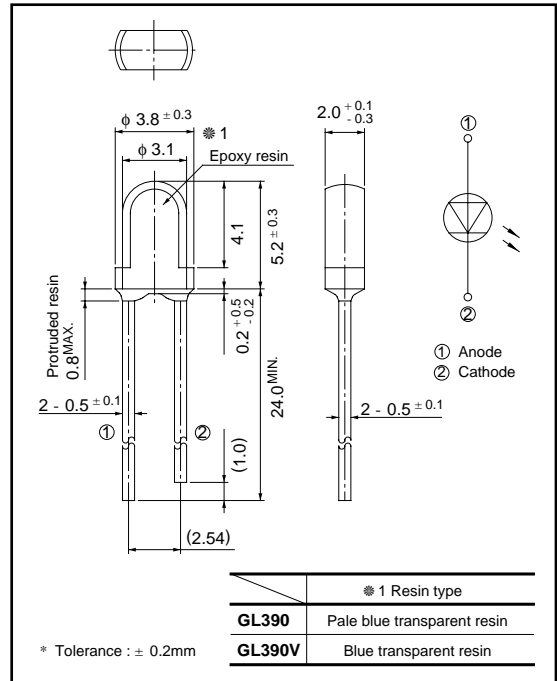

■ Model Lineup

Model	GL390	GL390V
Radiant intensity (mW/sr)	TYP. 13	TYP. 16
Half intensity angle (°)	TYP. ± 18	

■ Absolute Maximum Ratings

(Ta=25°C)

Parameter	Symbol	Rating	Unit
Forward current	I_F	60	mA
*1 Peak forward current	I_{FM}	1	A
Reverse voltage	V_R	6	V
Power dissipation	P	150	mW
Operating temperature	T_{opr}	- 25 to 85	°C
Storage temperature	T_{stg}	- 40 to 85	°C
*2 Soldering temperature	T_{sol}	260	°C

*1 Pulse width ≤ 100μs, Duty ratio=0.01

*2 For 3 seconds at the position of 2.6 mm from the resin edge

Electro-optical Characteristics

(Ta=25°C)

Parameter	Symbol	Conditions	MIN.	TYP.	MAX.	Unit
Forward voltage	V_F	$I_F = 50\text{mA}$	-	1.3	1.5	V
Peak forward voltage	GL390	$I_{FM} = 0.5\text{A}$	-	2.2	3.5	V
	GL390V		-	1.9	3.0	
Reverse current	I_R	$V_R = 3\text{V}$	-	-	10	μA
*3 Radiant intensity	GL390	$I_F = 50\text{mA}$	7	13	-	mW/sr
	GL390V		9	16	-	
Peak emission wavelength	λ_P	$I_F = 5\text{mA}$	-	950	-	nm
Half intensity wavelength	$\Delta\lambda$	$I_F = 5\text{mA}$	-	45	-	nm
Terminal capacitance	GL390	$V_R = 0\text{ f} = 1\text{MHz}$	-	70	-	pF
	GL390V		-	50	-	
Response frequency	f_c		-	300	-	kHz
Half intensity angle	$\Delta\theta$	$I_F = 20\text{mA}$	-	± 18	-	°

*3 I_E : Value obtained by converting the value in power of radiant fluxes emitted at the solid angle of 0.01 sr (steradian) in the direction of mechanical axis of the lens portion into 1 sr or all those emitted from the light emitting diode.

Fig. 1 Forward Current vs. Ambient Temperature

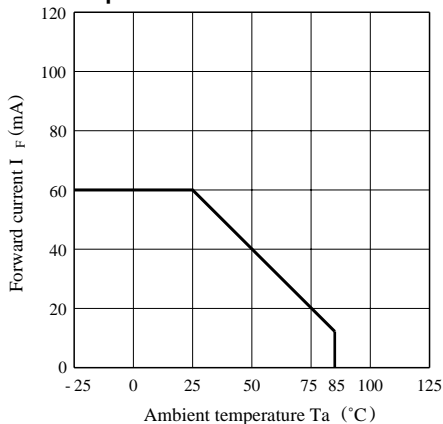

Fig. 2 Peak Forward Current vs. Duty Ratio

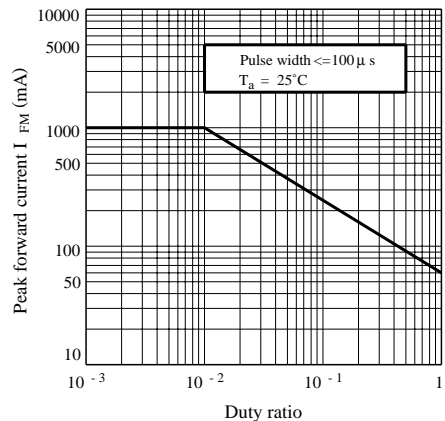

Fig. 3 Spectral Distribution

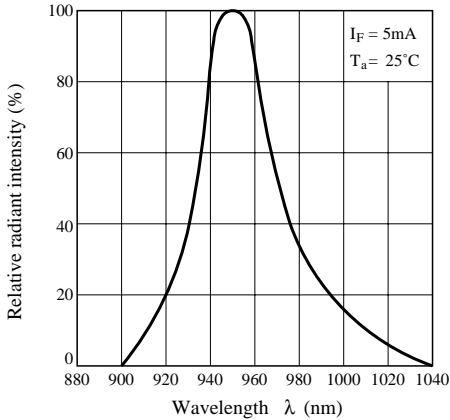

Fig. 4 Peak Emission Wavelength vs. Ambient Temperature

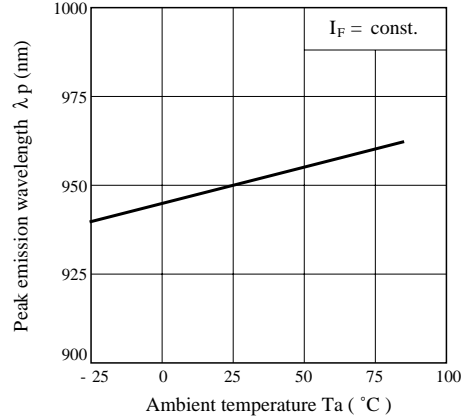

Fig. 5-1 Forward Current vs. Forward Voltage (GL390)

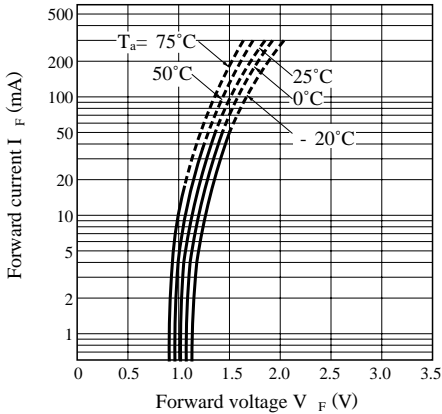

Fig. 5-2 Forward Current vs. Forward Voltage (GL390V)

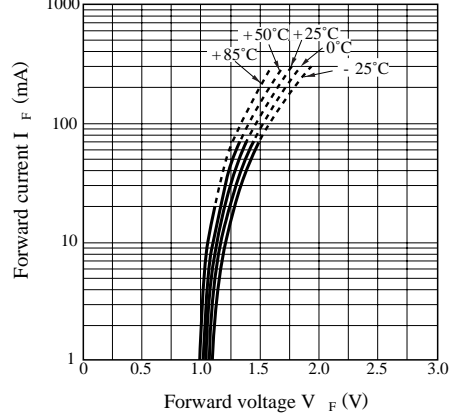

Fig. 6 Relative Radiant Flux vs. Ambient Temperature

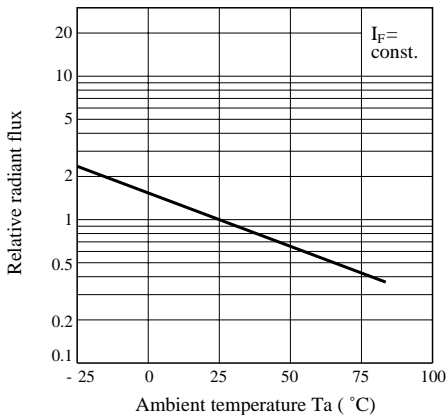

Fig. 7 Radiant Intensity vs. Forward Current

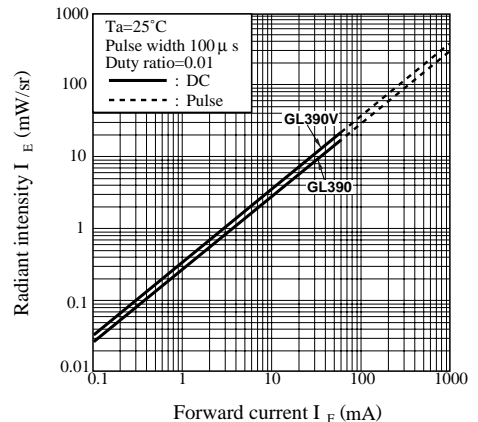

Fig. 8-1 Radiation Diagram (Horizontal Direction)

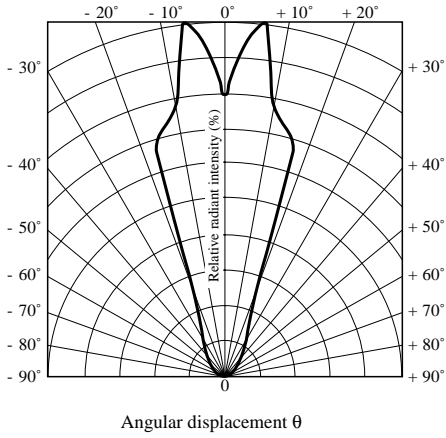
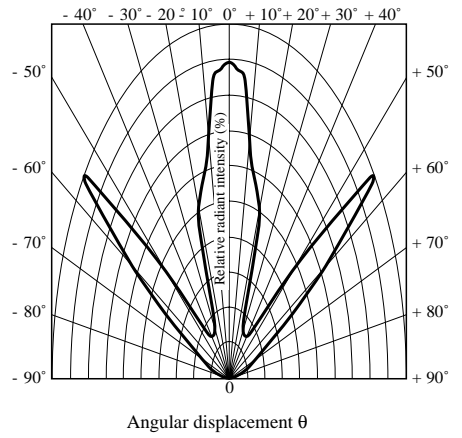

Fig. 8-2 Radiation Diagram (Vertical Direction)



● Please refer to the chapter "Precautions for Use". (Page 78 to 93)