

# UNR411x Series (UN411x Series)

## Silicon PNP epitaxial planar type

For digital circuits

### ■ Features

- Costs can be reduced through downsizing of the equipment and reduction of the number of parts
- New S type package, allowing supply with the radial taping

### ■ Resistance by Part Number

	(R <sub>1</sub> )	(R <sub>2</sub> )
• UNR4110 (UN4110)	47 kΩ	—
• UNR4111 (UN4111)	10 kΩ	10 kΩ
• UNR4112 (UN4112)	22 kΩ	22 kΩ
• UNR4113 (UN4113)	47 kΩ	47 kΩ
• UNR4114 (UN4114)	10 kΩ	47 kΩ
• UNR4115 (UN4115)	10 kΩ	—
• UNR4116 (UN4116)	4.7 kΩ	—
• UNR4117 (UN4117)	22 kΩ	—
• UNR4118 (UN4118)	0.51 kΩ	5.1 kΩ
• UNR4119 (UN4119)	1 kΩ	10 kΩ
• UNR411D (UN411D)	47 kΩ	10 kΩ
• UNR411E (UN411E)	47 kΩ	22 kΩ
• UNR411F (UN411F)	4.7 kΩ	10 kΩ
• UNR411H (UN411H)	2.2 kΩ	10 kΩ
• UNR411L (UN411L)	4.7 kΩ	4.7 kΩ
• UNR411M	2.2 kΩ	47 kΩ
• UNR411N	4.7 kΩ	47 kΩ

### ■ Absolute Maximum Ratings T<sub>a</sub> = 25°C

Parameter	Symbol	Rating	Unit
Collector-base voltage (Emitter open)	V <sub>CBO</sub>	-50	V
Collector-emitter voltage (Base open)	V <sub>CEO</sub>	-50	V
Collector current	I <sub>C</sub>	-100	mA
Total power dissipation	P <sub>T</sub>	300	mW
Junction temperature	T <sub>j</sub>	150	°C
Storage temperature	T <sub>stg</sub>	-55 to +150	°C

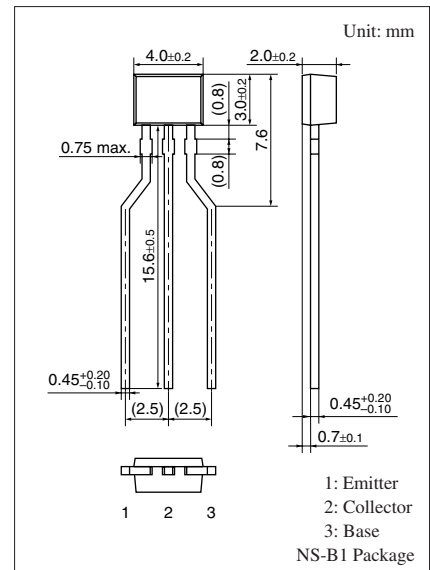

### Internal Connection

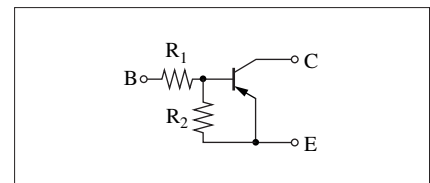

Note) The part numbers in the parenthesis show conventional part number.

**■ Electrical Characteristics**  $T_a = 25^\circ\text{C} \pm 3^\circ\text{C}$ 

Parameter		Symbol	Conditions	Min	Typ	Max	Unit
Collector-base voltage (Emitter open)		$V_{CBO}$	$I_C = -10 \mu\text{A}, I_E = 0$	-50			V
Collector-emitter voltage (Base open)		$V_{CEO}$	$I_C = -2 \text{ mA}, I_B = 0$	-50			V
Collector-base cutoff current (Emitter open)		$I_{CBO}$	$V_{CB} = -50 \text{ V}, I_E = 0$			-0.1	$\mu\text{A}$
Collector-emitter cutoff current (Base open)		$I_{CEO}$	$V_{CE} = -50 \text{ V}, I_B = 0$			-0.5	$\mu\text{A}$
Emitter-base cutoff current (Collector open)	UNR4110/4115/4116/4117	$I_{EBO}$	$V_{EB} = -6 \text{ V}, I_C = 0$			-0.01	mA
	UNR4113					-0.1	
	UNR4112/4114/411D/ 411E/411M/411N					-0.2	
	UNR4111					-0.5	
	UNR411F/411H					-1.0	
	UNR4119					-1.5	
	UNR4118/411L					-2.0	
Forward current transfer ratio	UNR4118/411L	$h_{FE}$	$V_{CE} = -10 \text{ V}, I_C = -5 \text{ mA}$	20			—
	UNR4119/411D/411F/411H			30			
	UNR4111			35			
	UNR4112/411E			60			
	UNR4113/4114/411M			80			
	UNR411N			80	400		
	UNR4110*/4115*/4116*/ 4117*			160	460		
Collector-emitter saturation voltage		$V_{CE(sat)}$	$I_C = -10 \text{ mA}, I_B = -0.3 \text{ mA}$			-0.25	V
Output voltage high-level		$V_{OH}$	$V_{CC} = -5 \text{ V}, V_B = -0.5 \text{ V}, R_L = 1 \text{ k}\Omega$	-4.9			V
Output voltage low-level		$V_{OL}$	$V_{CC} = -5 \text{ V}, V_B = -2.5 \text{ V}, R_L = 1 \text{ k}\Omega$			-0.2	V
			$V_{CC} = -5 \text{ V}, V_B = -3.5 \text{ V}, R_L = 1 \text{ k}\Omega$				
			$V_{CC} = -5 \text{ V}, V_B = -10 \text{ V}, R_L = 1 \text{ k}\Omega$				
			$V_{CC} = -5 \text{ V}, V_B = -6 \text{ V}, R_L = 1 \text{ k}\Omega$				
Transition frequency		$f_T$	$V_{CB} = -10 \text{ V}, I_E = 1 \text{ mA}, f = 200 \text{ MHz}$		80		MHz
Input resistance	UNR4118	$R_1$		-30%	0.51	+30%	k $\Omega$
	UNR4119				1.0		
	UNR411H/411M				2.2		
	UNR4116/411F/411L/411N				4.7		
	UNR4111/4114/4115				10		
	UNR4112/4117				22		
	UNR4110/4113/411D/411E				47		

Note) 1. Measuring methods are based on JAPANESE INDUSTRIAL STANDARD JIS C 7030 measuring methods for transistors.

2. \*: Rank classification

Rank	Q	R	S	No-rank
$h_{FE}$	160 to 260	210 to 340	290 to 460	160 to 460

■ Electrical Characteristics (continued)  $T_a = 25^\circ\text{C} \pm 3^\circ\text{C}$

Parameter	Symbol	Conditions	Min	Typ	Max	Unit
Resistance ratio	UNR411M	$R_1/R_2$		0.047		—
	UNR411N			0.1		
	UNR4118/4119		0.08	0.10	0.12	
	UNR4114		0.17	0.21	0.25	
	UNR411H		0.17	0.22	0.27	
	UNR411F		0.37	0.47	0.57	
	UNR4111/4112/4113/411L		0.8	1.0	1.2	
	UNR411E		1.70	2.14	2.60	
UNR411D	3.7	4.7	5.7			

Note) Measuring methods are based on JAPANESE INDUSTRIAL STANDARD JIS C 7030 measuring methods for transistors.

Common characteristics chart

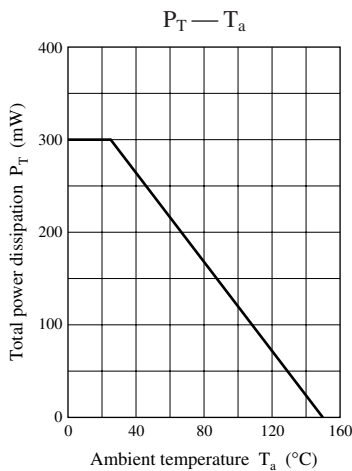

Characteristics charts of UNR4110

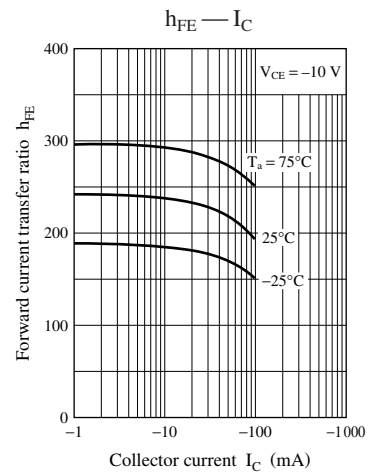
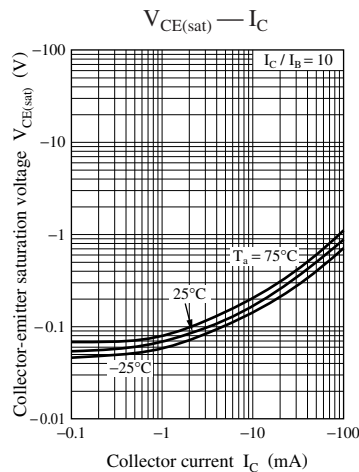
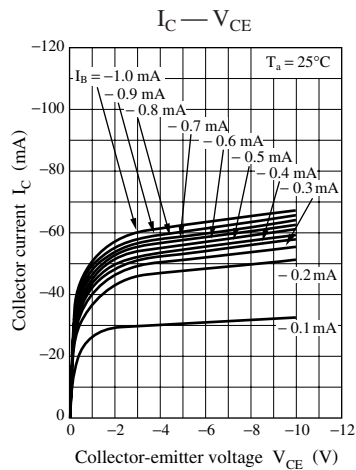

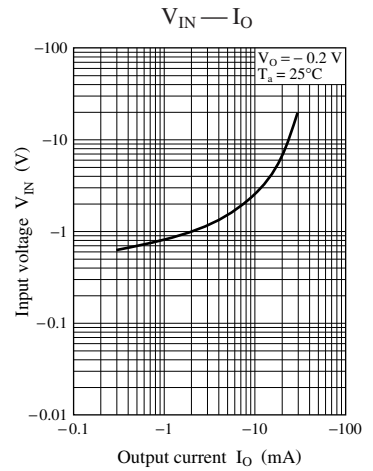
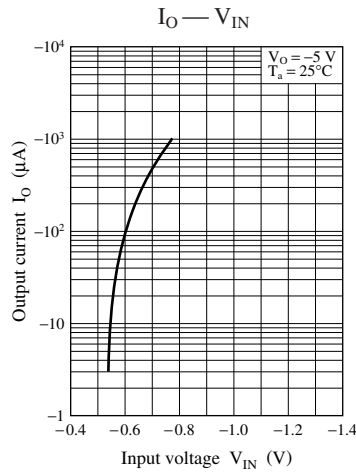
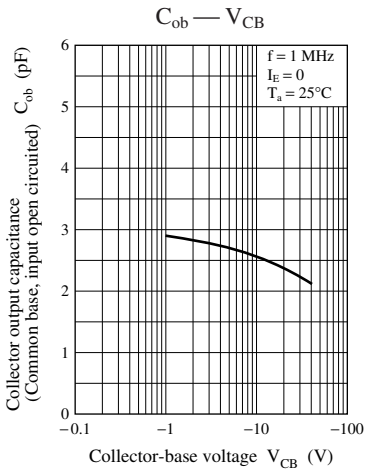

Characteristics charts of UNR4111

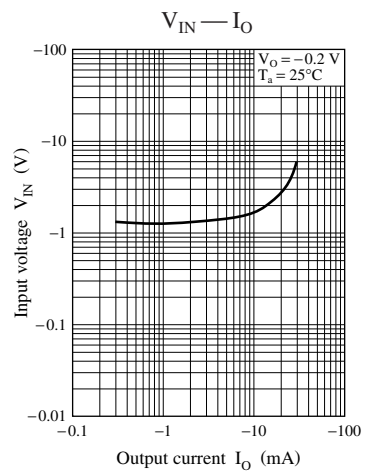
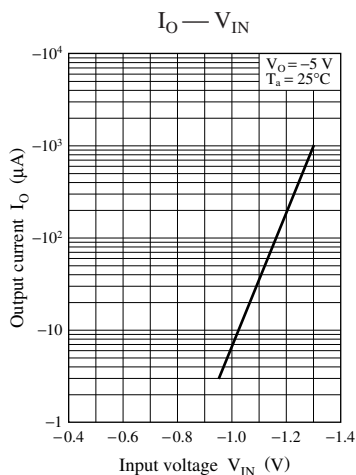
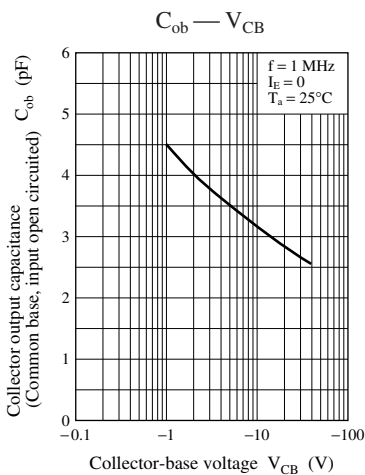
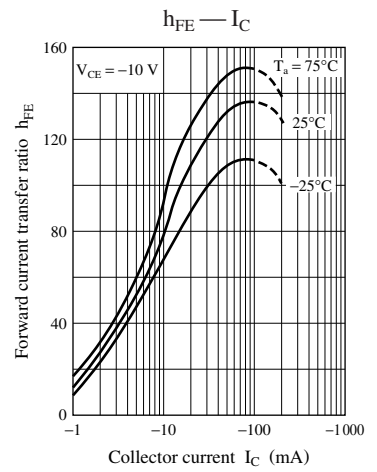
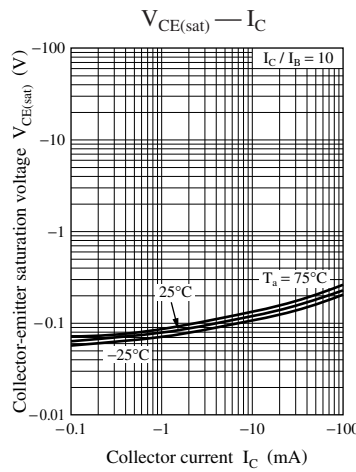
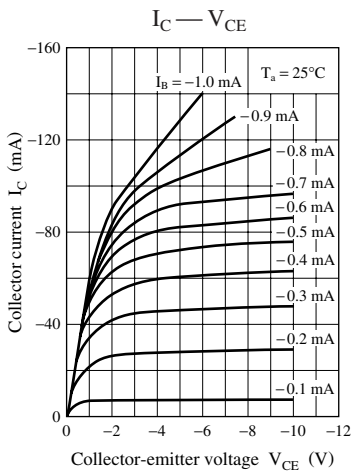

Characteristics charts of UNR4112

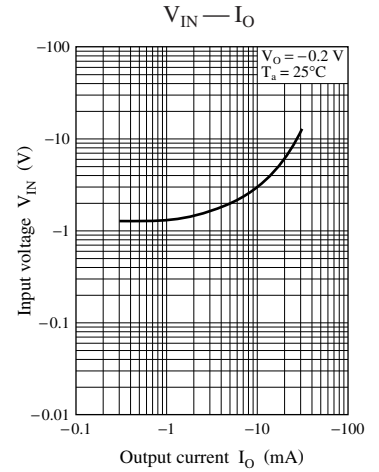
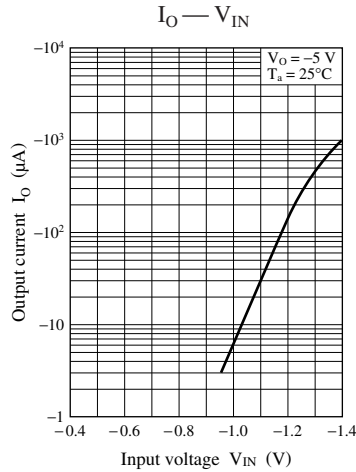
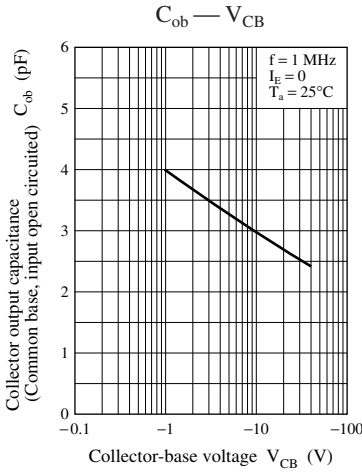
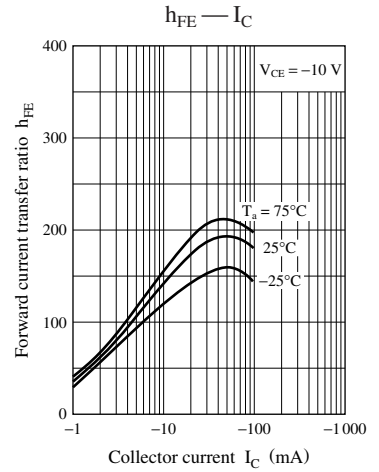
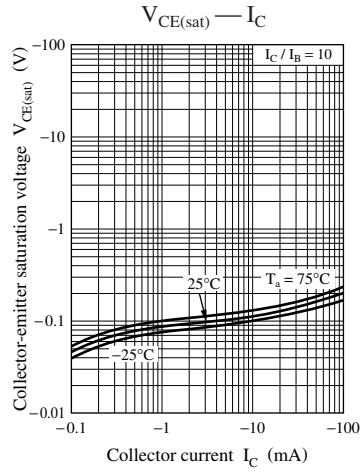
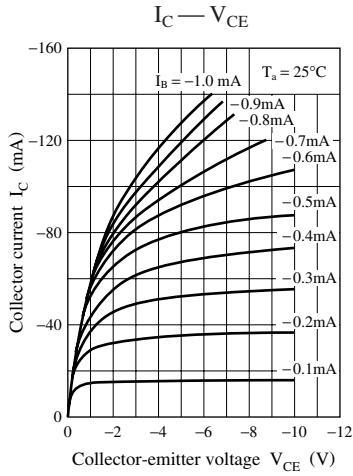

Characteristics charts of UNR4113

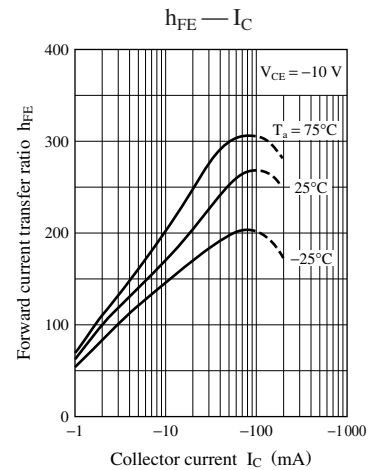
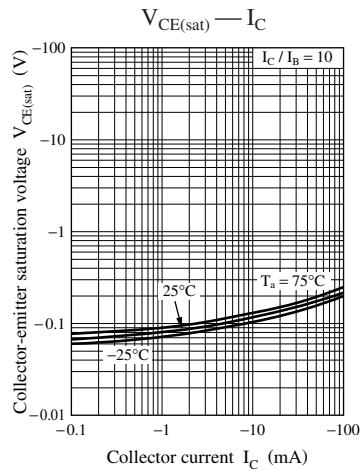
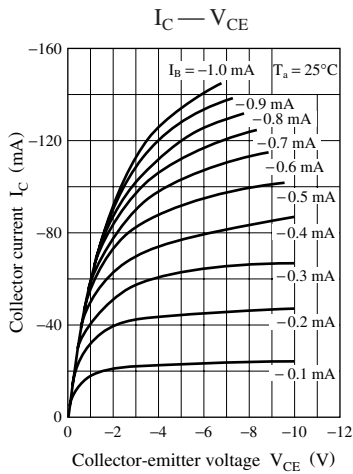

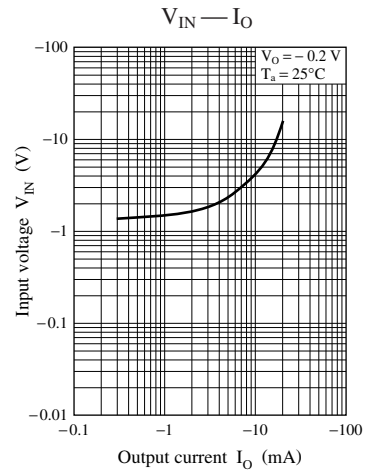
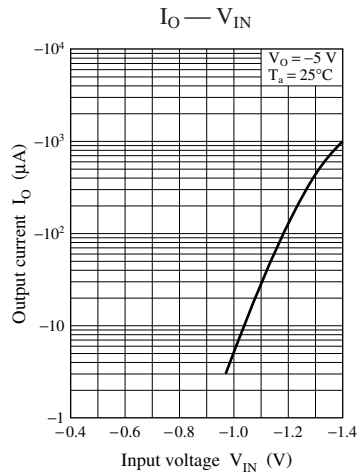
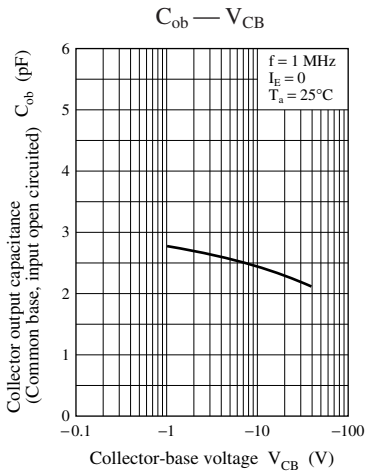

Characteristics charts of UNR4114

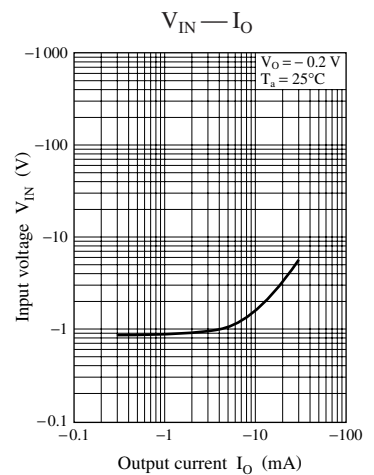
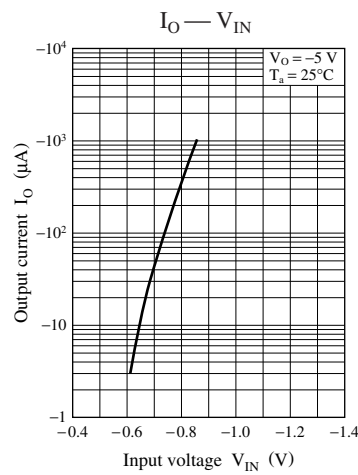
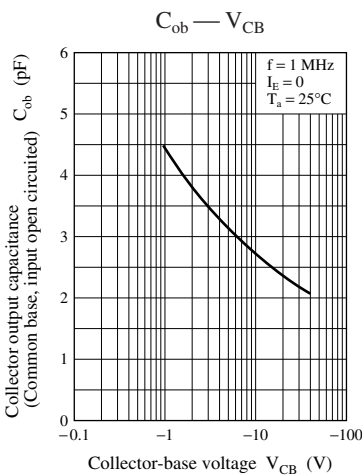
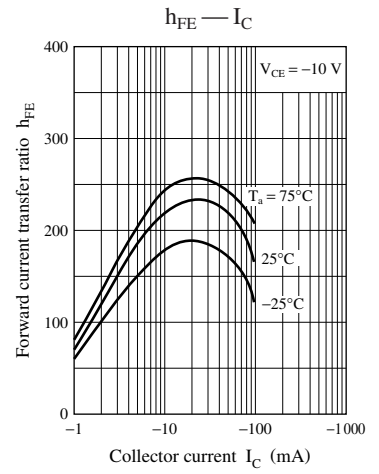
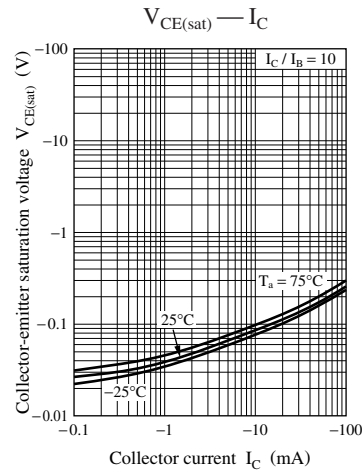
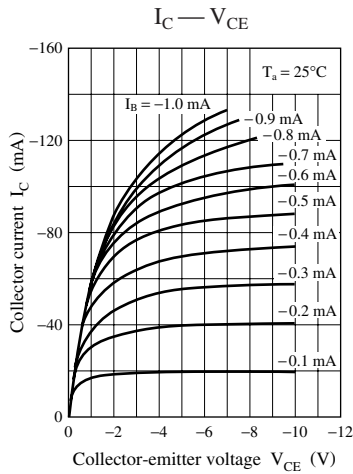

Characteristics charts of UNR4115

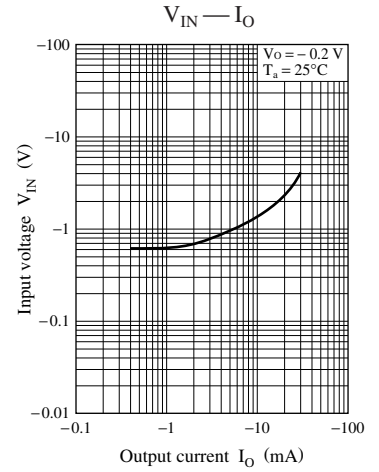
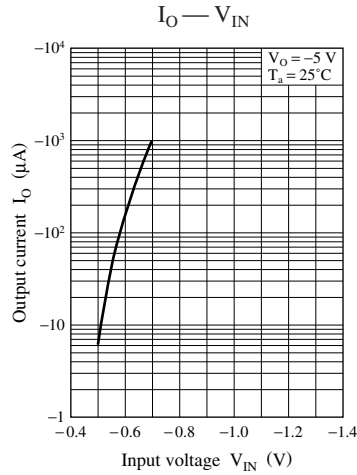
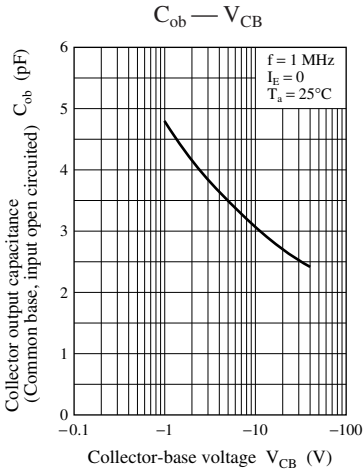
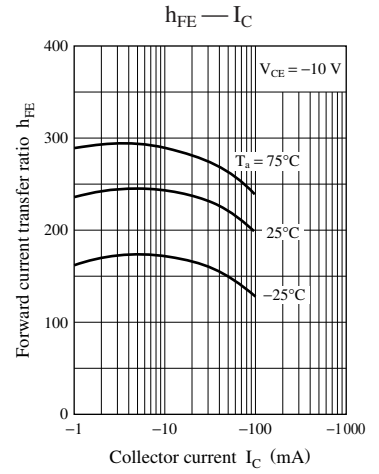
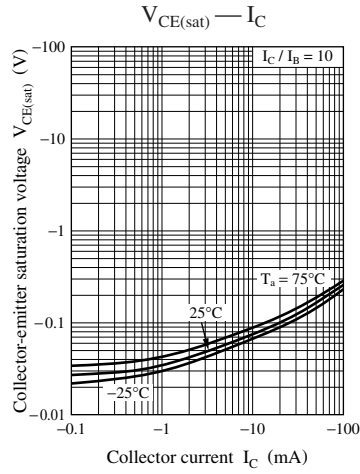
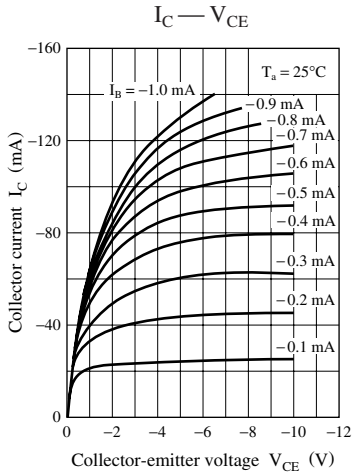

Characteristics charts of UNR4116

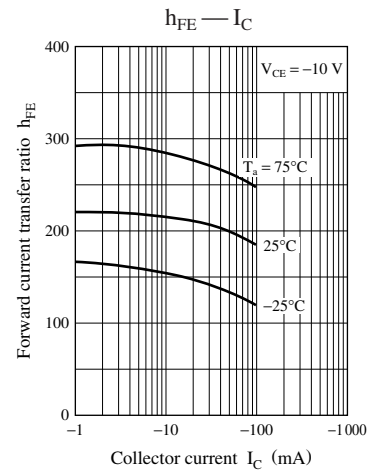
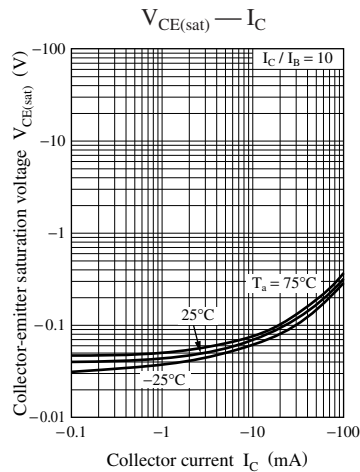
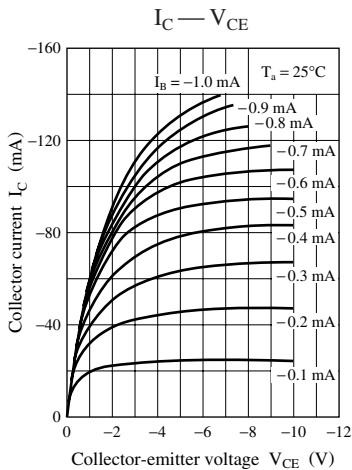

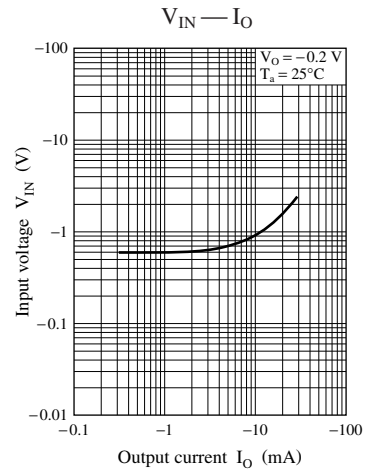
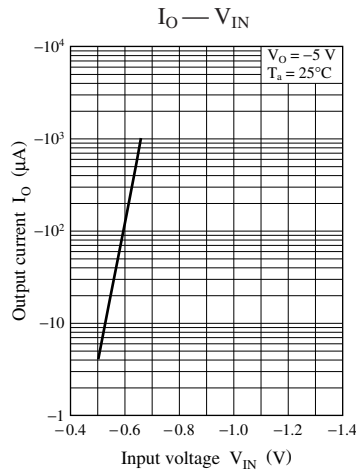
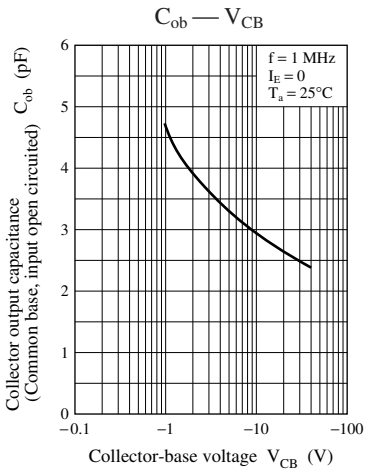

Characteristics charts of UNR4117

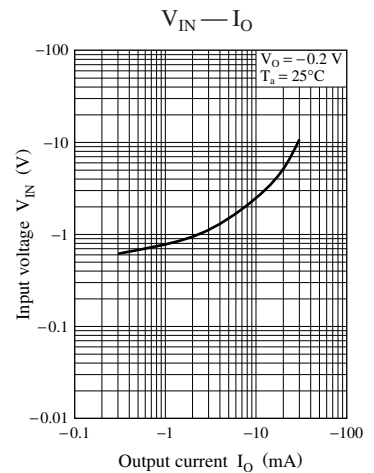
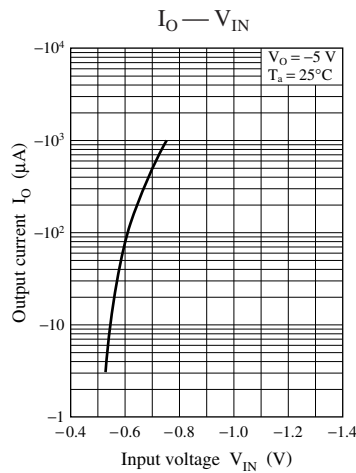
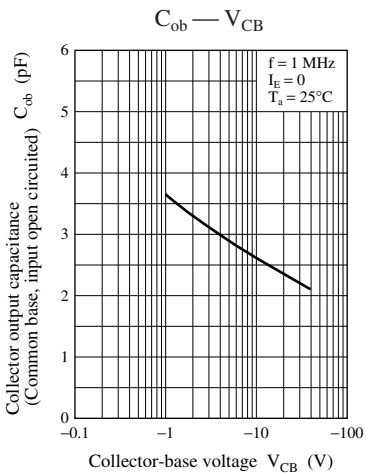
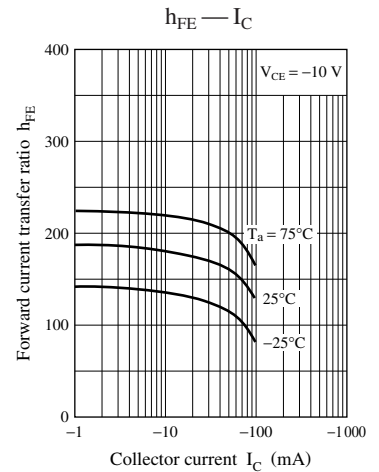
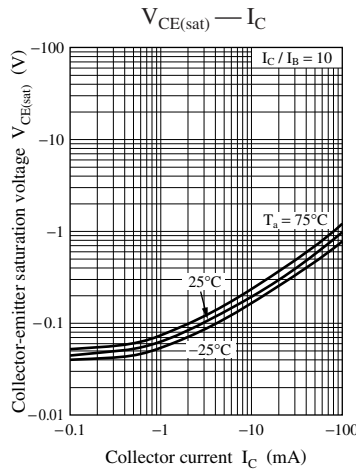
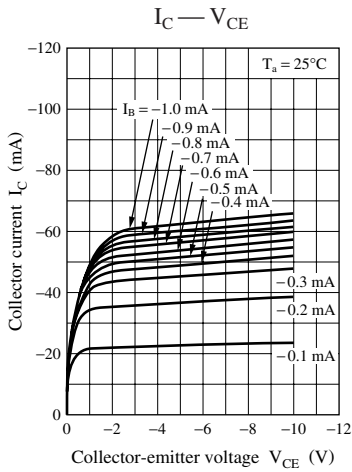



Characteristics charts of UNR4118

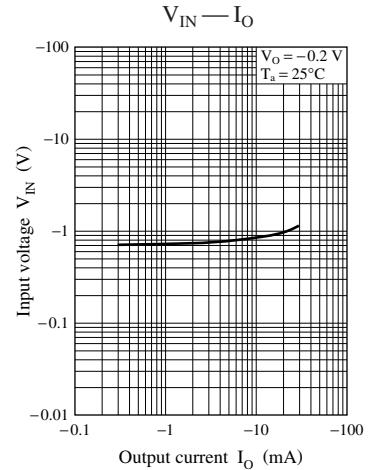
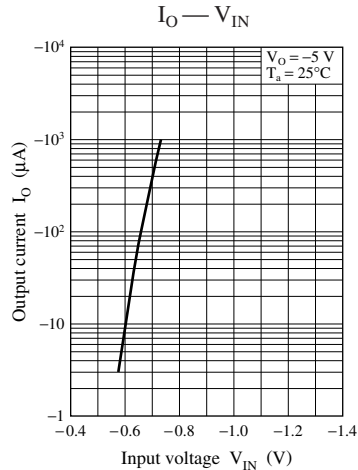
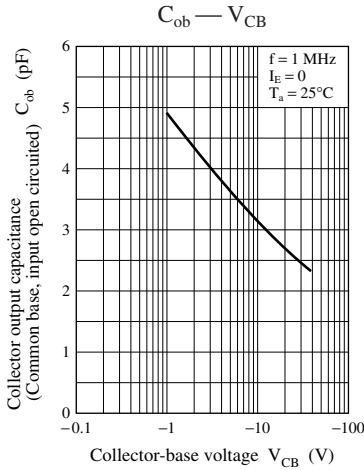
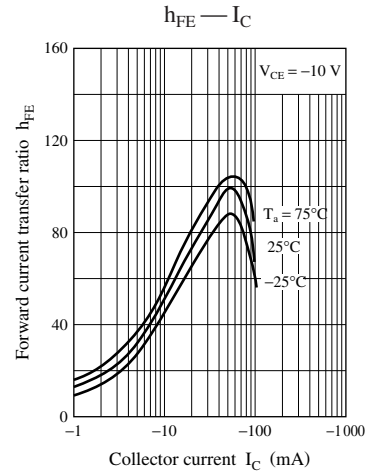
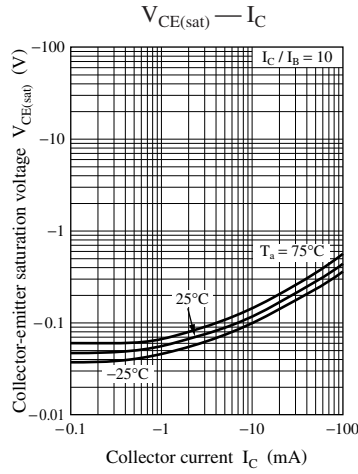
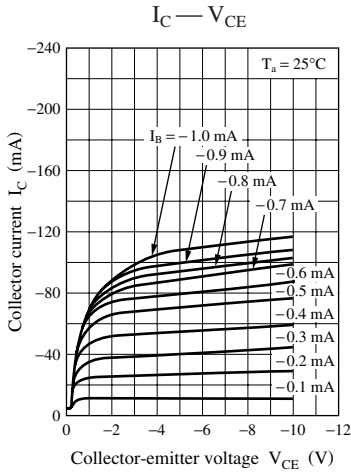

Characteristics charts of UNR4119

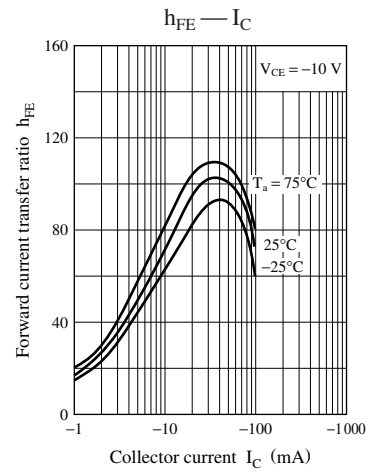
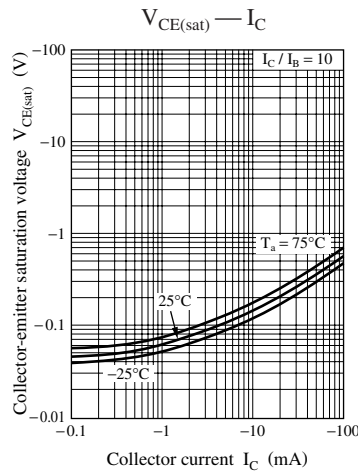
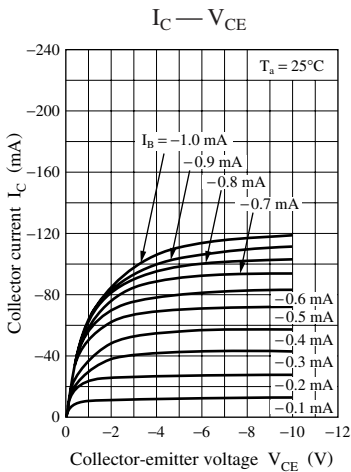

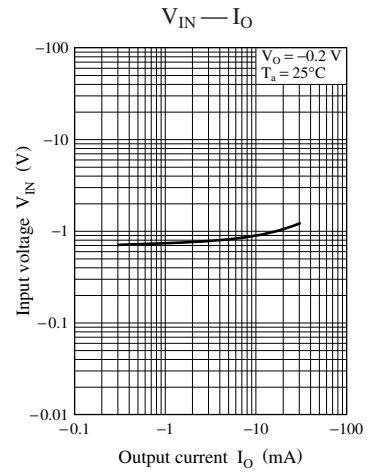
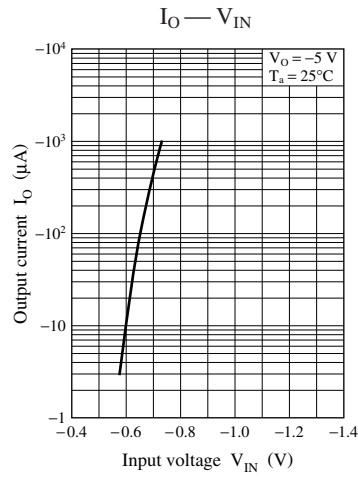
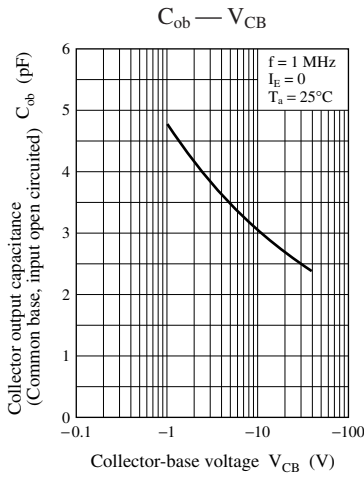

Characteristics charts of UNR411D

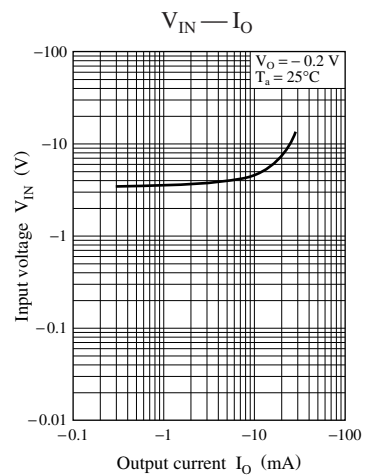
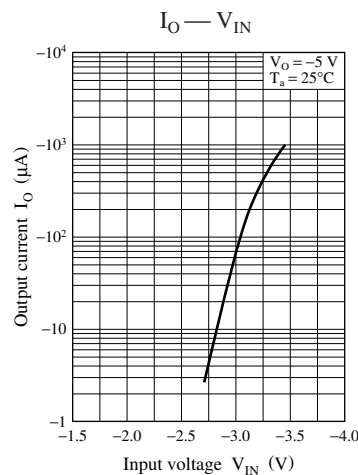
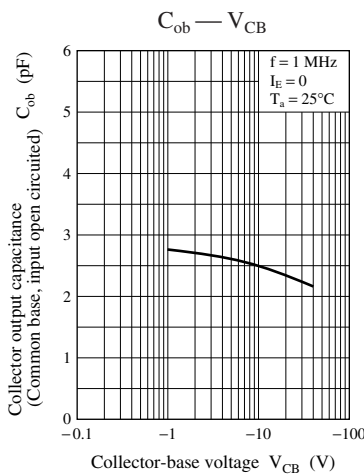
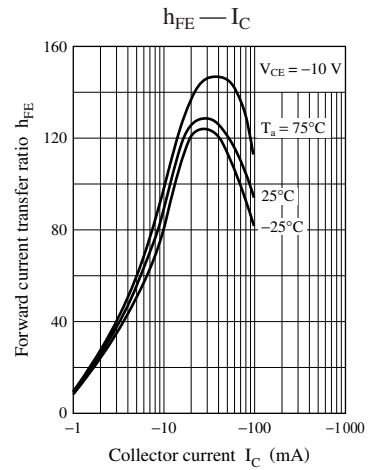
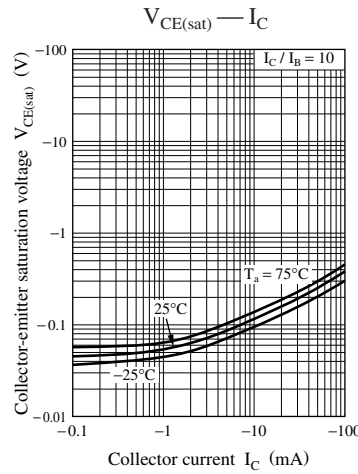
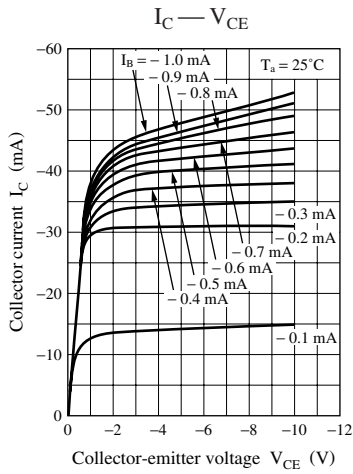

Characteristics charts of UNR411E

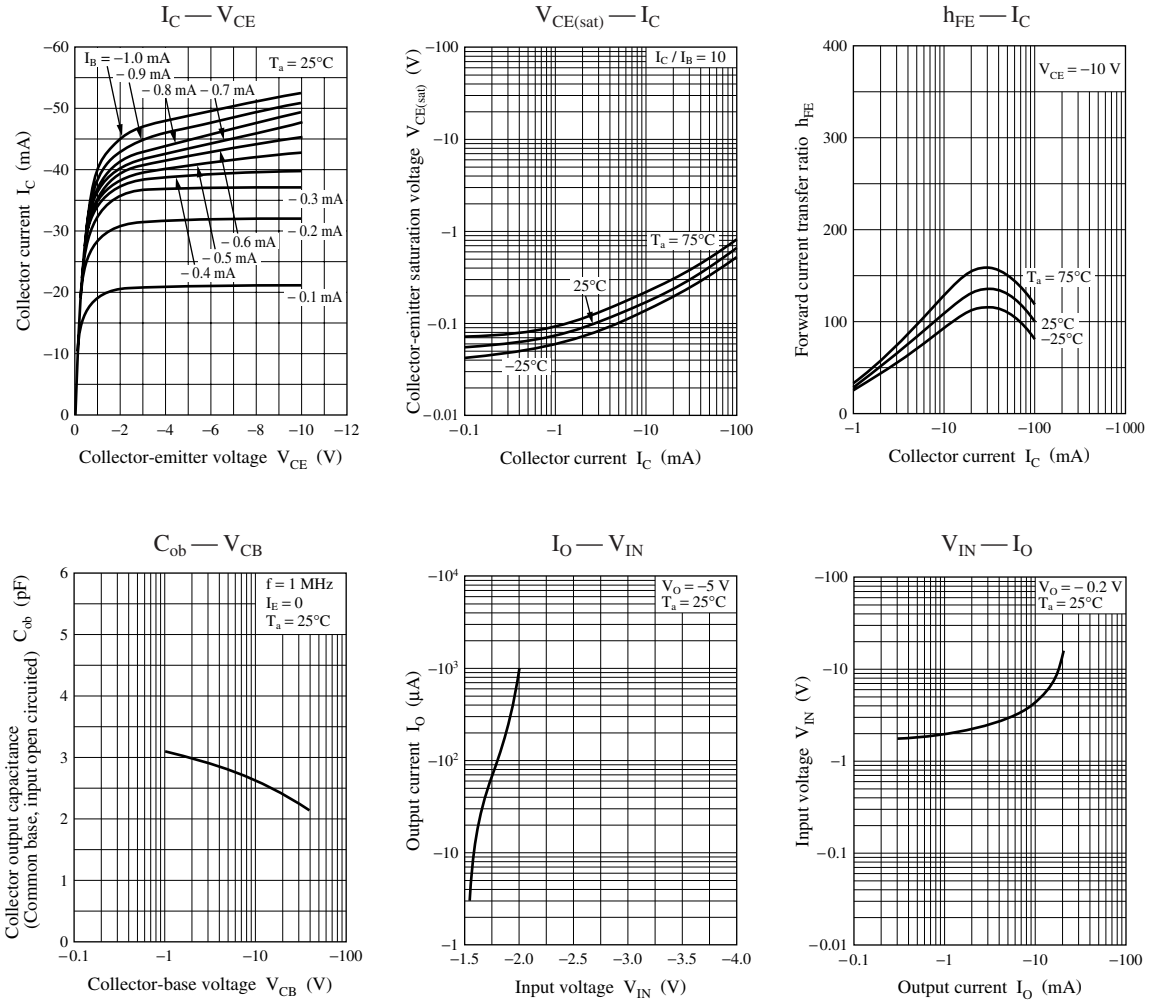

Characteristics charts of UNR411F

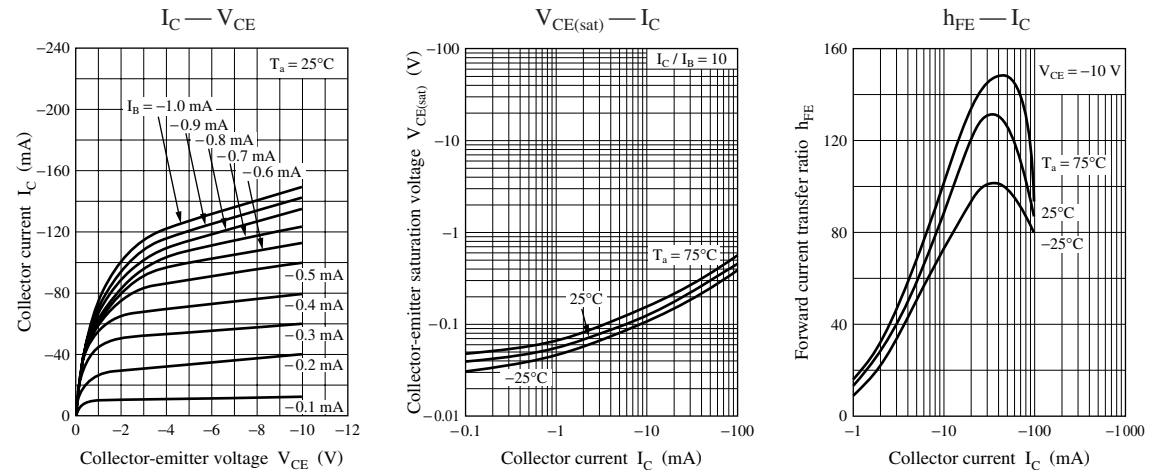

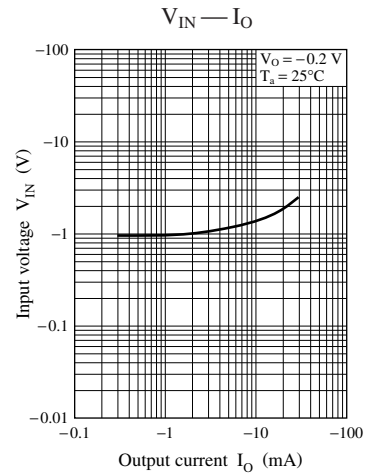
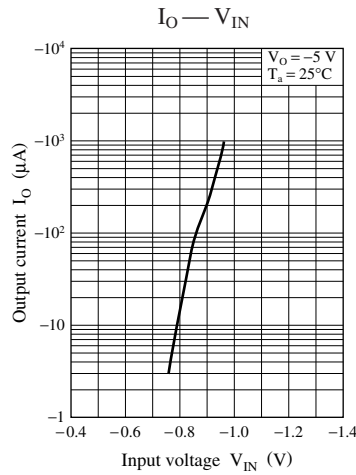
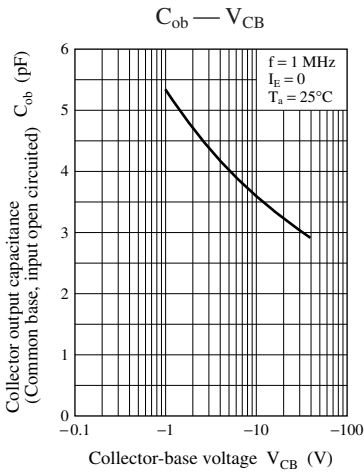

Characteristics charts of UNR411H

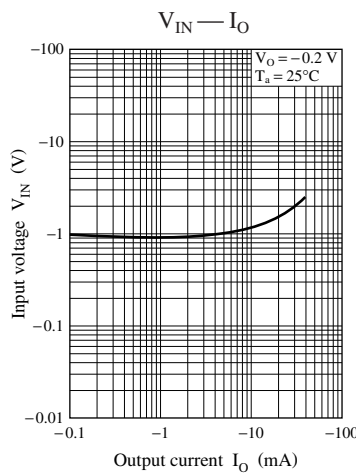
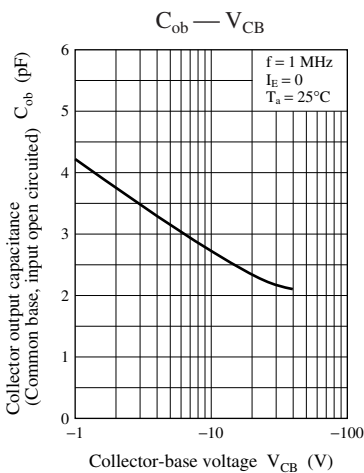
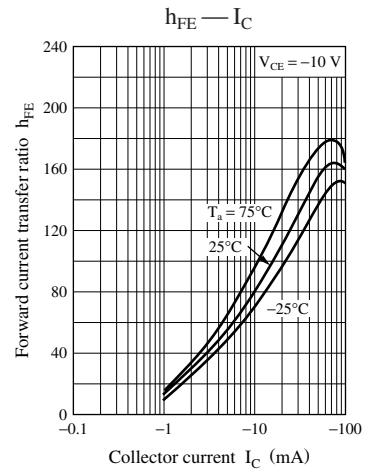
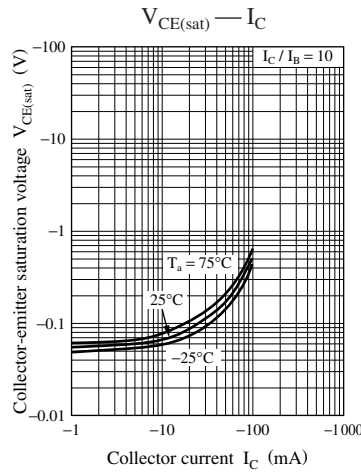
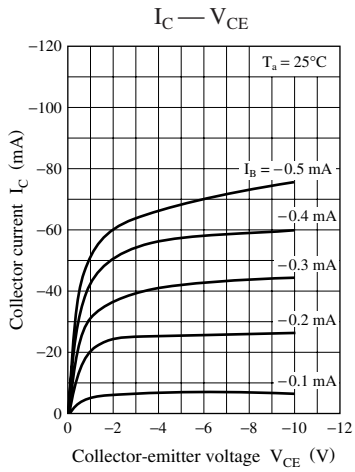

Characteristics charts of UNR411L

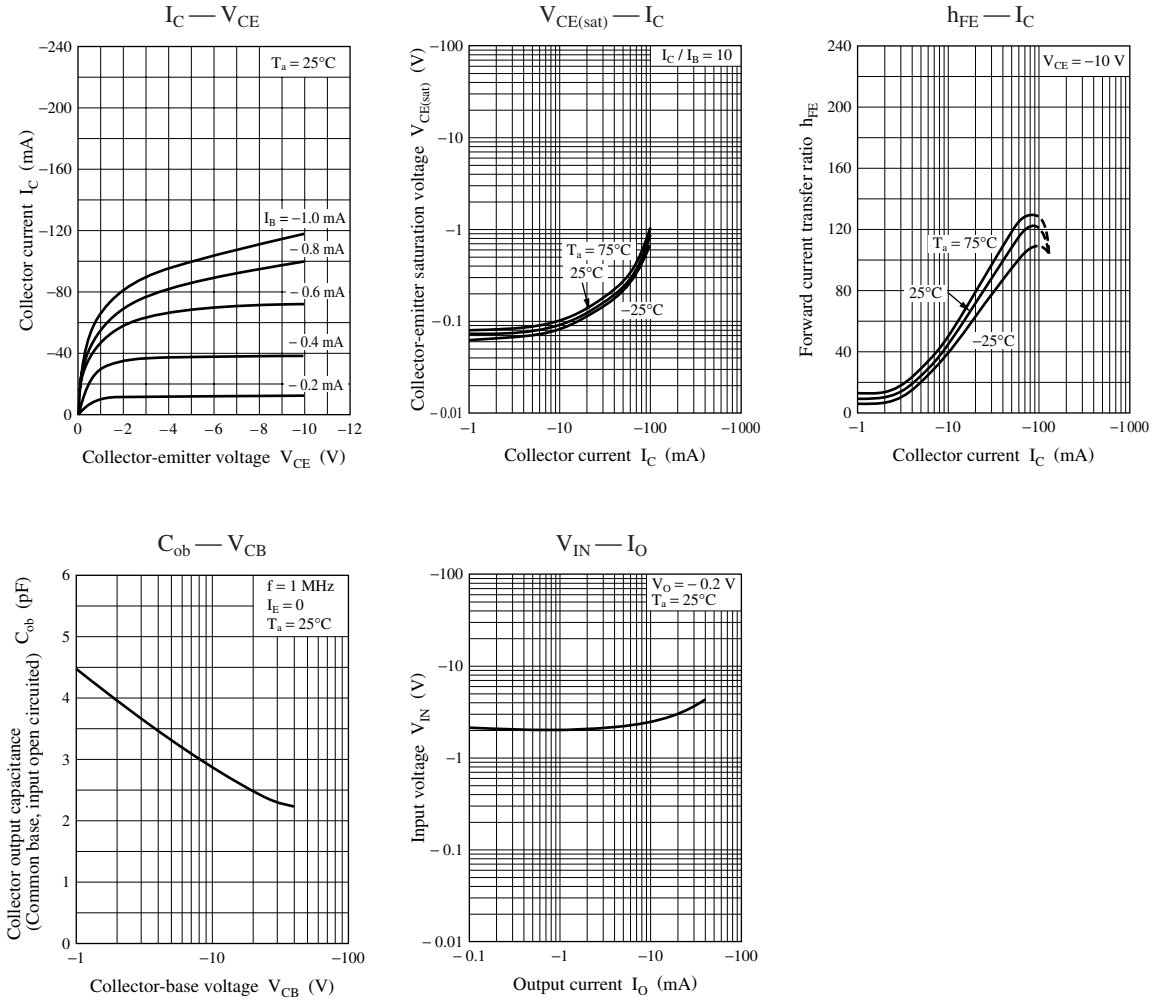

Characteristics charts of UNR411M

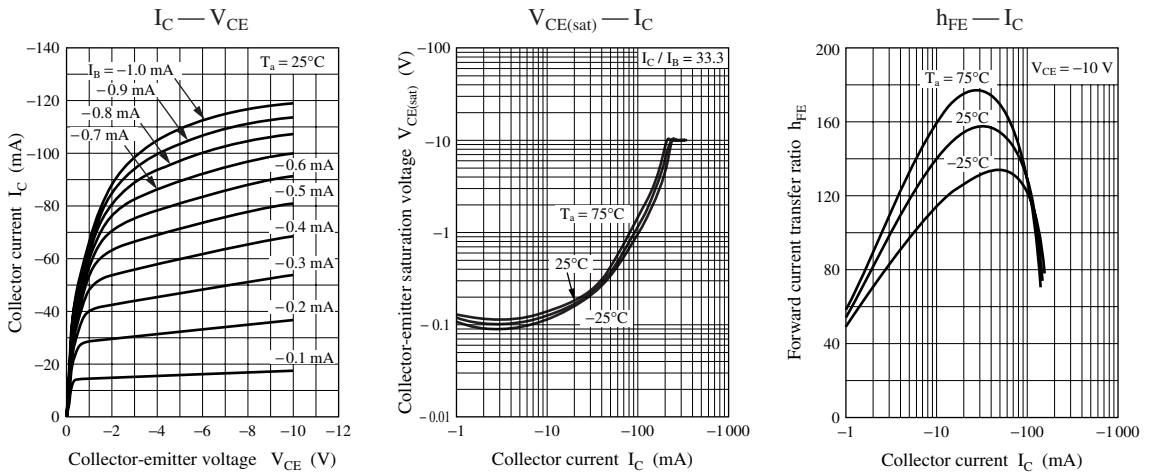

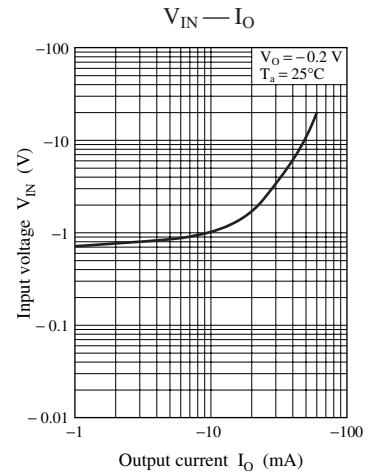
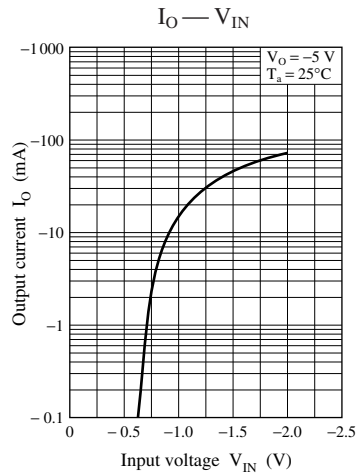
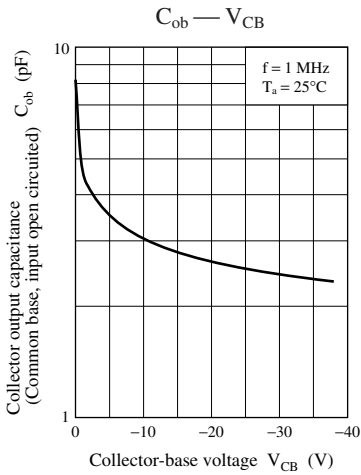

Characteristics charts of UNR411N

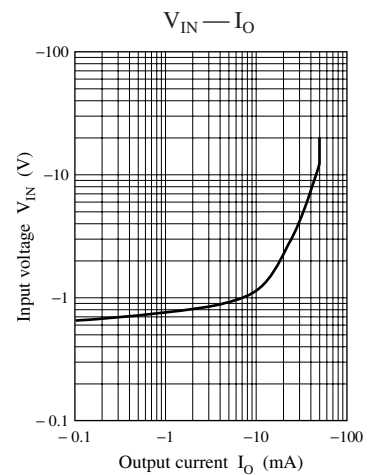
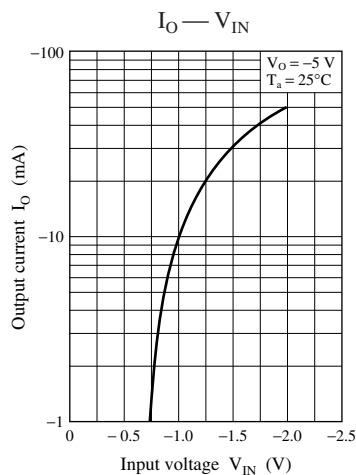
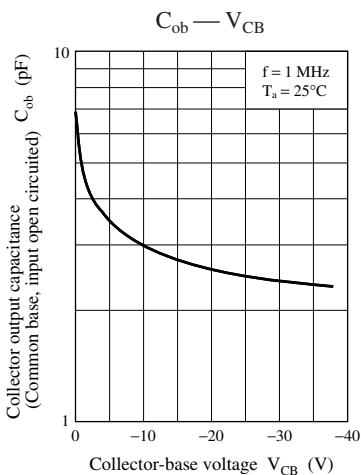
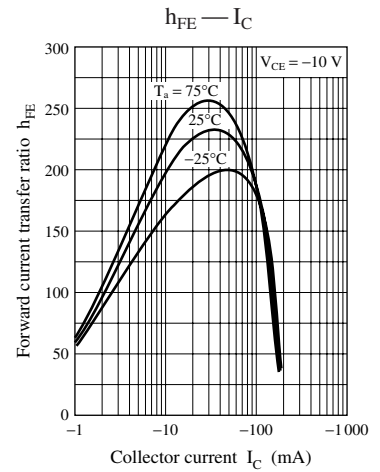
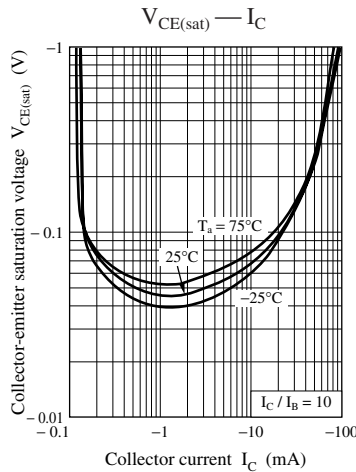
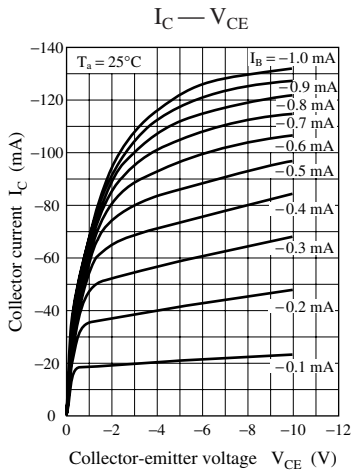

## Request for your special attention and precautions in using the technical information and semiconductors described in this material

- (1) An export permit needs to be obtained from the competent authorities of the Japanese Government if any of the products or technical information described in this material and controlled under the "Foreign Exchange and Foreign Trade Law" is to be exported or taken out of Japan.
- (2) The technical information described in this material is limited to showing representative characteristics and applied circuits examples of the products. It neither warrants non-infringement of intellectual property right or any other rights owned by our company or a third party, nor grants any license.
- (3) We are not liable for the infringement of rights owned by a third party arising out of the use of the technical information as described in this material.
- (4) The products described in this material are intended to be used for standard applications or general electronic equipment (such as office equipment, communications equipment, measuring instruments and household appliances).  
Consult our sales staff in advance for information on the following applications:
  - Special applications (such as for airplanes, aerospace, automobiles, traffic control equipment, combustion equipment, life support systems and safety devices) in which exceptional quality and reliability are required, or if the failure or malfunction of the products may directly jeopardize life or harm the human body.
  - Any applications other than the standard applications intended.
- (5) The products and product specifications described in this material are subject to change without notice for modification and/or improvement. At the final stage of your design, purchasing, or use of the products, therefore, ask for the most up-to-date Product Standards in advance to make sure that the latest specifications satisfy your requirements.
- (6) When designing your equipment, comply with the guaranteed values, in particular those of maximum rating, the range of operating power supply voltage, and heat radiation characteristics. Otherwise, we will not be liable for any defect which may arise later in your equipment.  
Even when the products are used within the guaranteed values, take into the consideration of incidence of break down and failure mode, possible to occur to semiconductor products. Measures on the systems such as redundant design, arresting the spread of fire or preventing glitch are recommended in order to prevent physical injury, fire, social damages, for example, by using the products.
- (7) When using products for which damp-proof packing is required, observe the conditions (including shelf life and amount of time let standing of unsealed items) agreed upon when specification sheets are individually exchanged.
- (8) This material may be not reprinted or reproduced whether wholly or partially, without the prior written permission of Matsushita Electric Industrial Co., Ltd.