

PR29MF11NSZ Series/ PR39MF11NSZ Series

■ Features

1. Compact 8-pin dual-in-line package type
2. RMS ON-state current $I_{T(rms)}$:0.9A
3. Built-in zero-cross circuit
(PR29MF21NSZ/PR39MF21NSZ)
4. High repetitive peak OFF-state voltage
PR29MF11NSZ/PR29MF21NSZ V_{DRM} :MIN. 400V
PR39MF11NSZ/PR39MF21NSZ V_{DRM} :MIN. 600V
5. Isolation voltage between input and output
($V_{iso(rms)}$:4kV)
6. Recognized by UL, file No. E94758
(PR29MF11NSZ/PR39MF11NSZ)
7. Approved by CSA No. LR63705
(PR29MF11NSZ/PR39MF11NSZ)
8. PR29MF21NSZ/PR39MF21NSZ:under preparation
for UL and CSA

■ Applications

1. Various types of home appliances

■ Model Line-up

	For 100V line	For 200V line
No built-in zero-cross circuit	PR29MF11NSZ	PR39MF11NSZ
Built-in zero-cross circuit	PR29MF21NSZ	PR39MF21NSZ

■ Absolute Maximum Ratings (Ta=25°C)

Parameter		Symbol	Rating	Unit	
Input	*1 Forward current	I_F	50	mA	
	Reverse voltage	V_R	6	V	
Output	*1 RMS ON-state current	$I_{T(rms)}$	0.9	A	
	Peak one cycle surge current	I_{surge}	9 (50Hz sine wave)	A	
	Repetitive peak OFF-state voltage	PR29MF11NSZ	V_{DRM}	400	V
		PR29MF21NSZ			
		PR39MF11NSZ		600	
PR39MF21NSZ					
*2 Isolation voltage	$V_{iso(rms)}$	4.0	kV		
Operating temperature	PR29MF11NSZ	T_{opr}	-25 to +85	°C	
	PR39MF11NSZ				
	PR29MF21NSZ		-30 to +85		
	PR39MF21NSZ				
Storage temperature	T_{stg}	-40 to +125	°C		
Soldering temperature	T_{sol}	260 (For 10s)	°C		

*1 The derating factors of absolute maximum ratings due to ambient temperature are shown in Fig. 1, 2

*2 AC for 1 min, 40 to 60%RH, f=60Hz

8-Pin DIP Type SSR for Low Power Control

■ Outline Dimensions

(Unit : mm)

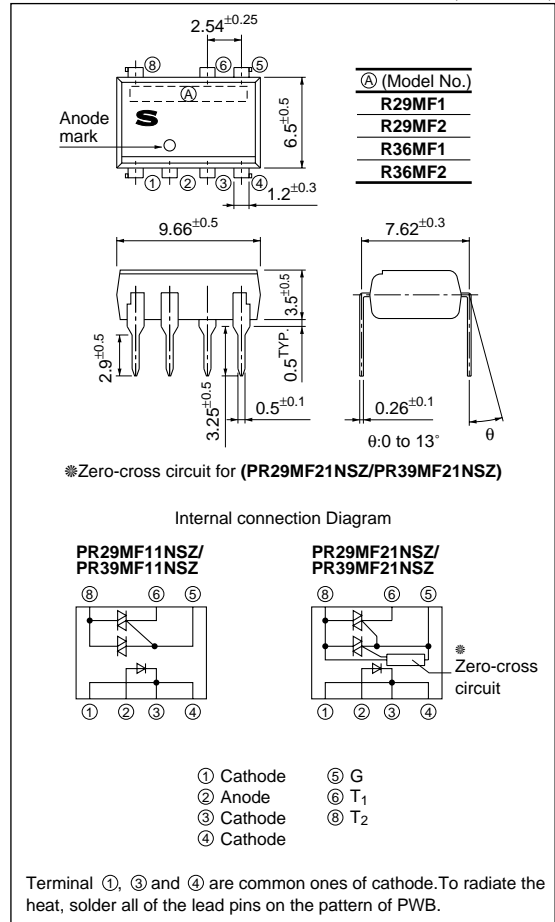

■ Electrical Characteristics

(Ta=25°C)

Parameter		Symbol	Conditions	MIN.	TYP.	MAX.	Unit
Input	Forward voltage	V _F	I _F =20mA	-	1.2	1.4	V
	Reverse current	I _R	V _R =3V	-	-	10	μA
Output	Repetitive peak OFF-state current	I _{DRM}	V _D =V _{DRM}	-	-	100	μA
	ON-state voltage	V _T	I _T =0.9A	-	-	3.0	V
	Holding current	I _H	V _D =6V	-	-	25	mA
	Critical rate of rise of OFF-state voltage	dV/dt	V _D =1/√2 · V _{DRM}	100	-	-	V/μs
	Zero-cross voltage	V _{OX}	I _F =15mA, R load	-	-	35	V
	PR29MF21NSZ PR39MF21NSZ						
Transfer characteristics	Minimum trigger current	I _{FT}	V _D =6V, R _L =100Ω	-	-	10	mA
	Isolation resistance	R _{ISO}	DC=500V, 40 to 60%RH	5×10 ¹⁰	10 ¹¹	-	Ω
	Turn-on time	t _{on}	V _D =6V, R _L =100Ω, I _F =20mA	-	-	100	μs
	PR29MF11NSZ/PR39MF11NSZ PR29MF21NSZ/PR39MF21NSZ					50	

Fig.1 RMS ON-state Current vs. Ambient Temperature (PR29MF11NSZ/PR39MF11NSZ)

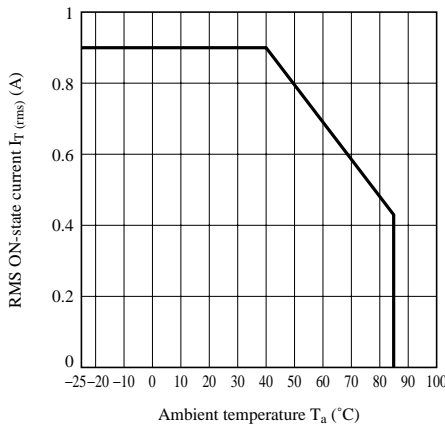

Fig.2 RMS ON-state Current vs. Ambient Temperature (PR29MF21NSZ/PR39MF21NSZ)

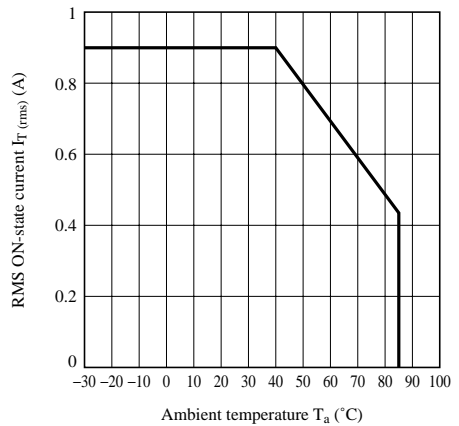

Fig.3 Forward Current vs. Ambient Temperature (PR29MF11NSZ/PR39MF11NSZ)

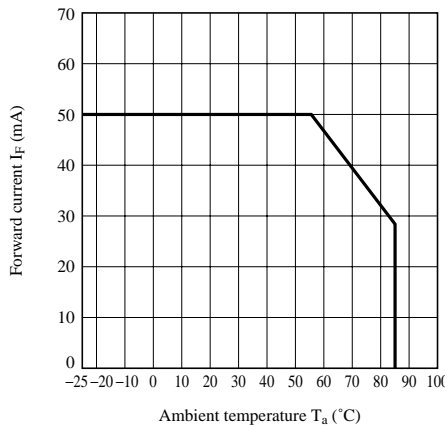

Fig.4 Forward Current vs. Ambient Temperature (PR29MF21NSZ/PR39MF21NSZ)

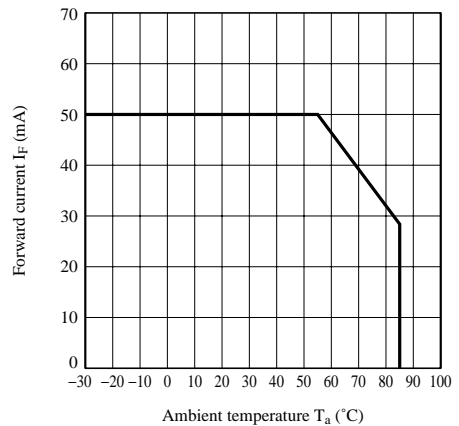

Fig.5 Forward Current vs. Forward Voltage

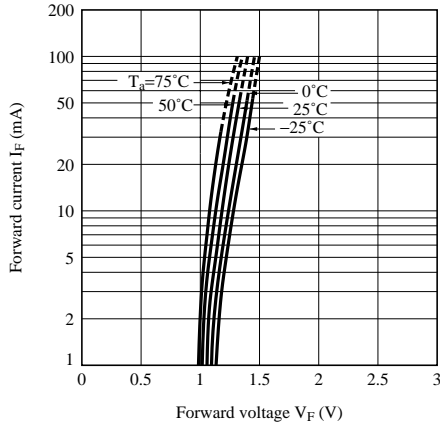

Fig.6 Minimum Trigger Current vs. Ambient Temperature

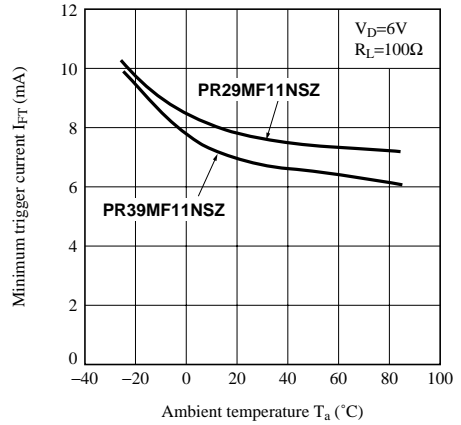

Fig.7 Minimum Trigger Current vs. Ambient Temperature (PR29MF21NSZ/PR39MF21NSZ)

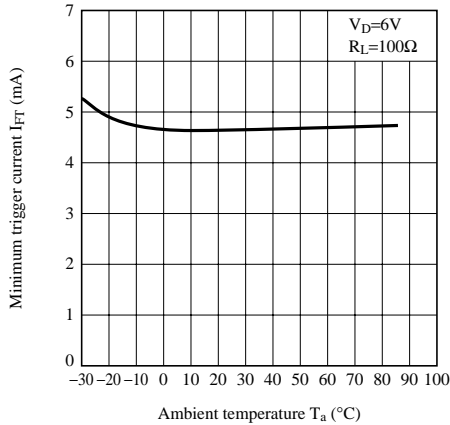

Fig.8 ON-state Voltage vs. Ambient Temperature (PR29MF11NSZ/PR39MF11NSZ)

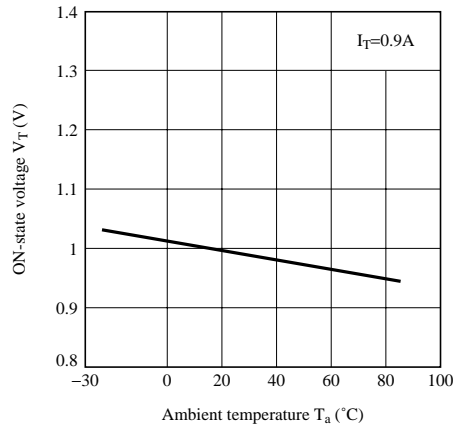

Fig.9 ON-state Voltage vs. Ambient Temperature (PR29MF21NSZ/PR39MF21NSZ)

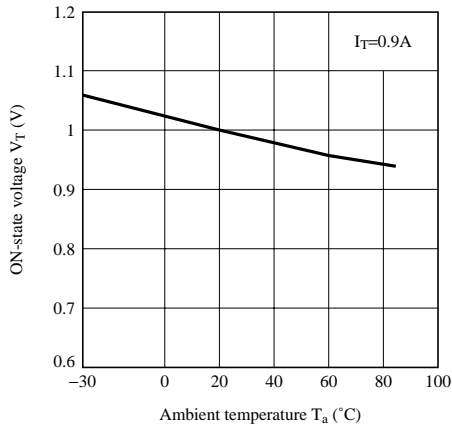

Fig.10 Relative Holding Current vs. Ambient Temperature (PR29MF11NSZ/PR39MF11NSZ)

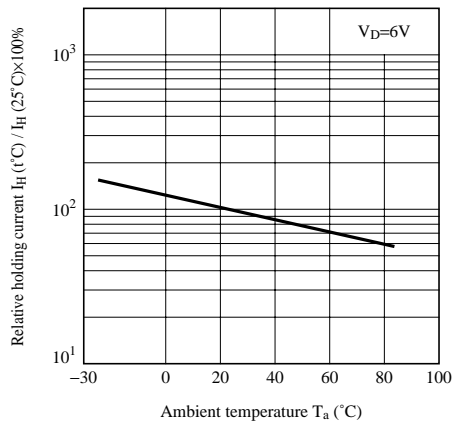

Fig.11 Relative Holding Current vs. Ambient Temperature (PR29MF21NSZ/PR39MF21NSZ)

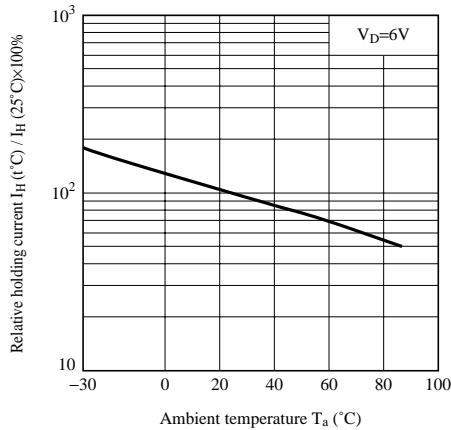

Fig.12 Zero-cross Voltage vs. Ambient Temperature (PR29MF21NSZ/PR39MF21NSZ)

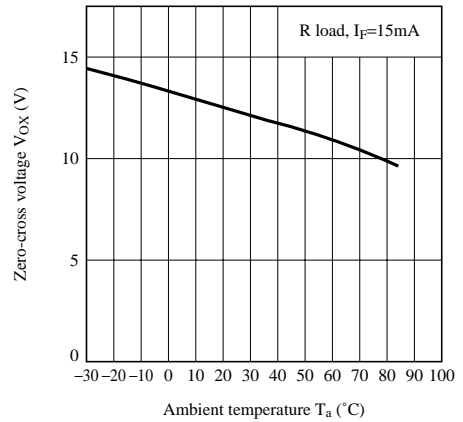

Fig.13 ON-state Current vs. ON-state Voltage (PR29MF11NSZ/PR39MF11NSZ)

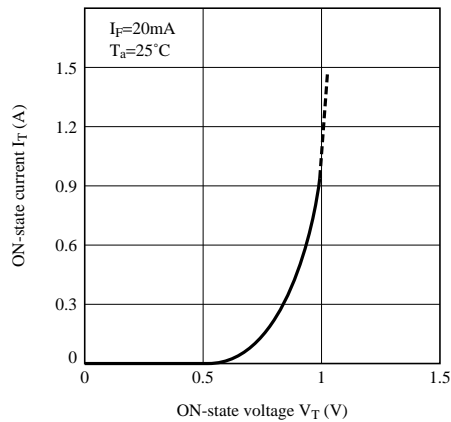

Fig.14 ON-state Current vs. ON-state Voltage (PR29MF21NSZ/PR39MF21NSZ)

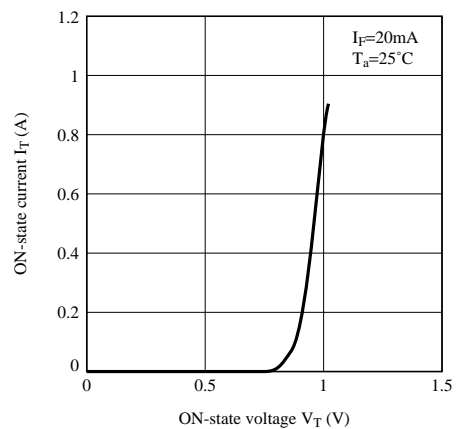

Fig.15 Turn-on Time vs. Forward Current (PR29MF11NSZ)

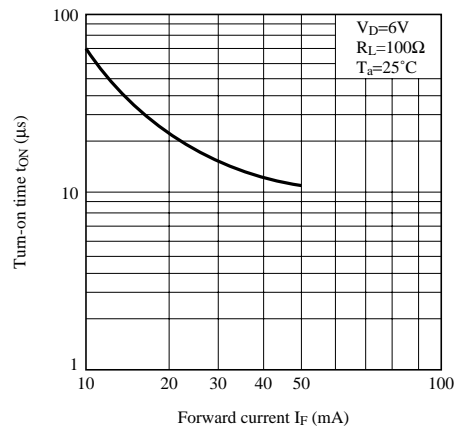

Fig.16 Turn-on Time vs. Forward Current (PR39MF11NSZ)

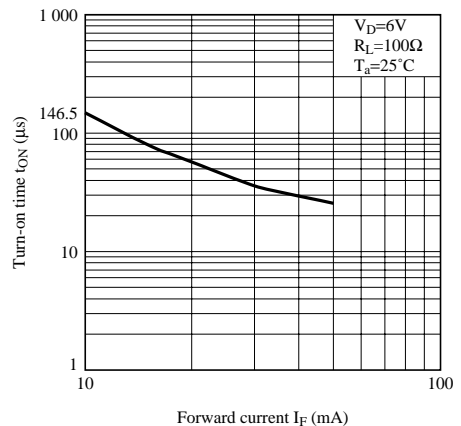
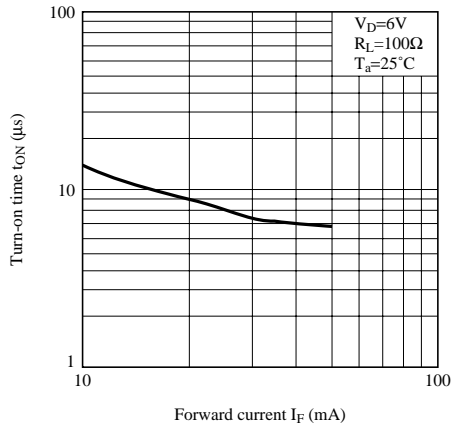

Fig.17 Turn-on Time vs. Forward Current (Typical Value)
(PR29MF21NSZ/PR39MF21NSZ)



NOTICE

- The circuit application examples in this publication are provided to explain representative applications of SHARP devices and are not intended to guarantee any circuit design or license any intellectual property rights. SHARP takes no responsibility for any problems related to any intellectual property right of a third party resulting from the use of SHARP's devices.
- Contact SHARP in order to obtain the latest device specification sheets before using any SHARP device. SHARP reserves the right to make changes in the specifications, characteristics, data, materials, structure, and other contents described herein at any time without notice in order to improve design or reliability. Manufacturing locations are also subject to change without notice.
- Observe the following points when using any devices in this publication. SHARP takes no responsibility for damage caused by improper use of the devices which does not meet the conditions and absolute maximum ratings to be used specified in the relevant specification sheet nor meet the following conditions:
 - (i) The devices in this publication are designed for use in general electronic equipment designs such as:
 - Personal computers
 - Office automation equipment
 - Telecommunication equipment [terminal]
 - Test and measurement equipment
 - Industrial control
 - Audio visual equipment
 - Consumer electronics
 - (ii) Measures such as fail-safe function and redundant design should be taken to ensure reliability and safety when SHARP devices are used for or in connection with equipment that requires higher reliability such as:
 - Transportation control and safety equipment (i.e., aircraft, trains, automobiles, etc.)
 - Traffic signals
 - Gas leakage sensor breakers
 - Alarm equipment
 - Various safety devices, etc.
 - (iii) SHARP devices shall not be used for or in connection with equipment that requires an extremely high level of reliability and safety such as:
 - Space applications
 - Telecommunication equipment [trunk lines]
 - Nuclear power control equipment
 - Medical and other life support equipment (e.g., scuba).
- Contact a SHARP representative in advance when intending to use SHARP devices for any "specific" applications other than those recommended by SHARP or when it is unclear which category mentioned above controls the intended use.
- If the SHARP devices listed in this publication fall within the scope of strategic products described in the Foreign Exchange and Foreign Trade Control Law of Japan, it is necessary to obtain approval to export such SHARP devices.
- This publication is the proprietary product of SHARP and is copyrighted, with all rights reserved. Under the copyright laws, no part of this publication may be reproduced or transmitted in any form or by any means, electronic or mechanical, for any purpose, in whole or in part, without the express written permission of SHARP. Express written permission is also required before any use of this publication may be made by a third party.
- Contact and consult with a SHARP representative if there are any questions about the contents of this publication.