



30CPQ080PbF  
30CPQ100PbF

SCHOTTKY RECTIFIER

30 Amp

$I_{F(AV)} = 30\text{Amp}$   
 $V_R = 80 - 100\text{V}$

**Major Ratings and Characteristics**

Characteristics	Values	Units
$I_{F(AV)}$ Rectangular waveform	30	A
$V_{RRM}$	80-100	V
$I_{FSM}$ @tp = 5 $\mu$ s sine	920	A
$V_F$ @ 15 Apk, $T_J = 125^\circ\text{C}$ (per leg)	0.67	V
$T_J$	-55 to 175	$^\circ\text{C}$

**Description/ Features**

The 30CPQ...PbF center tap Schottky rectifier has been optimized for low reverse leakage at high temperature. The proprietary barrier technology allows for reliable operation up to 175° C junction temperature. Typical applications are in switching power supplies, converters, free-wheeling diodes, and reverse battery protection.

- 175° C  $T_J$  operation
- Center tap TO-247 package
- High purity, high temperature epoxy encapsulation for enhanced mechanical strength and moisture resistance
- Low forward voltage drop
- High frequency operation
- Guard ring for enhanced ruggedness and long term reliability
- Lead-Free ("PbF" suffix)

**Case Styles**

30CPQ...PbF

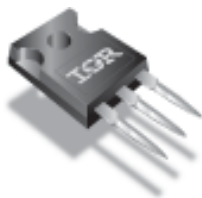

TO-247AC

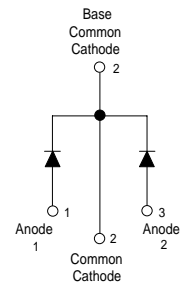

## Voltage Ratings

Part number	30CPQ080PbF	30CPQ100PbF
$V_R$ Max. DC Reverse Voltage (V)	80	100
$V_{RWM}$ Max. Working Peak Reverse Voltage (V)		

## Absolute Maximum Ratings

Parameters	30CPQ...	Units	Conditions
$I_{F(AV)}$ Max. Average Forward Current * See Fig. 5	30	A	50% duty cycle @ $T_C = 140^\circ\text{C}$ , rectangular wave form
$I_{FSM}$ Max. Peak One Cycle Non-Repetitive Surge Current (Per Leg) * See Fig. 7	920	A	Following any rated load condition and with rated $V_{RRM}$ applied
	240		
$E_{AS}$ Non-Repetitive Avalanche Energy (Per Leg)	7.50	mJ	$T_J = 25^\circ\text{C}$ , $I_{AS} = 0.50$ Amps, $L = 60$ mH
$I_{AR}$ Repetitive Avalanche Current (Per Leg)	0.50	A	Current decaying linearly to zero in 1 $\mu\text{sec}$ Frequency limited by $T_{Jmax}$ . $V_A = 1.5 \times V_R$ typical

## Electrical Specifications

Parameters	30CPQ...	Units	Conditions
$V_{FM}$ Max. Forward Voltage Drop (Per Leg) * See Fig. 1 (1)	0.86	V	@ 15A
	1.05	V	@ 30A
	0.67	V	@ 15A
	0.81	V	@ 30A
$I_{RM}$ Max. Reverse Leakage Current (Per Leg) * See Fig. 2 (1)	0.55	mA	$T_J = 25^\circ\text{C}$
	7	mA	$T_J = 125^\circ\text{C}$
$C_T$ Max. Junction Capacitance (Per Leg)	500	pF	$V_R = 5V_{DC}$ , (test signal range 100Khz to 1Mhz) $25^\circ\text{C}$
$L_S$ Typical Series Inductance (Per Leg)	7.5	nH	Measured lead to lead 5mm from package body
dv/dt Max. Voltage Rate of Change	10000	V/ $\mu\text{s}$	(Rated $V_R$ )

(1) Pulse Width < 300 $\mu\text{s}$ , Duty Cycle <2%

## Thermal-Mechanical Specifications

Parameters	30CPQ...	Units	Conditions
$T_J$ Max. Junction Temperature Range	-55 to 175	$^\circ\text{C}$	
$T_{stg}$ Max. Storage Temperature Range	-55 to 175	$^\circ\text{C}$	
$R_{thJC}$ Max. Thermal Resistance Junction to Case (Per Leg)	2.20	$^\circ\text{C}/\text{W}$	DC operation * See Fig. 4
$R_{thJC}$ Max. Thermal Resistance Junction to Case (Per Package)	1.10	$^\circ\text{C}/\text{W}$	DC operation
$R_{thCS}$ Typical Thermal Resistance, Case to Heatsink	0.24	$^\circ\text{C}/\text{W}$	Mounting surface, smooth and greased
wt Approximate Weight	6 (0.21)	g (oz.)	
T Mounting Torque	Min. 6 (5)	Kg-cm (lbf-in)	Non-lubricated threads
	Max. 12 (10)		
Case Style	TO-247AC(TO-3P)	JEDEC	
Device Marking	30CPQ080		
	30CPQ100		

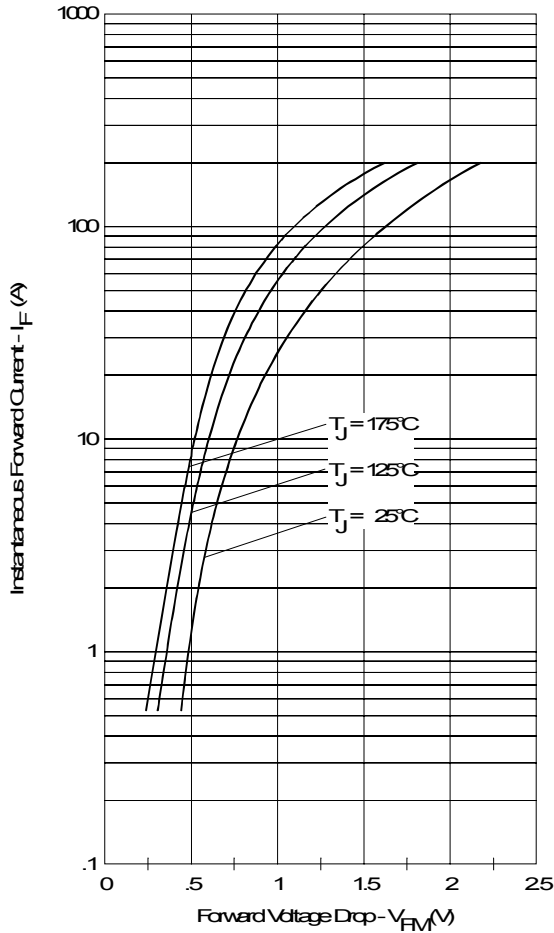

Fig. 1 - Max. Forward Voltage Drop Characteristics (Per Leg)

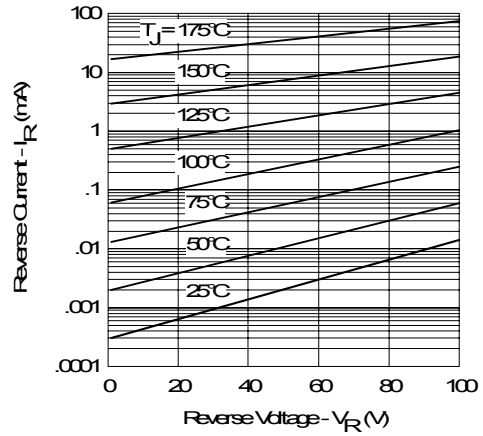

Fig. 2 - Typical Values Of Reverse Current Vs. Reverse Voltage (Per Leg)

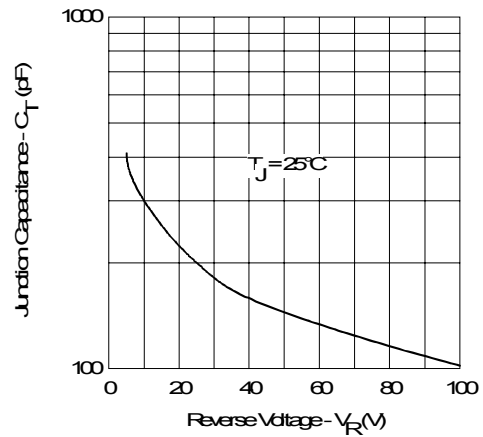

Fig. 3 - Typical Junction Capacitance Vs. Reverse Voltage (Per Leg)

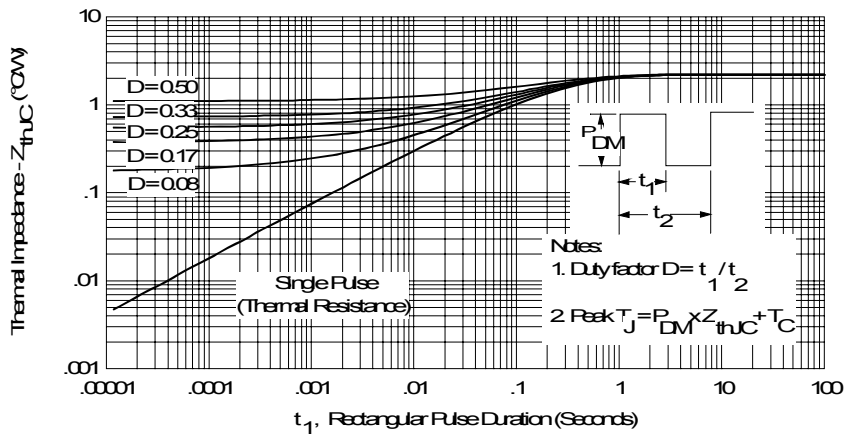

Fig. 4 - Max. Thermal Impedance  $Z_{thJC}$  Characteristics (Per Leg)

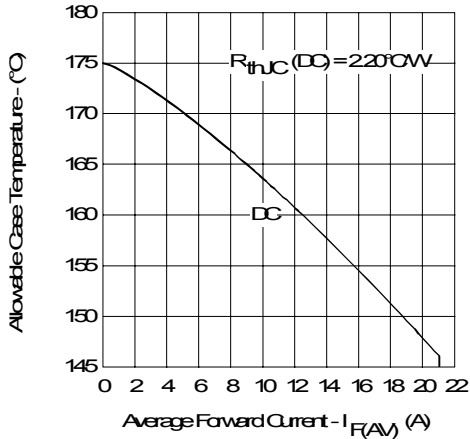

Fig. 5 - Max. Allowable Case Temperature Vs. Average Forward Current (Per Leg)

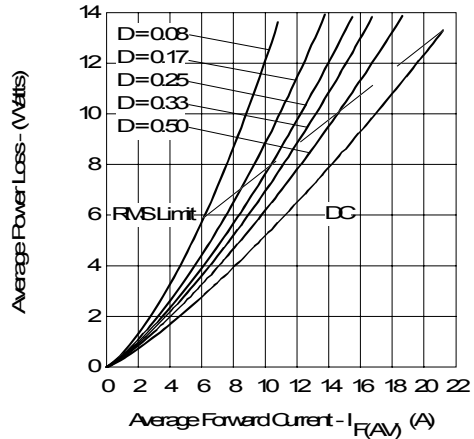

Fig. 6 - Forward Power Loss Characteristics (Per Leg)

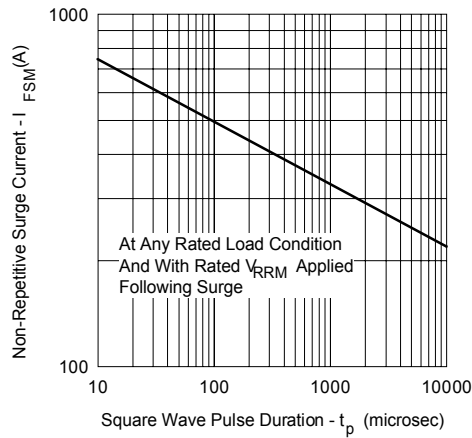

Fig. 7 - Max. Non-Repetitive Surge Current (Per Leg)

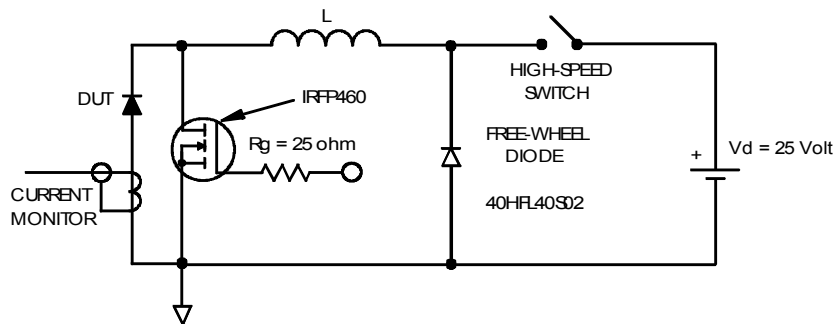
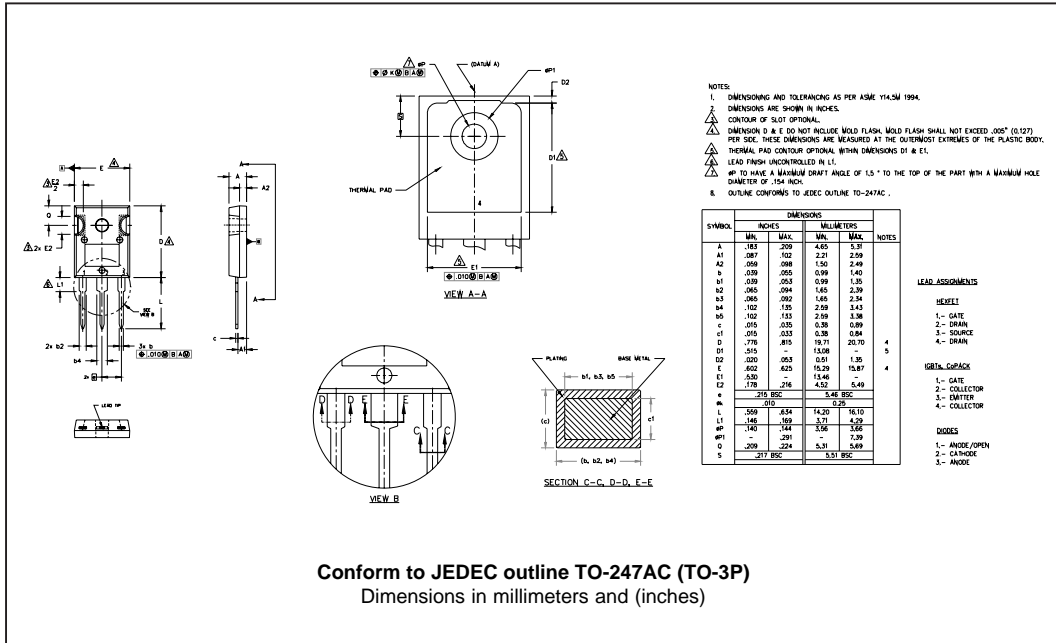
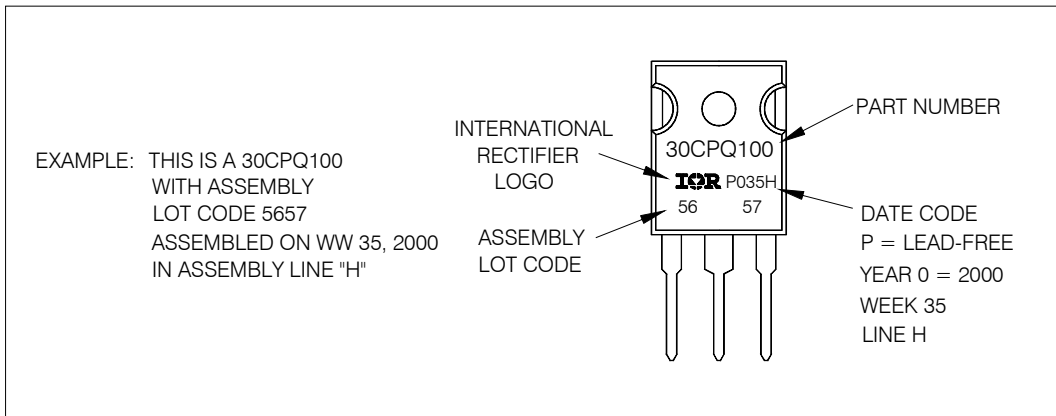

Fig. 8 - Unclamped Inductive Test Circuit

Outline Table



Marking Information



Ordering Information Table

Device Code					
30	C	P	Q	100	PbF
①	②	③	④	⑤	⑥
<b>1</b>	-	Current Rating			
<b>2</b>	-	Circuit Configuration			
		C = Common Cathode			
<b>3</b>	-	Package			
		P = TO-247			
<b>4</b>	-	Schottky "Q" Series			
<b>5</b>	-	Voltage Code			
<b>6</b>	-	• none = Standard Production			
		• PbF = Lead-Free			
			080 = 80V		
			100 = 100V		
Tube Standard Pack Quantity : 25 pieces					

Data and specifications subject to change without notice.  
This product has been designed and qualified for Industrial Level and Lead-Free.  
Qualification Standards can be found on IR's Web site.