



ULN2004

LINEAR INTEGRATED CIRCUIT

7CH DARLINGTON SINK DRIVER

DESCRIPTION

The UTC **ULN2004** are high-voltage, high-current darlington drivers comprised of seven NPN darlington pairs.

All units feature integral clamp diodes for switching inductive loads.

Applications include relay, hammer, lamp and display (LED) drivers.

FEATURES

*Output current (single output): 500mA (MAX.)

*High sustaining voltage output: 50V (MIN.)

*Output clamp diodes

*Inputs compatible with various types of logic

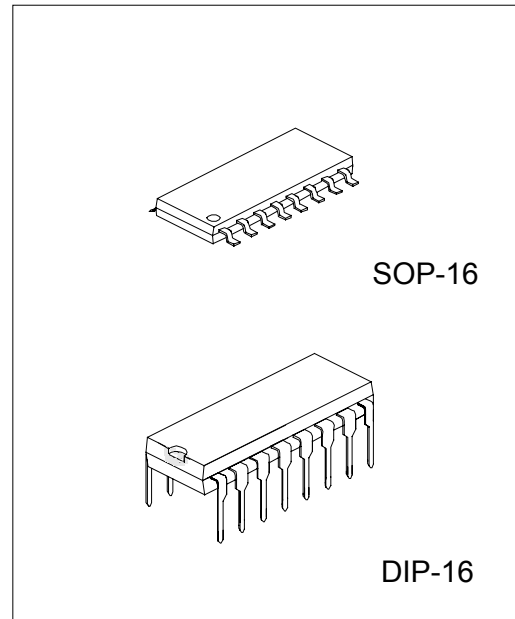

*Pb-free plating product number: ULN2004L

ORDERING INFORMATION

Order Number		Package	Packing
Normal	Lead free plating		
ULN2004-S16-R	ULN2004L-S16-R	SOP-16	Tape Reel
ULN2004-S16-T	ULN2004L-S16-T	SOP-16	Tube
ULN2004-D16-T	ULN2004L-D16-T	DIP-16	Tube

■ PIN CONNECTION

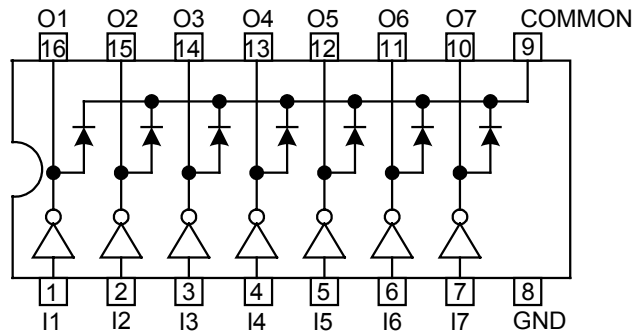

■ BLOCK DIAGRAM

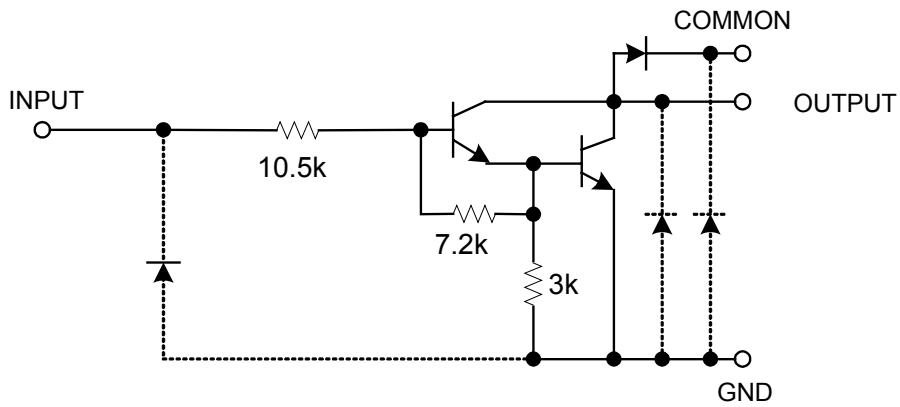

Note: The input and output parasitic diodes cannot be used as clamp diodes.

■ ABSOLUTE MAXIMUM RATINGS (Ta=25°C)

PARAMETER	SYMBOL	RATING	UNIT
Output Sustaining Voltage	V _{OUT}	-0.5~50	V
Output Current	I _{OUT}	500	mA / ch
Input Voltage	V _{IN}	-0.5~30	V
Clamp Diode Reverse Voltage	V _R	50	V
Clamp Diode Forward Current	I _F	500	mA
Power Dissipation	DIP-16	P _D	1.47
	SOP-16		0.625
Junction Temperature	T _J	+125	
Operating Temperature	T _{OPR}	0~+70	
Storage Temperature	T _{STG}	-40~+150	

Note 1. Absolute maximum ratings are those values beyond which the device could be permanently damaged. Absolute maximum ratings are stress ratings only and functional device operation is not implied.

2. The device is guaranteed to meet performance specification within 0 ~+70 operating temperature range and assured by design from -20 ~+85 .

■ RECOMMENDED OPERATING CONDITIONS (Ta=-40~+85)

CHARACTERISTIC	SYMBOL	TEST CONDITIONS	MIN	TYP	MAX	UNIT
Output Sustaining Voltage	V _{OUT}		0		50	V
Output Current	I _{OUT}	T _{pw} = 25ms 7 Circuits Ta = 85 TJ = 120	Duty = 10%	0	370	mA/ch
			Duty = 50%	0	130	
			Duty = 10%	0	233	
			Duty = 50%	0	70	
Input Voltage	V _{IN}		0		24	V
Input Voltage (Output On)	V _{IN(ON)}	I _{OUT} = 400mA, h _{FE} = 800	6.2		24	V
Input Voltage (Output Off)	V _{IN(OFF)}		0		1.0	V
Clamp Diode Reverse Voltage	V _R				50	V
Clamp Diode Forward Current	I _F				350	mA
Power Dissipation	DIP-16	P _D	Ta = 85		0.76	W
	SOP-16		Ta = 85		0.325	

■ ELECTRICAL CHARACTERISTICS (Ta=25 unless otherwise specified)

CHARACTERISTIC	SYMBOL	TEST CIRCUIT	TEST CONDITIONS	MIN	TYP	MAX	UNIT
Output Leakage Current	I _{LEAK}	1	V _{CE} = 50 V, Ta = 25			50	μA
			V _{CE} = 50 V, Ta = 85			100	
Collector-Emitter Saturation Voltage	V _{CEO(SAT)}	2	I _{OUT} = 350 mA, I _{IN} = 500 μA		1.3	1.6	V
			I _{OUT} = 200 mA, I _{IN} = 350 μA		1.1	1.3	
			I _{OUT} = 100 mA, I _{IN} = 250 μA		0.9	1.1	
DC Current Transfer Ratio	h _{FE}	2	V _{CE} = 2 V, I _{OUT} = 350 mA	1000			
Input Current (Output On)	I _{IN(ON)}	3	V _{IN} = 9.5 V, I _{OUT} = 350 mA		0.8	1.2	mA
Input Current (Output Off)	I _{IN(OFF)}	4	I _{OUT} = 500 μA, Ta = 85°C	50	65		μA
Input Voltage (Output On)	V _{IN(ON)}	5	V _{CE} = 2 V, I _{OUT} = 350 mA			4.7	V
			h _{FE} = 800, I _{OUT} = 200 mA			4.4	
Clamp Diode Reverse Current	I _R	6	V _R = 50 V, Ta = 25°C			50	μA
			V _R = 50 V, Ta = 85°C			100	
Clamp Diode Forward Voltage	V _F	7	I _F = 350 mA			2.0	V
Input Capacitance	C _{IN}				15		pF
Turn-On Delay	t _{ON}	8	V _{OUT} = 50 V, R _L = 125 Ω C _L = 15 pF		0.1		μs
Turn-Off Delay	t _{OFF}	8	V _{OUT} = 50 V, R _L = 125 Ω C _L = 15 pF		0.2		

■ TEST CIRCUIT

1. I_{LEAK}

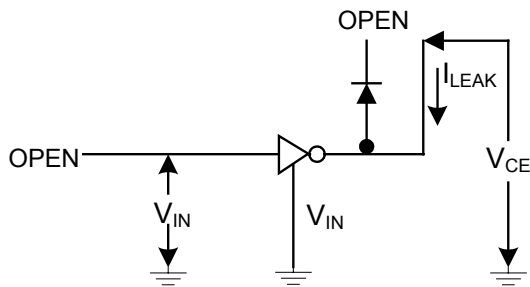

2. $V_{CEO(SAT)}, h_{FE}$

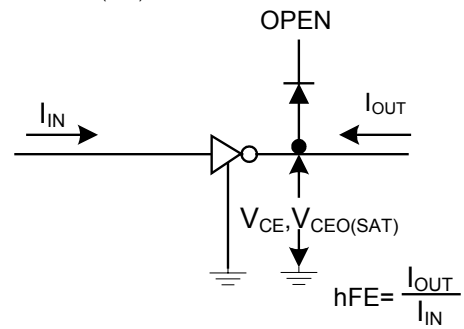

3. $I_{IN(ON)}$

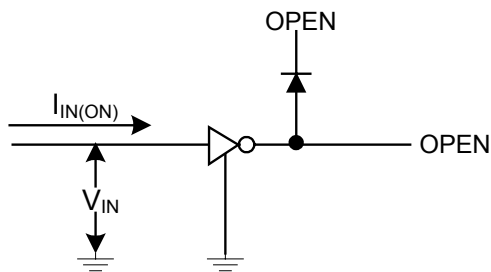

4. $I_{IN(OFF)}$

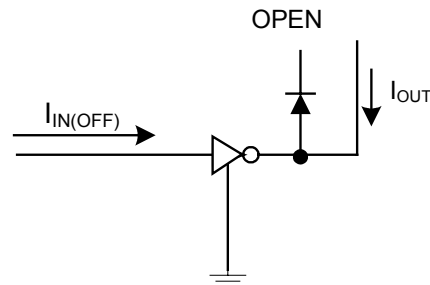

5. $V_{IN(ON)}$

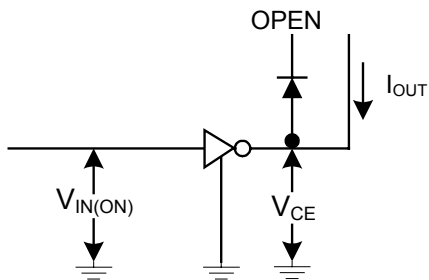

6. I_R

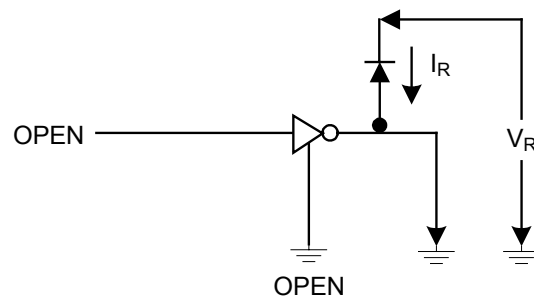

■ TEST CIRCUIT(cont.)

7. V_F

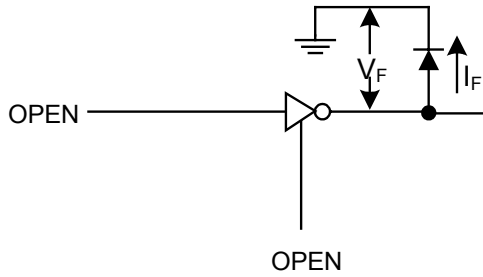

8. t_{ON} , t_{OFF}

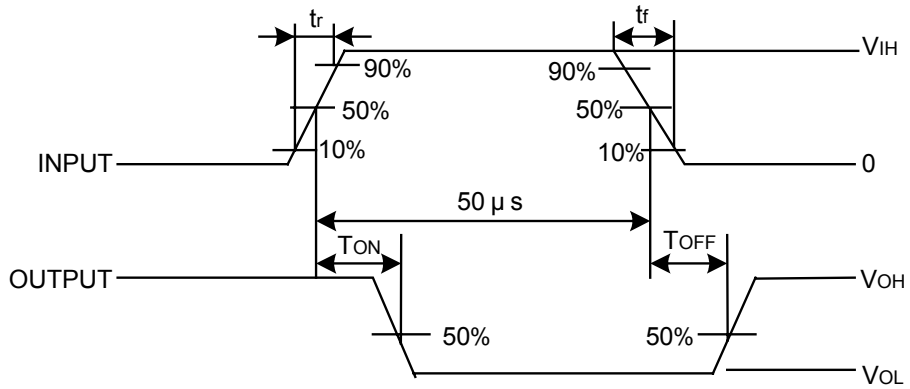
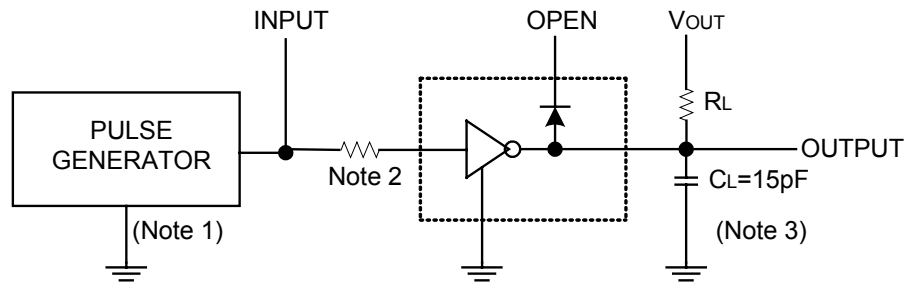

Note1: Pulse width $50 \mu s$, duty cycle 10%
Output impedance 50Ω , t_r 5ns, t_f 10ns

Note2: See below

INPUT CONDITION

TYPE NUMBER	R1	V_{IH}
ULN2004	0	8V

Note3: C_L includes probe and jig capacitance

■ PRECAUTIONS FOR USING

This IC does not include built-in protection circuits for excess current or overvoltage. If this IC is subjected to excess current or overvoltage, it may be destroyed. Hence, the utmost care must be taken when systems which incorporate this IC are designed. Utmost care is necessary in the design of the output line, COMMON and GND line since IC may be destroyed due to short-circuit between outputs, air contamination fault, or fault by improper grounding.

■ TYPICAL CHARACTERISTICS

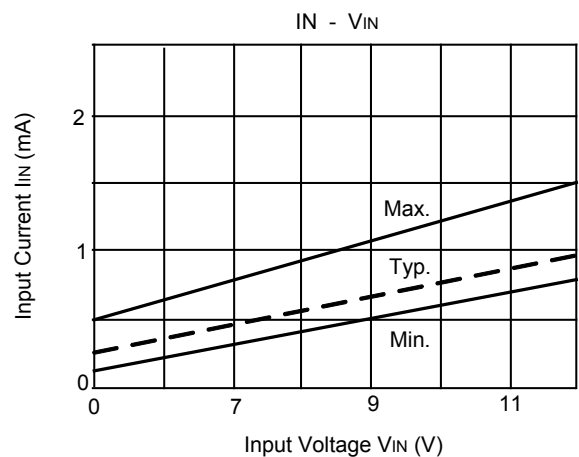
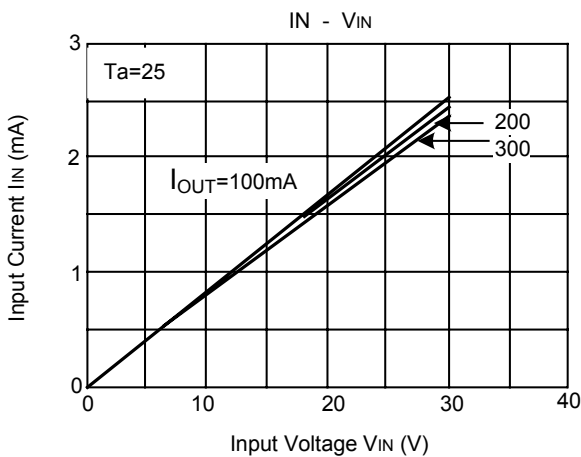
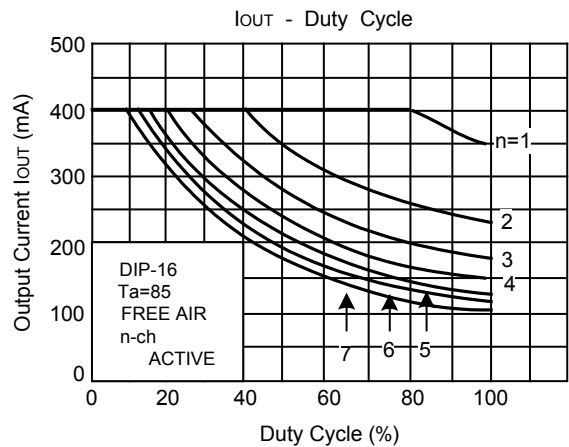
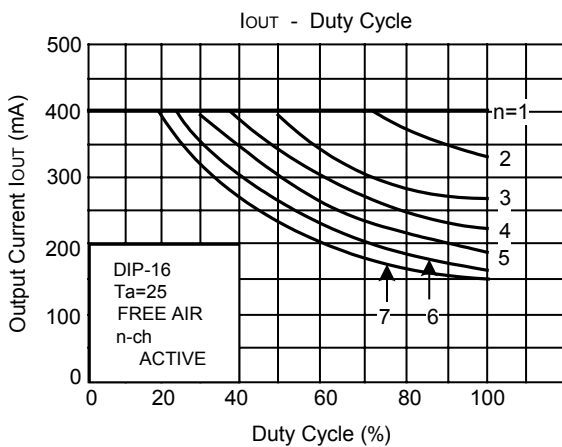
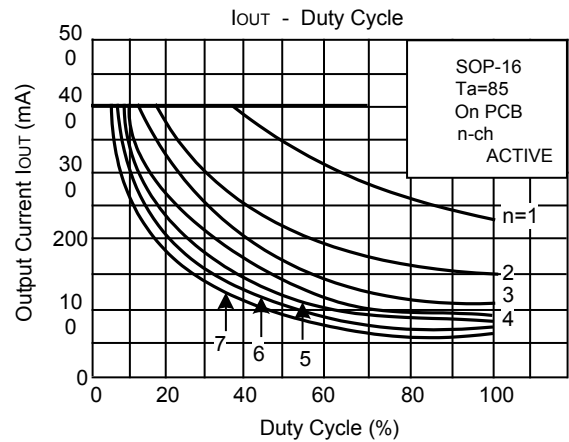
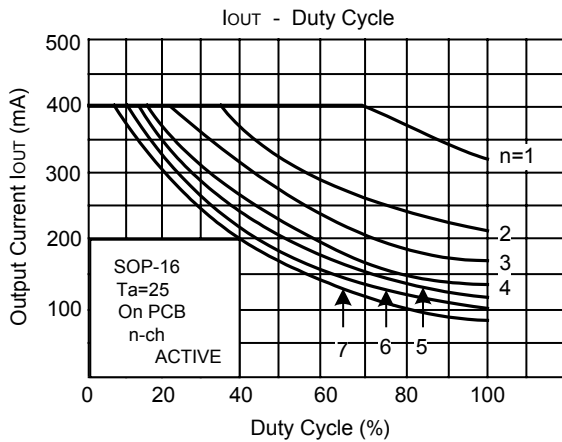

■ TYPICAL CHARACTERISTICS(cont.)

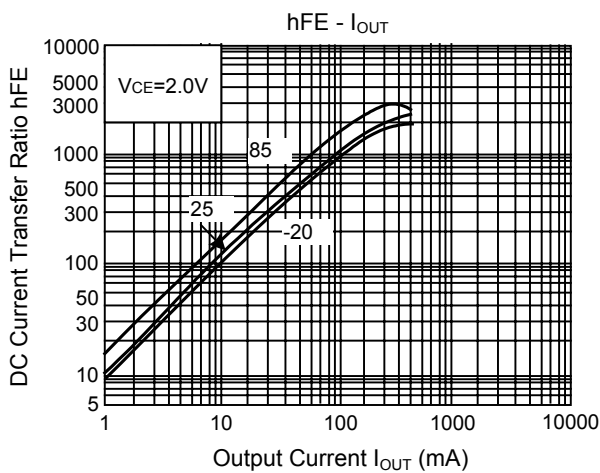
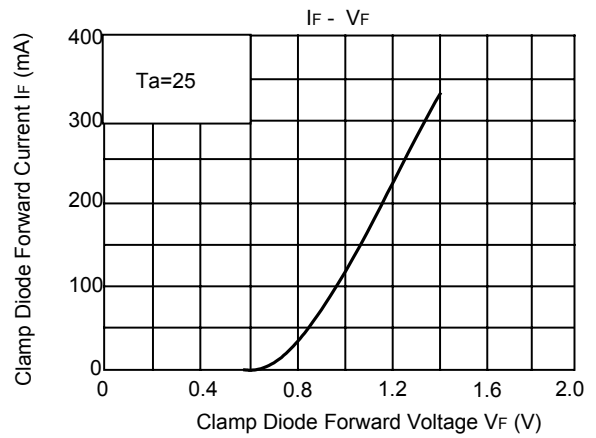
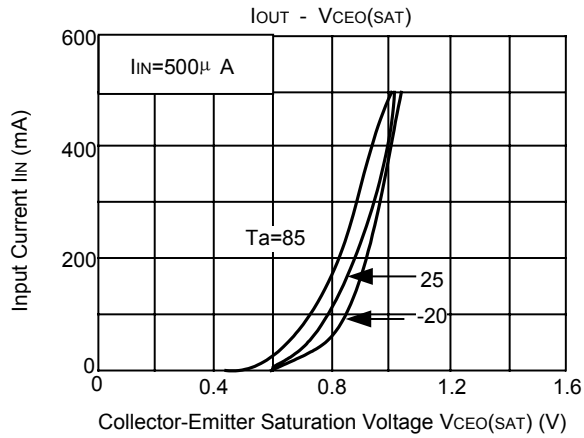
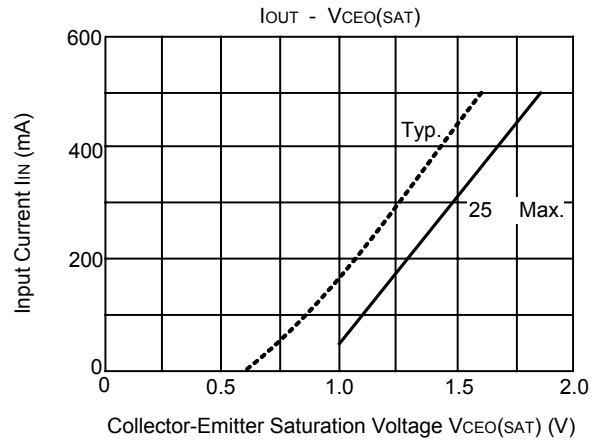
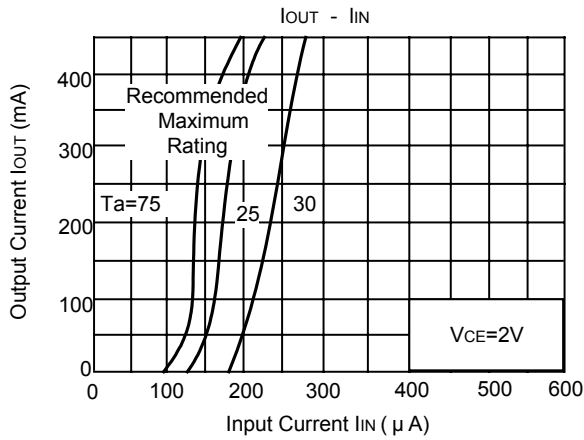

■ TYPICAL CHARACTERISTICS(cont.)

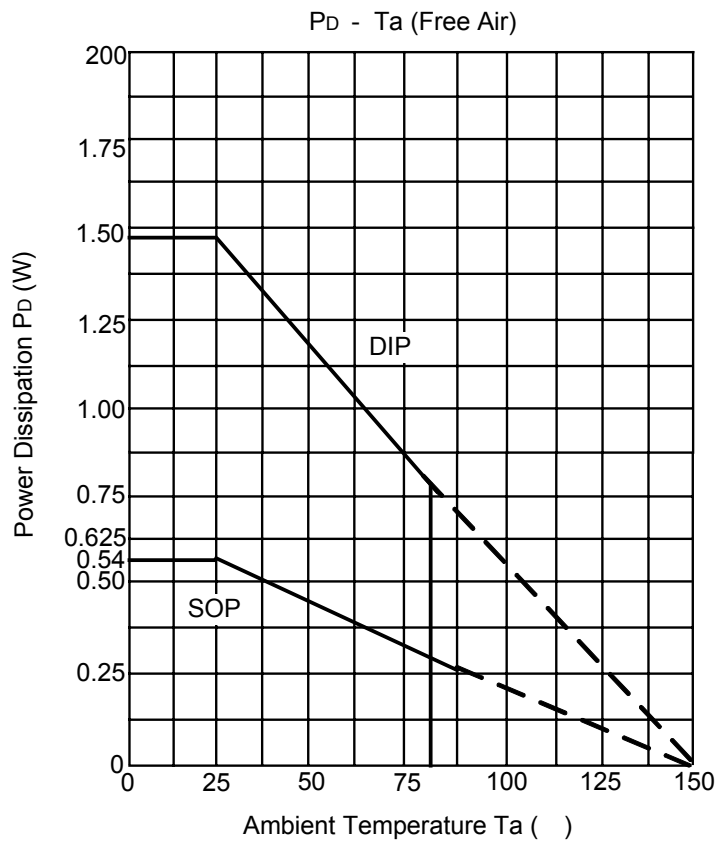

UTC assumes no responsibility for equipment failures that result from using products at values that exceed, even momentarily, rated values (such as maximum ratings, operating condition ranges, or other parameters) listed in products specifications of any and all UTC products described or contained herein. UTC products are not designed for use in life support appliances, devices or systems where malfunction of these products can be reasonably expected to result in personal injury. Reproduction in whole or in part is prohibited without the prior written consent of the copyright owner. The information presented in this document does not form part of any quotation or contract, is believed to be accurate and reliable and may be changed without notice.