

Product Description

Sirenza Microdevices' SXT-289 amplifier is a high efficiency GaAs Heterojunction Bipolar Transistor (HBT) MMIC housed in low-cost surface-mountable plastic package. These HBT MMICs are fabricated using molecular beam epitaxial growth technology which produces reliable and consistent performance from wafer to wafer and lot to lot.

These amplifiers are specially designed for use as driver devices for infrastructure equipment in the 1800-2500 MHz cellular, ISM, WLL and Wideband CDMA applications.

Its high linearity makes it an ideal choice for multi-carrier as well as digital applications.

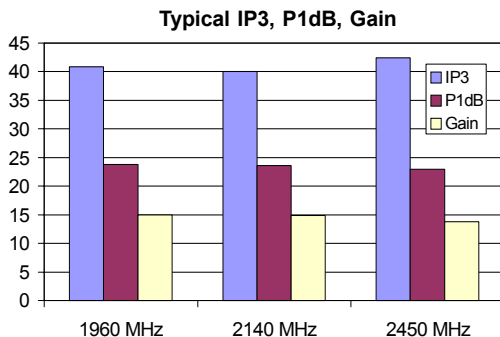

SXT-289

1800-2500 MHz Medium Power GaAs HBT Amplifier



Product Features

- Patented High Reliability GaAs HBT Technology
- High Output 3rd Order Intercept : +42 dBm typ. at 2450 MHz
- Surface-Mountable Power Plastic Package

Applications

- Balanced Amplifier Configuration App. Note (AN-011)
- PCS Systems
- WLL, Wideband CDMA Systems
- ISM Systems

Symbol	Parameters: Test Conditions: $Z_0 = 50 \text{ Ohms}$, $T_a = 25^\circ\text{C}$		Units	Min.	Typ.	Max.
P_{1dB}	Output Power at 1dB Compression	f = 1960 MHz f = 2140 MHz f = 2450 MHz	dBm dBm dBm	22.5	23.5 23.5 23.0	
S_{21}	Small signal gain	f = 1960 MHz f = 2140 MHz f = 2450 MHz	dB dB dB	13.5	15.0 15.0 13.8	16.6
S_{11}	Input VSWR	f = 1960 MHz f = 2140 MHz f = 2450 MHz	-		1.4:1 1.6:1 1.6:1	
IP_3	Output Third Order Intercept Point (P _{out} /Tone = +11 dBm, Tone spacing = 1 MHz)	f = 1960 MHz f = 2140 MHz f = 2450 MHz	dBm dBm dBm	37.5	41.0 40.0 42.0	
NF	Noise Figure	f = 1960 MHz f = 2140 MHz f = 2450 MHz	dB dB dB		4.4 4.5 5.4	
I_D	Device Current	$V_S = 8\text{V}$ $R_{BAS} = 27 \text{ Ohms}$ $V_D = 5 \text{ V typ.}$	mA	85	105	120
$R_{th(j-l)}$	Thermal Resistance (junction - lead)		$^\circ\text{C/W}$		108	

The information provided herein is believed to be reliable at press time. Sirenza Microdevices assumes no responsibility for inaccuracies or omissions. Sirenza Microdevices assumes no responsibility for the use of this information, and all such information shall be entirely at the user's own risk. Prices and specifications are subject to change without notice. No patent rights or licenses to any of the circuits described herein are implied or granted to any third party. Sirenza Microdevices does not authorize or warrant any Sirenza Microdevices product for use in life-support devices and/or systems. Copyright 2001 Sirenza Microdevices, Inc. All worldwide rights reserved.

SXT-289 1800-2500 MHz Power Amplifier

1960 MHz Application Circuit Data, $V_s=8V$, $I_D=105mA$, $R_{BIAS}=27\ \Omega$

Note: Tuned for Output IP3

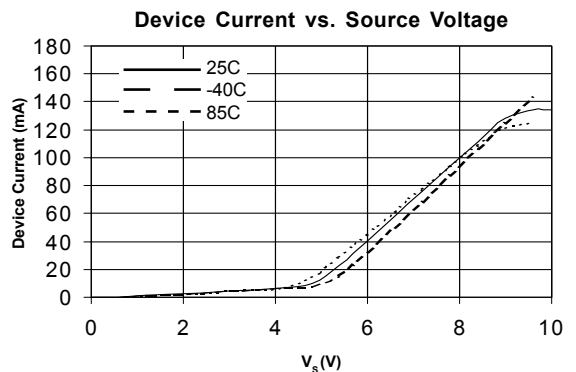
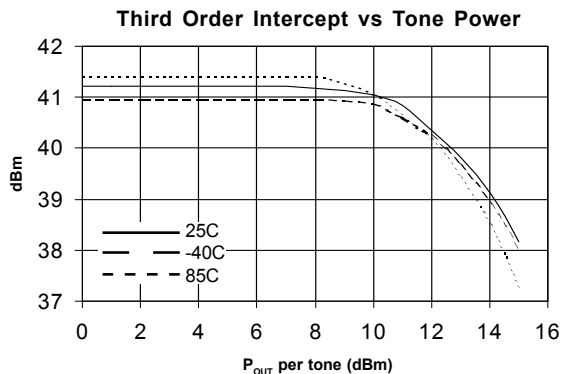
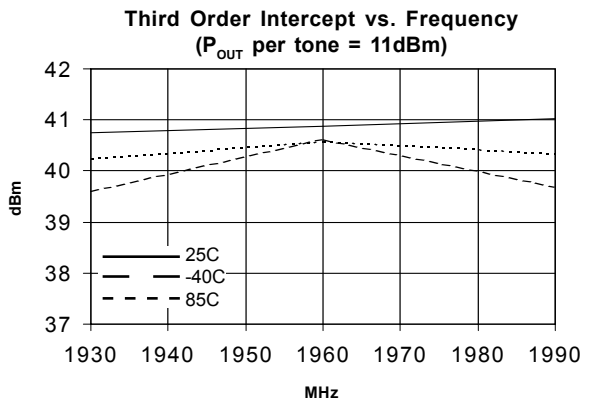
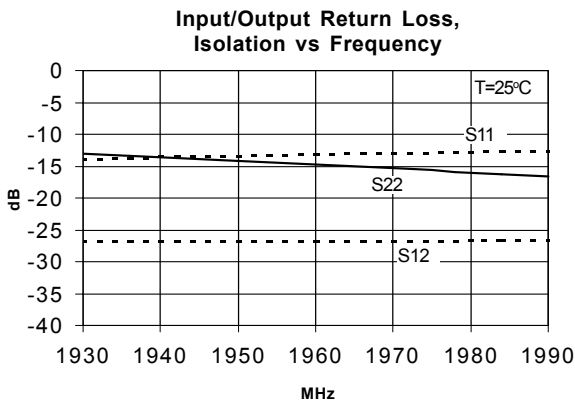
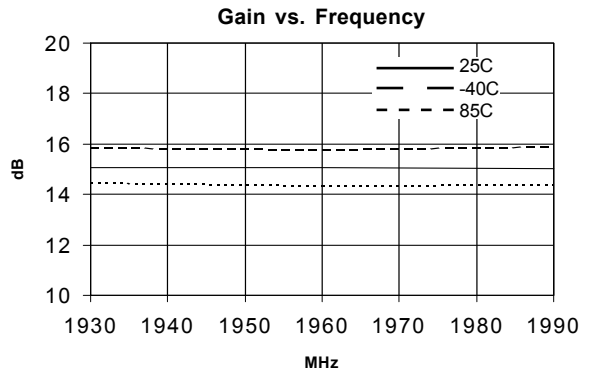
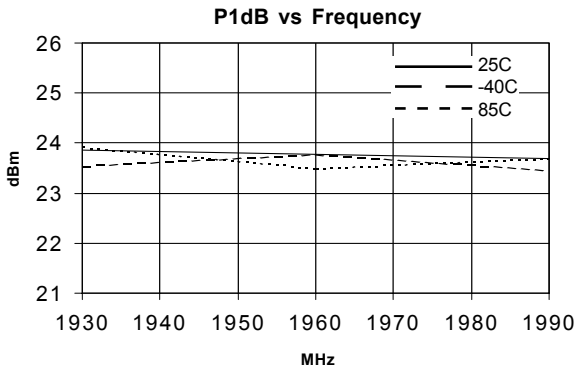

SXT-289 1800-2500 MHz Power Amplifier

2140 MHz Application Circuit Data, $V_s=8V$, $I_D=105mA$, $R_{BIAS}=27\ \Omega$

Note: Tuned for Output IP3

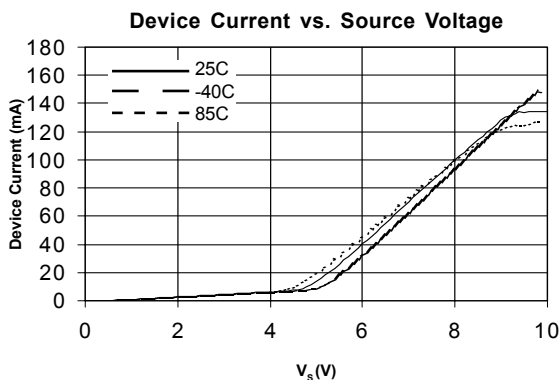
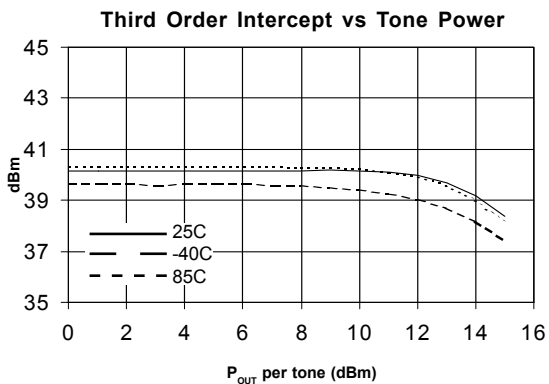
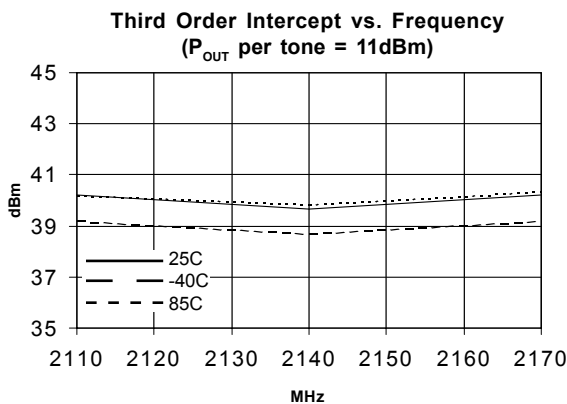
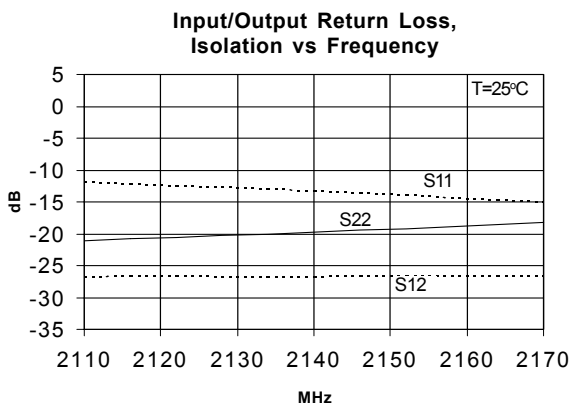
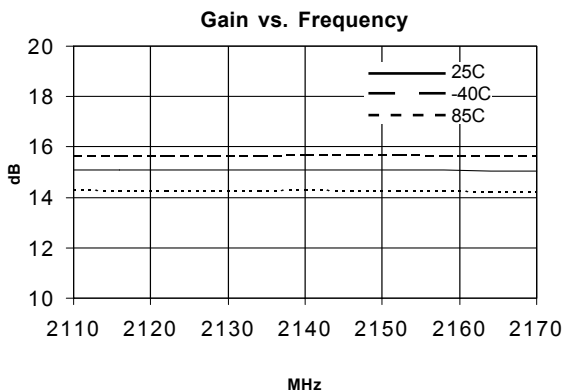
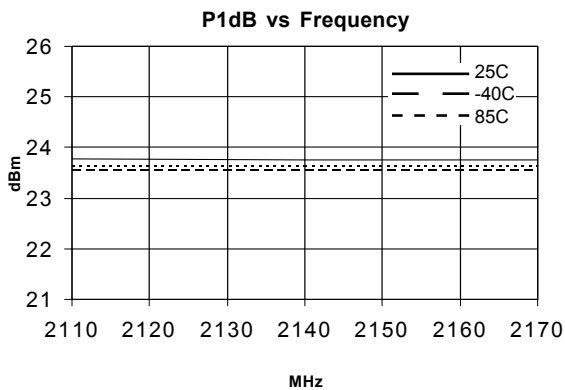

SXT-289 1800-2500 MHz Power Amplifier

2450 MHz Application Circuit Data, $V_s=8V$, $I_D=105mA$, $R_{BIAS}=27\ \Omega$

Note: Tuned for Output IP3

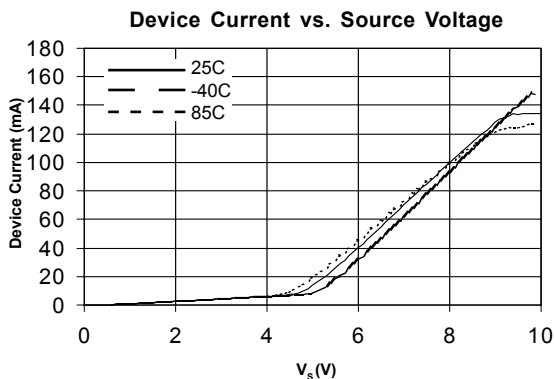
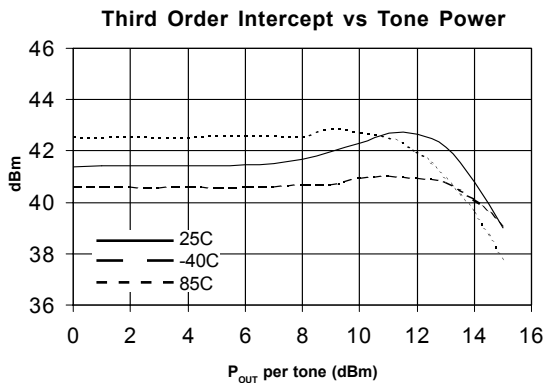
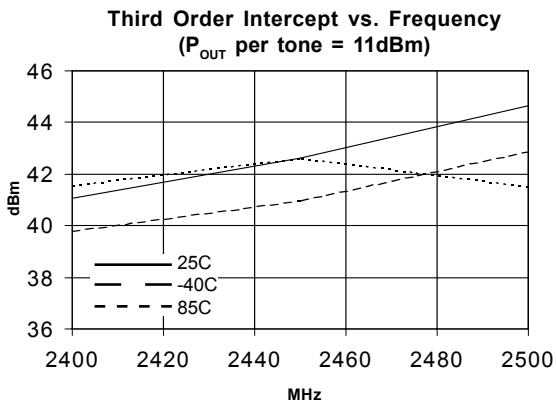
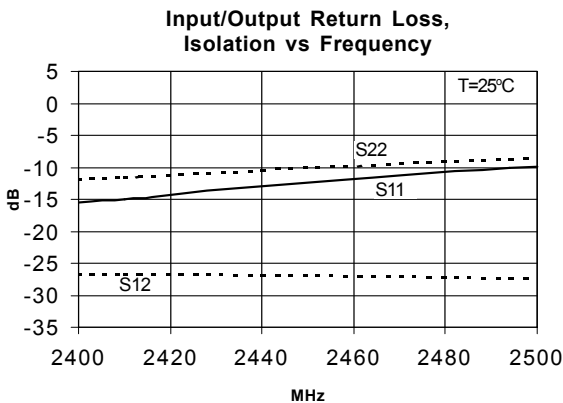
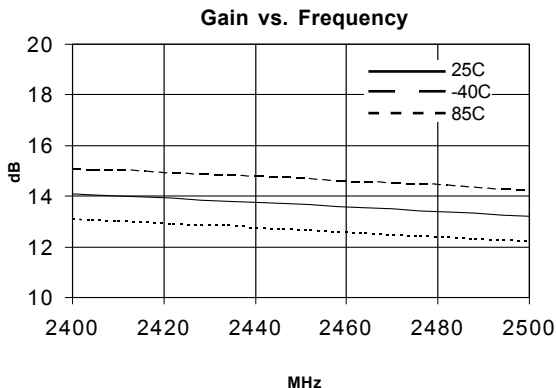
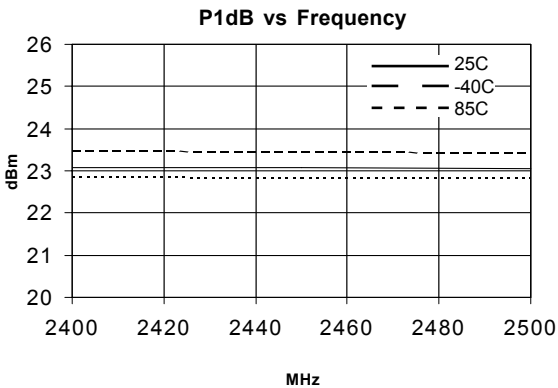

**1960 MHz Application Circuit Data, $V_s=8V$, $I_D=105mA$, $R_{BIAS}=27\ \Omega$
IS-95, 9 Channels Forward**

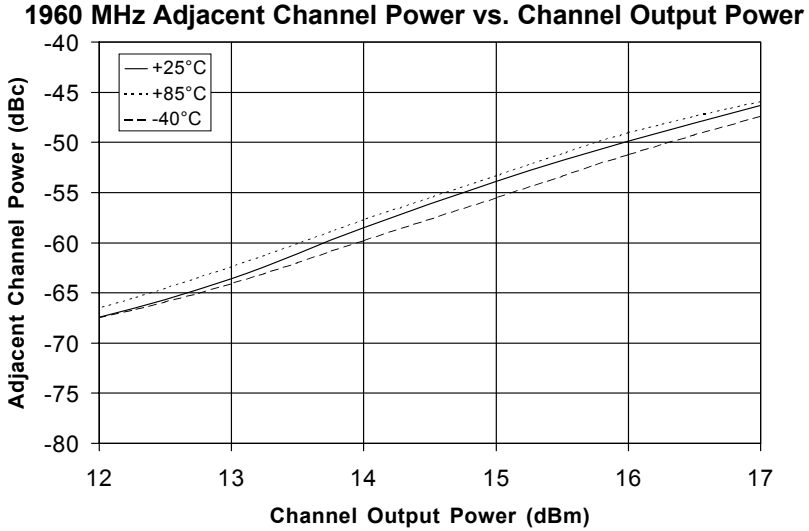

IS-95 CDMA at 1960 MHz

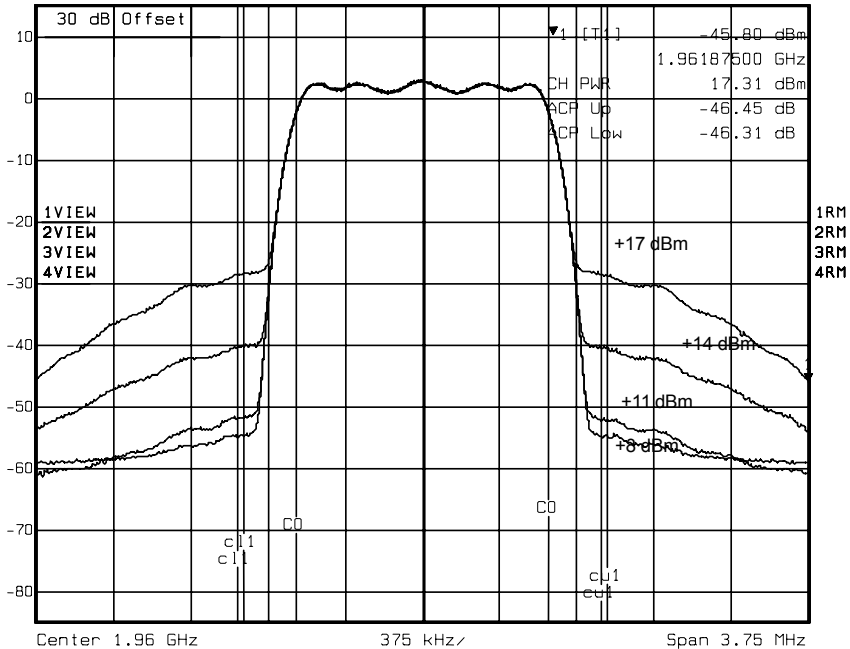

SXT-289 1800-2500 MHz Power Amplifier

2140 MHz Application Circuit Data, $V_S=8V$, $I_D=105mA$, $R_{BIAS}=27\ \Omega$

The W-CDMA setup is PCCPCH+PSCH+SSCH+CPICH+PICH+64 DPCH

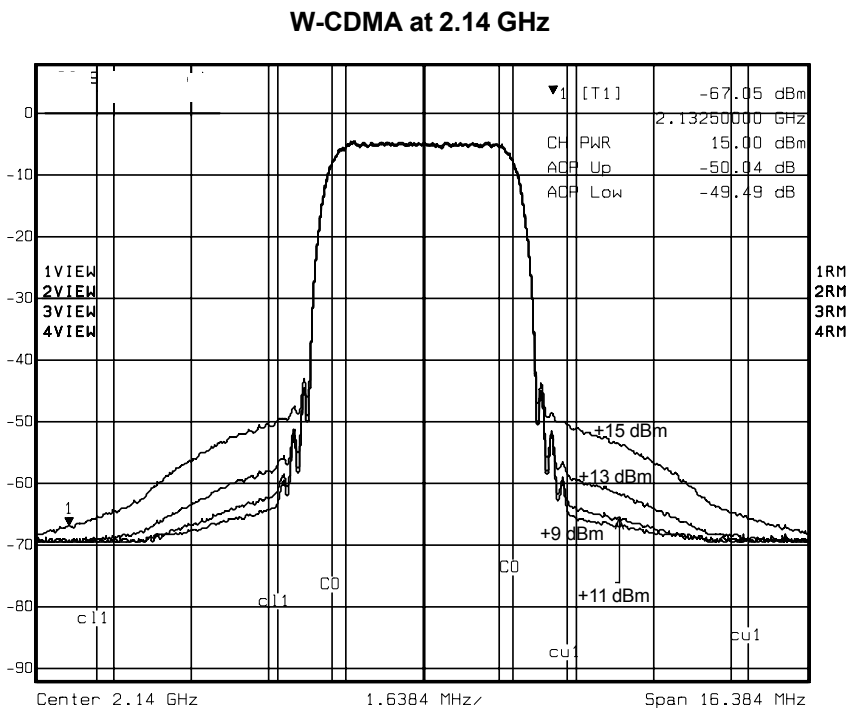
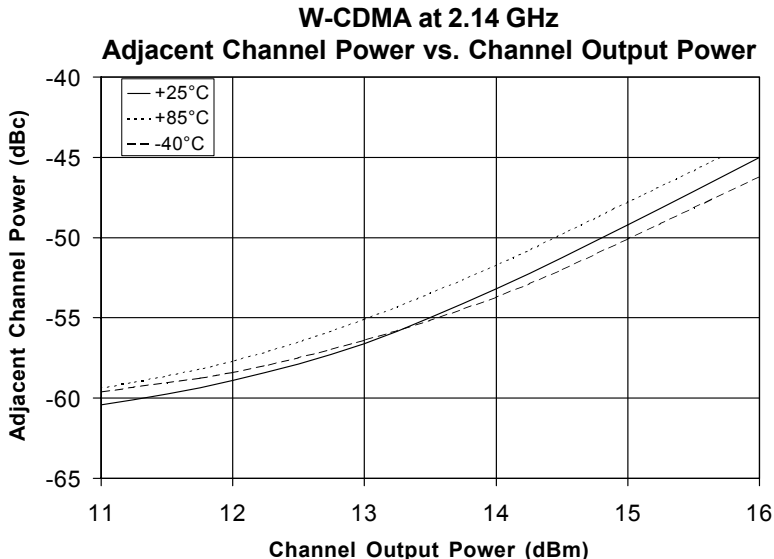

SXT-289 1800-2500 MHz Power Amplifier

Voltage Feed Resistor Bias Circuit (for > 7V supply)

Note: Circuit Optimized for Output IP3

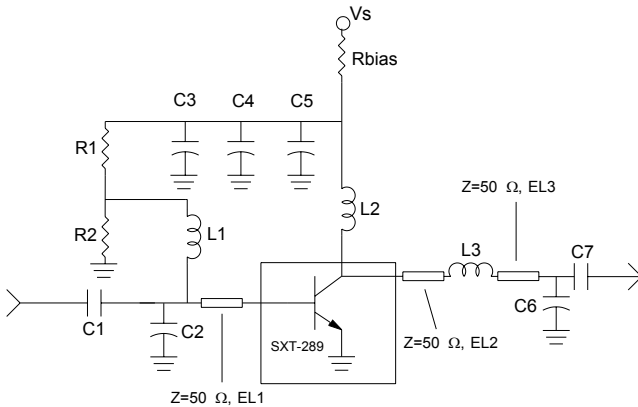

Schematic

Recommended Bias Resistor Values				
Supply Voltage(Vs)	7V	8V	10V	12V
Rbias (Ohms)	18	27	47	62
Power Rating	0.5W	1.0W	1.5W	2.0W

Ref. Des.	1960 MHz	2140 MHz	2450 MHz	Part Number
C1, C7	39pF	39pF	39pF	Rohm MCH18 series
C2	0.5pF	-	-	Rohm MCH18 series
C3	0.1uF	0.1uF	0.1uF	Matsuo 267M3502104K
C4	1000pF	1000pF	1000pF	Rohm MCH18 series
C5	18pF	18pF	18pF	Rohm MCH18 series
C6	1.0pF	1.0pF	1.0pF	Rohm MCH18 series
C6 Position	1	2	3	
L1, L2	15nH	15nH	15nH	Toko LL1608-FS series
L3	2.7nH	thru	thru	Toko LL1608-FS series
R1	390 Ohm	390 Ohm	390 Ohm	Rohm MCR03 series
R2	180 Ohm	180 Ohm	180 Ohm	Rohm MCR03 series
Rbias	see chart	see chart	see chart	
EL1	13.5°	-	-	
EL2	19°	-	-	
EL3	8.8°	* 56.7°	* 56°	* from output pin of SXT-289

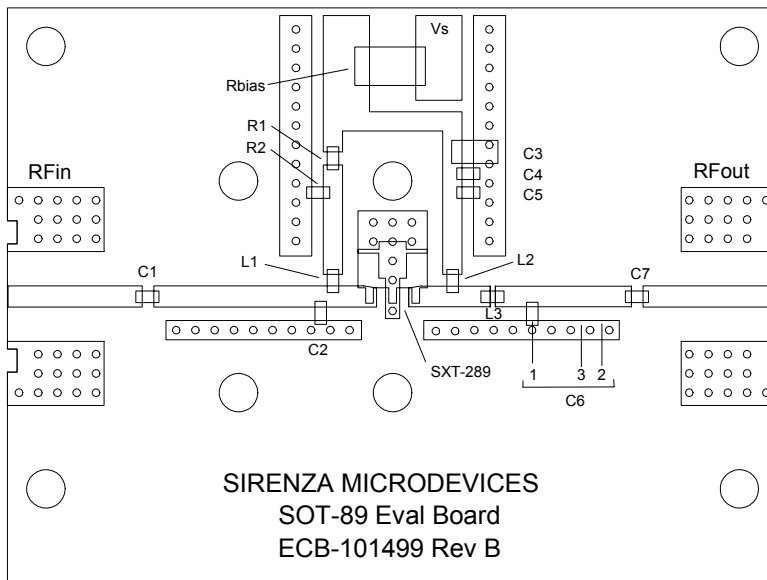

Evaluation Board Layout

SXT-289 1800-2500 MHz Power Amplifier

Active Current Feedback Bias Circuit (for 5V supply)

Note: Circuit Optimized for Output IP3

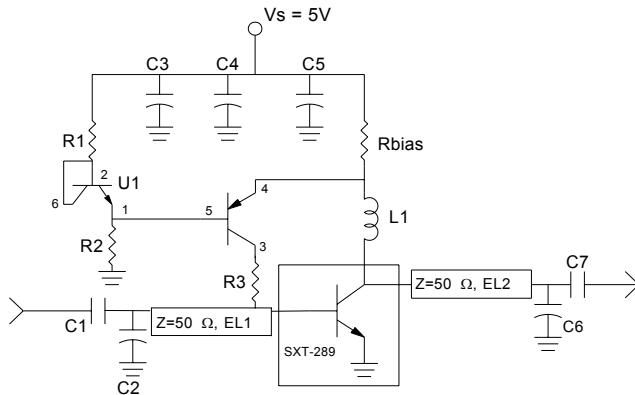

Schematic

Frequency	1960 MHz	2140 MHz	2450 MHz
Small Signal Gain (dB)	15.3	15.0	14.6
Output IP3 (dBm)	39.7*	39.2*	39.7*
P1dB (dBm)	23.8	23.0	23.7

*Note: IP3 performance degraded due to lower (4.5V) device voltage.

Ref. Des.	1960 MHz	2140 MHz	2450 MHz	Part Number
C1, C7	39pF	39pF	39pF	Rohm MCH18 series
C2	0.5pF	-	-	Rohm MCH18 series
C3	0.1uF	0.1uF	0.1uF	Matsuo 267M3502104K
C4	1000pF	1000pF	1000pF	Rohm MCH18 series
C5	22pF	22pF	22pF	Rohm MCH18 series
C6	1.0pF	1.0pF	1.0pF	Rohm MCH18 series
C6 Position	1	2	3	
L1	15nH	15nH	15nH	Toko LL1608-FS series
R1	220 Ohm	220 Ohm	220 Ohm	Rohm MCR03 series
R2	1.8KOhm	1.8KOhm	1.8KOhm	Rohm MCR03 series
R3	750 Ohm	750 Ohm	750 Ohm	Rohm MCR03 series
Rbias	4.3 Ohm	4.3 Ohm	4.3 Ohm	Rohm MCR03 series
U1	UMZ1N	UMZ1N	UMZ1N	Rohm
EL1	13.5°	-	-	
EL2	35.5°	49.8°	40.9°	

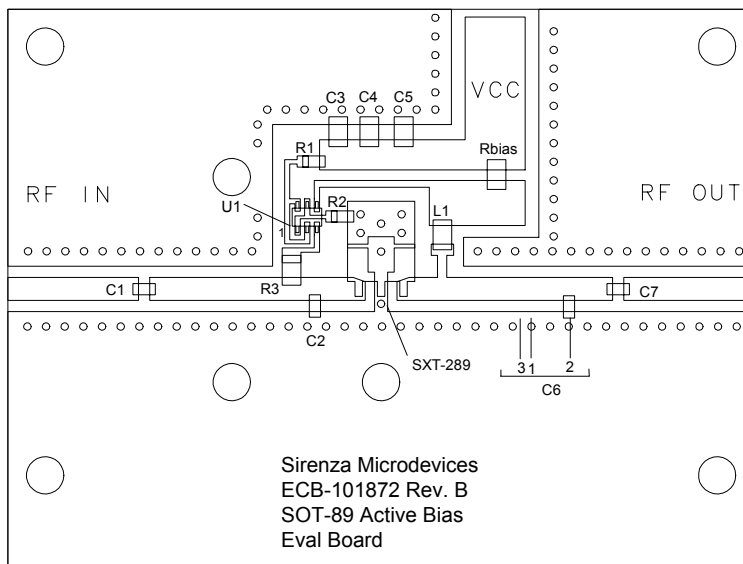

Evaluation Board Layout

NOTE: Reference Application Note AN-026 for more information on Active Current Bias Circuit.

Absolute Maximum Ratings

Parameter	Absolute Limit
Max. Supply Current (I_b)	200 mA
Max. Device Voltage (V_b)	6.0 V
Max. Power Dissipation	1500 mW
Max. RF Input Power	100 mW
Max. Junction Temp. (T_j)	+150 °C
Operating Lead Temp. (T_l)	-40 to +85 °C
Max. Storage Temp.	+150 °C

Operation of this device beyond any one of these limits may cause permanent damage. For reliable continuous operation, the device voltage and current must not exceed the maximum operating values specified in the table on page one.

Bias Conditions should also satisfy the following expression:
 $I_b V_b (max) < (T_j - T_l) R_{\theta j-l}$



Caution: ESD sensitive

Appropriate precautions in handling, packaging and testing devices must be observed.

SXT-289 1800-2500 MHz Power Amplifier

Part Number Ordering Information

Part Number	Devices Per Reel	Reel Size
SXT-289	1000	7"

Part Symbolization

The part will be symbolized with a "XT2" designator on the top surface of the package.

Pin Description

Pin #	Function	Description
1	Base	Base Pin
2	GND & Emitter	Connection to ground. Use via holes to reduce lead inductance. Place vias as close to ground leads as possible.
3	Collector	Collector Pin
4	GND & Emitter	Same as Pin 2

Package Dimensions

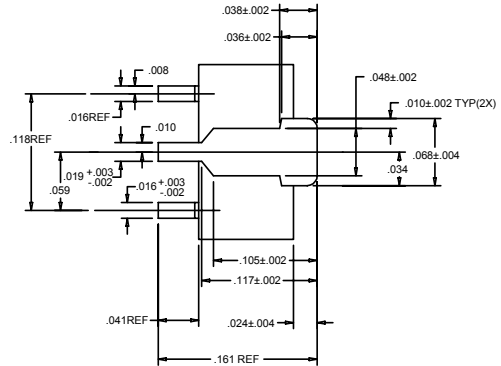
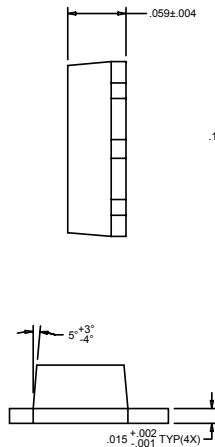
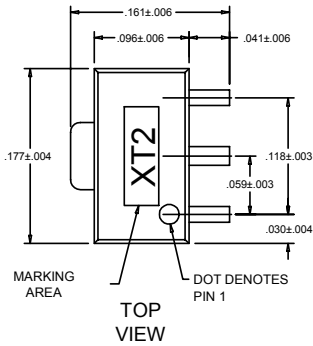

PCB Pad Layout

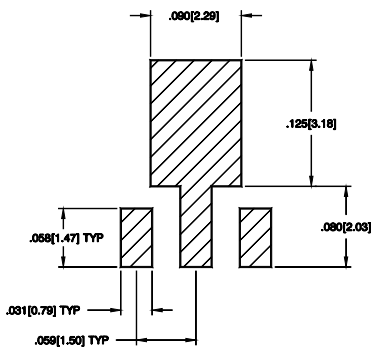

DIMENSIONS ARE IN INCHES [MM]

Recommended Mounting Configuration for Optimum RF and Thermal Performance

