

\*RoHS COMPLIANT

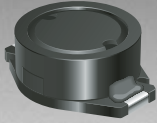

**BOURNS®**

### Features

- Available in E12 series
- Low profile - 4.7 mm unit height
- High current
- Lead free
- RoHS compliant\*

### Applications

- Input/output of DC/DC converters
- Power supplies for:
  - Portable communication equipment
  - Camcorders
  - LCD TVs
  - Car radios

## SRR0805 Series - Shielded Power Inductor

### Electrical Specifications

Bourns Part No.	Inductance 1kHz		Q Ref.	Test Frequency (MHz)	SRF Min. (MHz)	RDC (Ω)	I rms Max. (A)	I sat Typ. (A)
	(μH)	Tol. %						
SRR0805-2R2M	2.2	± 20	18	7.96M	75.0	0.040	2.50	4.90
SRR0805-3R9M	3.9	± 20	20	7.96M	50.0	0.055	2.10	3.70
SRR0805-5R6M	5.6	± 20	20	7.96M	40.0	0.065	1.95	3.20
SRR0805-8R2M	8.2	± 20	19	7.96M	32.0	0.080	1.75	2.50
SRR0805-100M	10	± 20	40	2.52M	28.0	0.100	1.50	2.20
SRR0805-120M	12	± 20	40	2.52M	24.0	0.120	1.40	2.10
SRR0805-150M	15	± 20	40	2.52M	22.0	0.140	1.30	1.80
SRR0805-180Y	18	± 15	40	2.52M	19.0	0.160	1.20	1.70
SRR0805-220Y	22	± 15	38	2.52M	19.0	0.180	1.10	1.50
SRR0805-270Y	27	± 15	35	2.52M	15.5	0.200	1.00	1.40
SRR0805-330Y	33	± 15	40	2.52M	13.5	0.240	0.92	1.20
SRR0805-390Y	39	± 15	35	2.52M	12.0	0.260	0.84	1.10
SRR0805-470Y	47	± 15	32	2.52M	10.5	0.280	0.75	1.00
SRR0805-560K	56	± 10	30	2.52M	9.5	0.380	0.68	0.95
SRR0805-680K	68	± 10	28	2.52M	9.0	0.440	0.60	0.90
SRR0805-820K	82	± 10	28	2.52M	8.5	0.550	0.54	0.74
SRR0805-101K	100	± 10	45	0.796M	7.5	0.600	0.50	0.70
SRR0805-121K	120	± 10	42	0.796M	7.0	0.750	0.45	0.66
SRR0805-151K	150	± 10	39	0.796M	6.5	0.90	0.40	0.64
SRR0805-181K	180	± 10	41	0.796M	4.8	1.05	0.35	0.62
SRR0805-221K	220	± 10	38	0.796M	4.5	1.18	0.30	0.55
SRR0805-271K	270	± 10	37	0.796M	4.2	1.40	0.27	0.45
SRR0805-331K	330	± 10	36	0.796M	3.8	1.80	0.24	0.38
SRR0805-391K	390	± 10	35	0.796M	3.6	2.10	0.22	0.36
SRR0805-471K	470	± 10	34	0.796M	3.5	2.25	0.20	0.35
SRR0805-561K	560	± 10	32	0.796M	3.0	3.00	0.18	0.34
SRR0805-681K	680	± 10	32	0.796M	2.8	3.40	0.17	0.32
SRR0805-821K	820	± 10	35	0.796M	2.5	4.00	0.16	0.29
SRR0805-102K	1000	± 10	35	0.252M	2.2	5.00	0.15	0.24

### General Specifications

Test Voltage.....1 V  
 Reflow soldering.....250 °C; 10 sec max.  
 (In compliance with JEDEC, J-STD-020C, Table 4-2)  
 Operating Temperature -40 °C to +125 °C  
 (Temperature rise included)  
 Storage Temperature...-40 °C to +125 °C  
 Resistance to Soldering Heat  
 .....250 °C, 10 sec. max.

### Materials

Core .....Ferrite DR&RI  
 Wire .....Enameled copper  
 Base .....LCP E4008  
 Terminal.....Cu/Ni/Sn  
 Rated Current  
 .....Ind. drop 10 % typ. at Isat  
 Temperature Rise  
 .....40 °C max. at rated I rms  
 Packaging.....1000 pcs. per reel

### Product Dimensions

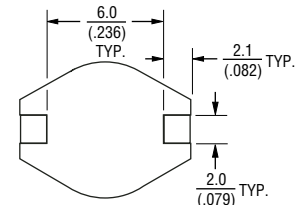
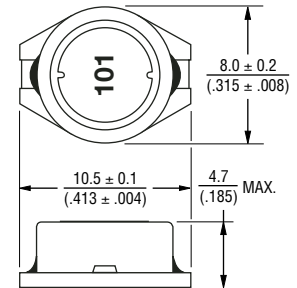

DIMENSIONS:  $\frac{\text{MM}}{\text{(INCHES)}}$

### Recommended Layout

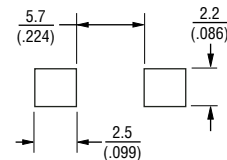

### Soldering Profile

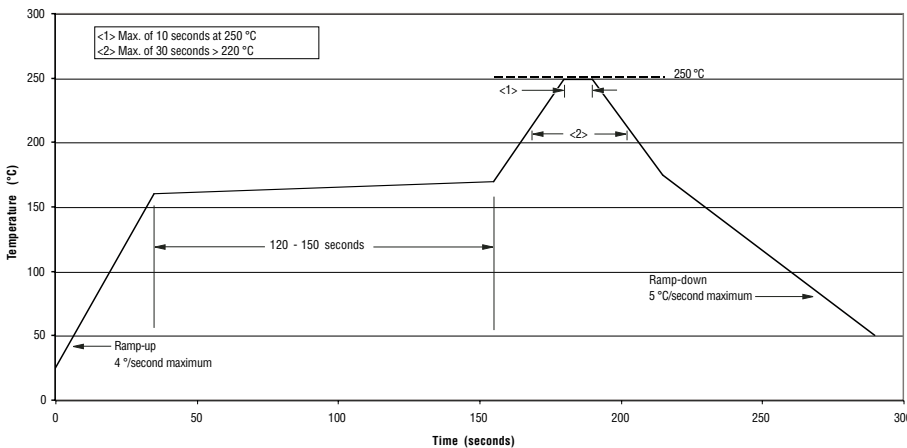

\*RoHS Directive 2002/95/EC Jan 27 2003 including Annex Specifications are subject to change without notice. Customers should verify actual device performance in their specific applications.

# SRR0805 Series - Shielded Power Inductor

**BOURNS®**

## Packaging Specifications

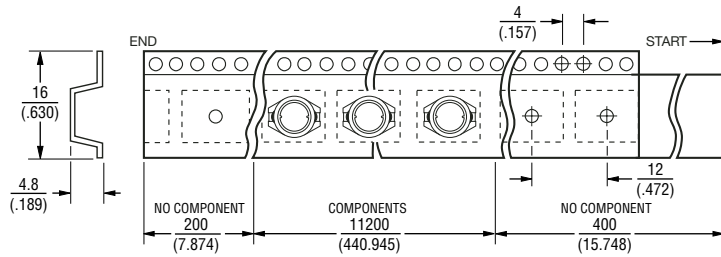
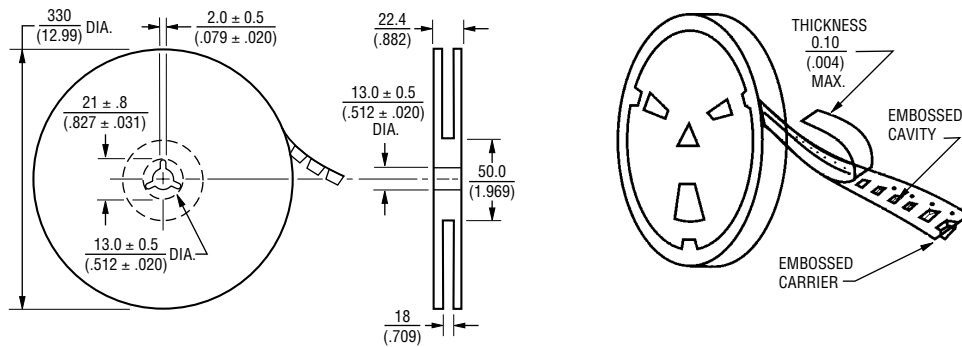

**USER DIRECTION OF FEED** →  
QTY: 1000 PCS. PER REEL

DIMENSIONS:  $\frac{\text{MM}}{\text{(INCHES)}}$

REV. 02/06

Specifications are subject to change without notice.  
Customers should verify actual device performance in their specific applications.