

Dual N-Channel Enhancement Mode MOSFET

(Pb) Lead(Pb)-Free

Features:

- *Super High Dense Cell Design For Low $R_{DS(ON)}$
 $R_{DS(ON)} < 80m\Omega @ V_{GS}=4.5V$
- *Rugged and Reliable
- *Capable of 2.5V Gate Drive
- *Simple Drive Requirement
- *SOT-26 Package

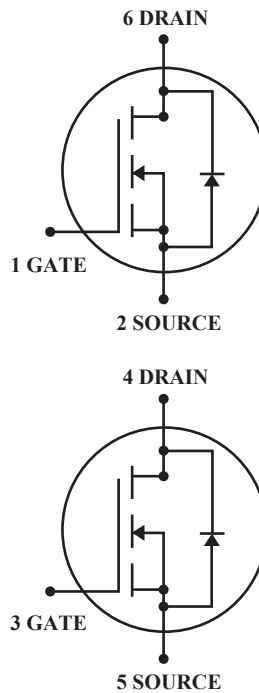

DRAIN CURRENT
2.5 AMPERES
DRAIN SOURCE VOLTAGE
20 VOLTAGE

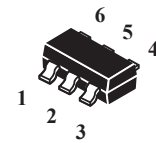

SOT-26

Maximum Ratings ($T_A=25^\circ C$ Unless Otherwise Specified)

Rating	Symbol	Value	Unit
Drain-Source Voltage	V_{DS}	20	V
Gate-Source Voltage	V_{GS}	± 10	
Continuous Drain Current ¹ , $V_{GS}@4.5V$, $T_A=25^\circ C$ -Pulsed ²	I_D	2.5	A
	I_{DM}	8	
Drain-Source Diode Forward Current ¹	I_S	1.25	
Total Power Dissipation ¹ ($T_A=25^\circ C$)	P_D	1	W
Maximum Junction-ambient ¹	$R_{\theta JA}$	125	$^\circ C/W$
Operating Junction and Storage Temperature Range	T_J, T_{stg}	-55~+150	$^\circ C$

Device Marking

WTL2622=STS2622

Electrical Characteristics ($T_A = 25^\circ\text{C}$ Unless otherwise noted)

Characteristic	Symbol	Min	Typ ³	Max	Unit
----------------	--------	-----	------------------	-----	------

OFF Characteristics

Drain-Source Breakdown Voltage $V_{GS}=0, I_D=250\mu\text{A}$	BV_{DSS}	20	-	-	V
Drain-Source Leakage Current $V_{DS}=16\text{V}, V_{GS}=0\text{V}$	I_{DSS}	-	-	1	μA
Gate-Source Leakage current $V_{GS}=\pm 10\text{V}, V_{DS}=0\text{V}$	I_{GSS}	-	-	± 100	nA

ON Characteristics²

Gate-Source Threshold Voltage $V_{DS}=V_{GS}, I_D=250\mu\text{A}$	$V_{GS(Th)}$	0.5	0.8	1.5	V
Drain-Source On-Resistance $V_{GS}=4.5\text{V}, I_D=2.5\text{A}$ $V_{GS}=2.5\text{V}, I_D=2.0\text{A}$	$R_{DS(on)}$	-	65 90	80 110	$\text{m}\Omega$
On-State Drain Current $V_{DS}=5\text{V}, V_{GS}=4.5\text{V}$	$I_{D(ON)}$	6	-	-	A
Forward Transconductance $V_{DS}=5\text{V}, I_D=2.5\text{A}$	gfs	-	7	-	S

Dynamic Characteristics³

Input Capacitance $V_{GS}=0\text{V}, V_{DS}=10\text{V}, f=1.0\text{MHz}$	C_{iss}	-	220	-	pF
Output Capacitance $V_{GS}=0\text{V}, V_{DS}=10\text{V}, f=1.0\text{MHz}$	C_{oss}	-	67	-	
Reverse Transfer Capacitance $V_{GS}=0\text{V}, V_{DS}=10\text{V}, f=1.0\text{MHz}$	C_{rss}	-	50	-	

Electrical Characteristics ($T_A = 25^\circ\text{C}$ Unless otherwise noted)

Characteristic	Symbol	Min	Typ ³	Max	Unit
----------------	--------	-----	------------------	-----	------

Switching Characteristics³

Turn-on Delay Time ² $V_{DS}=10\text{V}, V_{GS}=4.5\text{V}, I_D=1\text{A}, R_{GEN}=6\Omega$	$t_{d(on)}$	-	10.2	-	ns
Rise Time $V_{DS}=10\text{V}, V_{GS}=4.5\text{V}, I_D=1\text{A}, R_{GEN}=6\Omega$	t_r	-	8.3	-	
Turn-off Delay Time $V_{DS}=10\text{V}, V_{GS}=4.5\text{V}, I_D=1\text{A}, R_{GEN}=6\Omega$	$t_{d(off)}$	-	13.5	-	
Fall Time $V_{DS}=10\text{V}, V_{GS}=4.5\text{V}, I_D=1\text{A}, R_{GEN}=6\Omega$	t_f	-	12.7	-	
Total Gate Charge ² $V_{DS}=10\text{V}, V_{GS}=4.5\text{V}, I_D=2.5\text{A}$	Q_g	-	4	-	nC
Gate-Source Charge $V_{DS}=10\text{V}, V_{GS}=4.5\text{V}, I_D=2.5\text{A}$	Q_{gs}	-	1.5	-	
Gate-Source Change $V_{DS}=10\text{V}, V_{GS}=4.5\text{V}, I_D=2.5\text{A}$	Q_{gd}	-	0.7	-	

Source-Drain Diode Characteristics²

Forward On Voltage $V_{GS}=0\text{V}, I_S=1.25\text{A}$	V_{SD}	-	0.84	1.2	V
--	----------	---	------	-----	---

- Note: 1. Surface mounted on 1 in2 copper pad of FR4 board, $t \leq 10\text{sec}$.
 2. Pulse Test : Pulse width $\leq 300\mu\text{s}$, duty cycle $\leq 2\%$.
 3. Guaranteed by design, not subject to production testing.

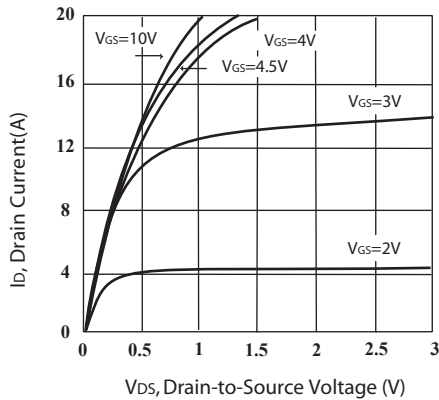

Fig.1 Output Characteristics

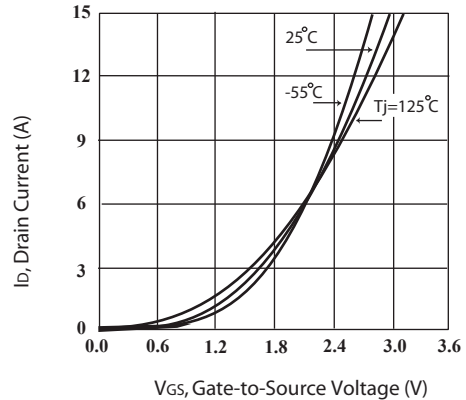

Fig.2 Transfer Characteristics

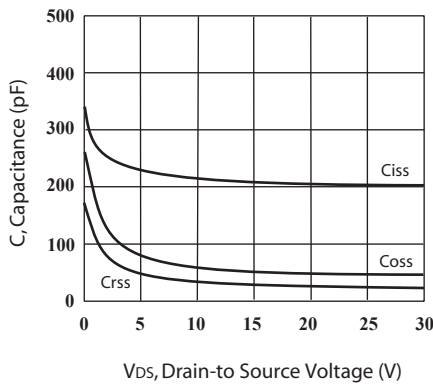

Fig.3 Capacitance with Drain to Source Voltage

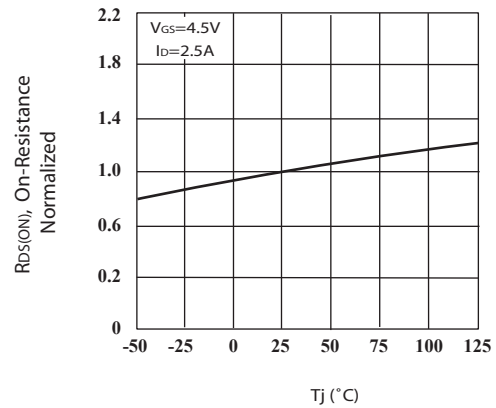

Fig.4 On-Resistance Variation with Temperature

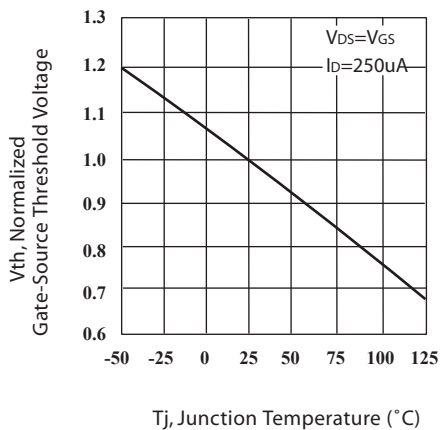

Fig.5 Gate Threshold Voltage Variation with Temperature

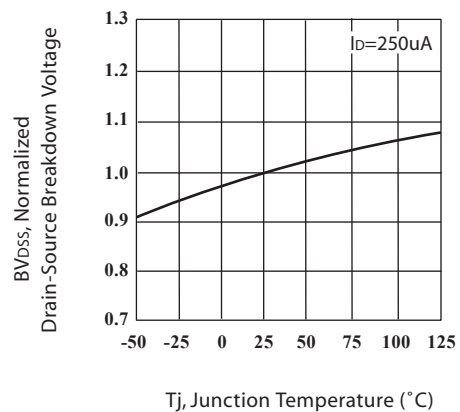

Fig.6 Breakdown Voltage Variation with Temperature

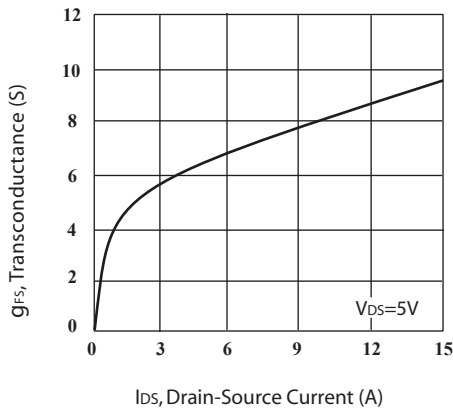

Fig.7 Transconductance Variation with Drain Current

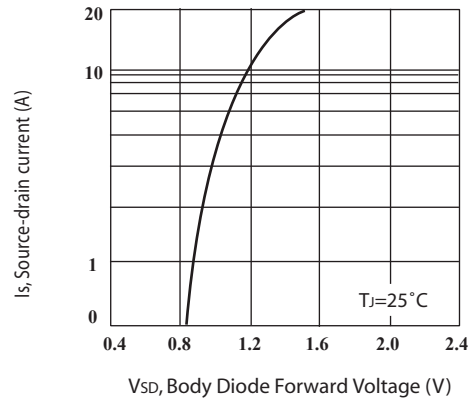

Fig.8 Body Diode Forward Voltage Variation with Source Current

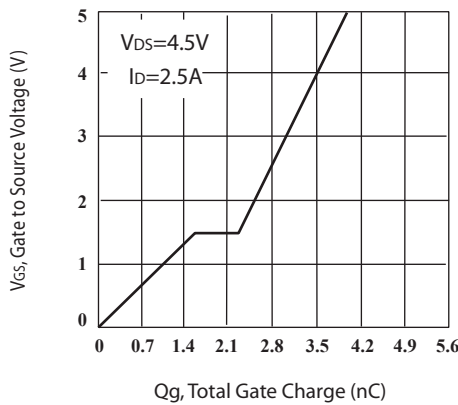

Fig.9 Gate Charge

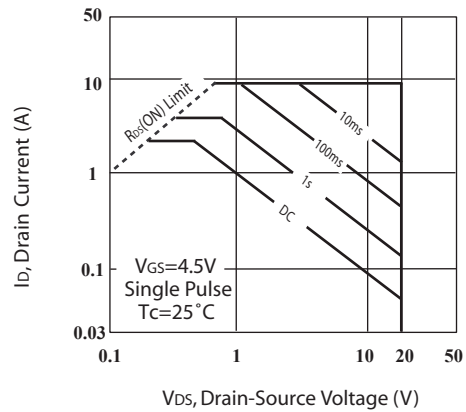

Fig.10 Maximum Safe Operating Area

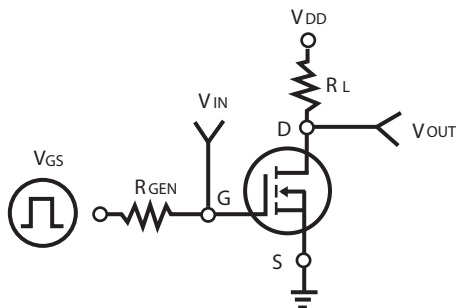

Fig.11 Switching Test Circuit

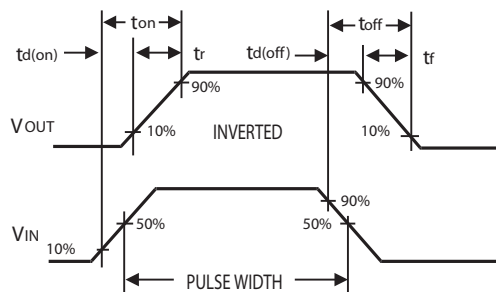
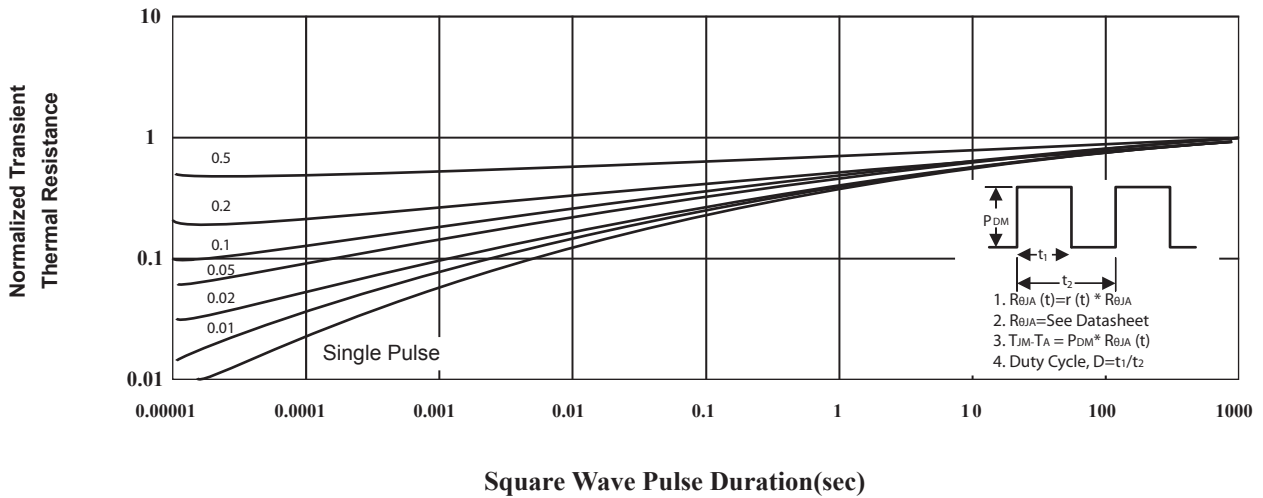

Fig.12 Switching Waveforms



Square Wave Pulse Duration(sec)
Normalized Thermal Transient Impedance Curve

SOT-26 Outline Dimension

Unit:mm

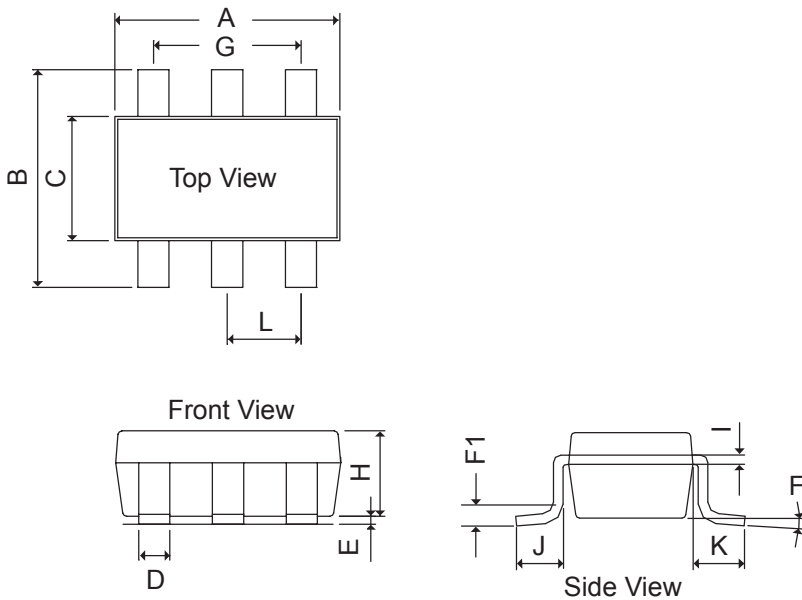

SOT-26		
Dim	Min	Max
A	2.70	3.10
B	2.60	3.00
C	1.40	1.80
D	0.30	0.55
E	0.00	0.10
F	0°	10°
F1	0.08	0.25
G	1.90 REF	
H	1.20 REF	
I	0.12 REF	
J	0.37 REF	
K	0.60 REF	
L	0.95 REF	