

### NPN General Purpose Transistor

 Lead(Pb)-Free

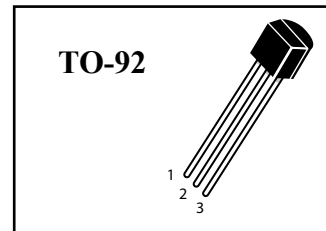
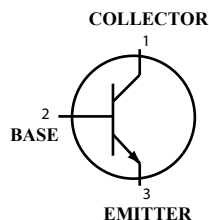

### Maximum Ratings ( $T_A=25^\circ\text{C}$ unless otherwise noted)

Rating	Symbol	BC337	BC338	Unit
Collector-Base voltage	$V_{CBO}$	50	30	V
Collector-Emitter voltage	$V_{CEO}$	45	25	V
Emitter-Base voltage	$V_{EBO}$	5.0	5.0	V
Collector Current Continuous	$I_C$	800		mA
Total Device Dissipation Alumina Substrate, $T_A=25^\circ\text{C}$	$P_D$	625		mW/ $^\circ\text{C}$
Operating Junction Temperature Range	$T_J$	-55 to +150		$^\circ\text{C}$
Storage Junction Temperature Range	$T_{stg}$	-55 to +150		$^\circ\text{C}$

### ELECTRICAL CHARACTERISTICS

Characteristics	Symbol	Min	Typ	Max	Unit
-----------------	--------	-----	-----	-----	------

### OFF CHARACTERISTICS

Collector-Base Breakdown Voltage $I_C=100\mu\text{A}$ , $I_E=0$	BC337 BC338	$V_{(BR)CBO}$	50 30	-	-	V
Collector-Emitter Breakdown Voltage $I_C=10\text{mA}$ , $I_B=0$	BC337 BC338	$V_{(BR)CEO}$	45 25	-	-	V
Emitter-Base Breakdown Voltage $I_C=10\mu\text{A}$ , $I_C=0$	BC337 BC338	$V_{(BR)EBO}$	5.0	-	-	Vdc

## ELECTRICAL CHARACTERISTICS ( $T_A=25^\circ\text{C}$ unless otherwise noted) (Continued)

Characteristics	Symbol	Min	Typ	Max	Unit
-----------------	--------	-----	-----	-----	------

### OFF CHARACTERISTICS

Collector Cut-off Current $V_{CE}=40\text{V}, I_B=0$ $V_{CE}=20\text{V}, I_B=0$	BC337 BC338	$I_{CEO}$	-	-	0.2	$\mu\text{A}$
Collector Cut-off Current $V_{CB}=45\text{V}, I_E=0$ $V_{CB}=25\text{V}, I_E=0$	BC337 BC338	$I_{CBO}$	-	-	0.1	$\mu\text{A}$
Emitter Cutoff Current $V_{EB}=4.0\text{V}, I_C=0$		$I_{EBO}$	-	-	0.1	$\mu\text{A}$

### ON CHARACTERISTICS

DC Current Gain $V_{CE}=1\text{V}, I_C=100\text{mA}$ $V_{CE}=1\text{V}, I_C=300\text{mA}$	$h_{FE1}$ $h_{FE2}$	100 60	-	630 -	-
Collector-Emitter Saturation Voltage $I_C=500\text{mA}, I_B=50\text{mA}$	$V_{CE(sat)}$	-	-	0.7	V
Base-Emitter Saturation Voltage $I_C=500\text{mA}, I_B=50\text{mA}$	$V_{BE(sat)}$	-	-	1.2	V
Transition frequency $V_{CE}=5\text{V}, I_C=10\text{mA}, f=100\text{MHz}$	$f_T$	210	-	-	MHz

### $h_{FE}$ Classification

Classification	16	25	40
$h_{FE1}$	100 ~ 250	160 ~ 400	250 ~ 630
$h_{FE2}$	60-	100-	170-

## Typical Characteristics

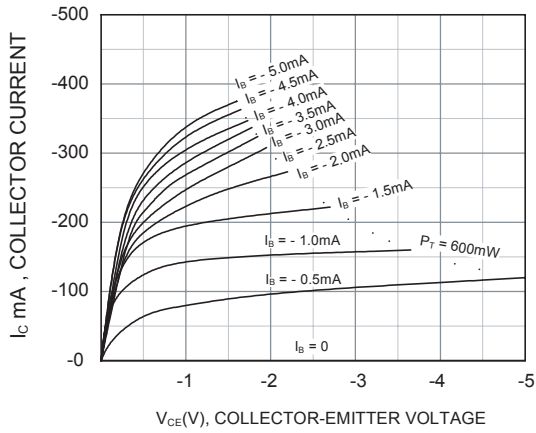

**Figure 1. Static Characteristic**

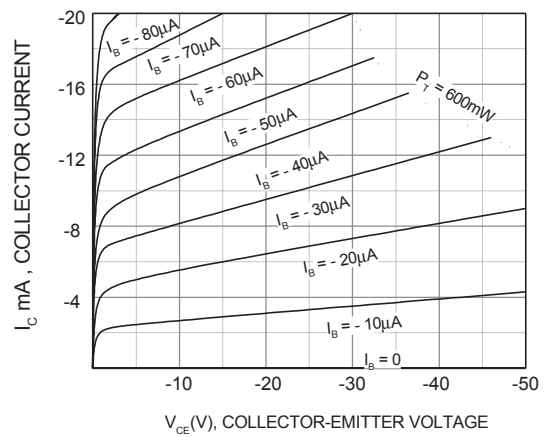

**Fig.2 Static Characteristic**

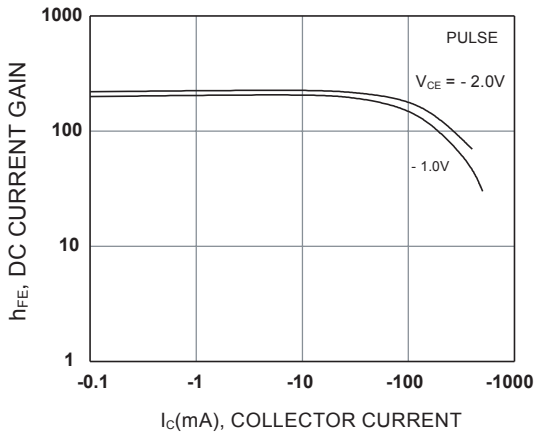

**Figure 3. DC current Gain**

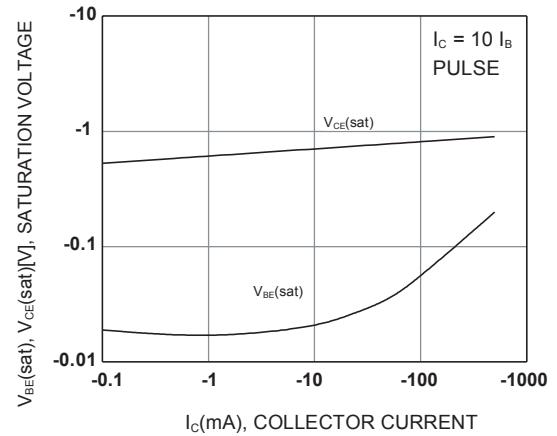

**Fig.4 Base-Emitter Saturation Voltage  
Collector-Emitter Saturation Voltage**

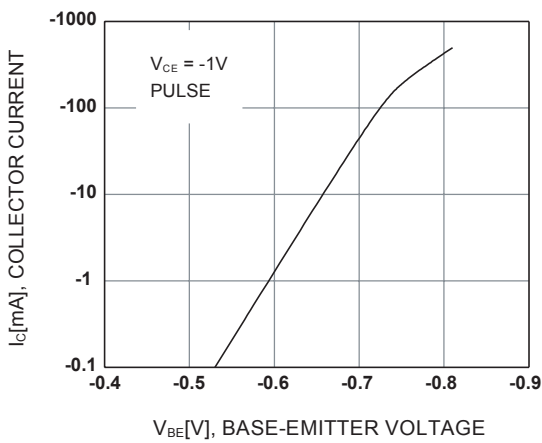

**Fig.5 Base-Emitter On Voltage**

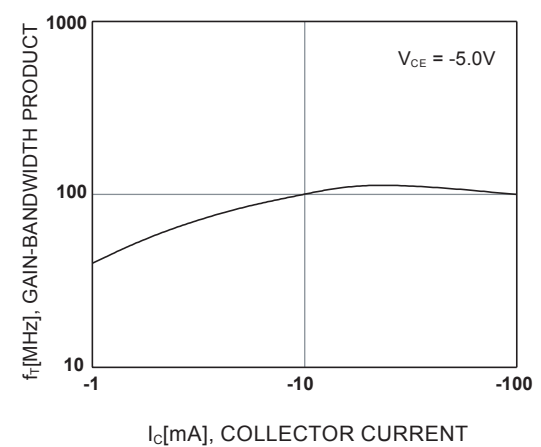

**Fig.6 Gain Bandwidth Product**

**TO-92 Outline Dimensions**

unit:mm

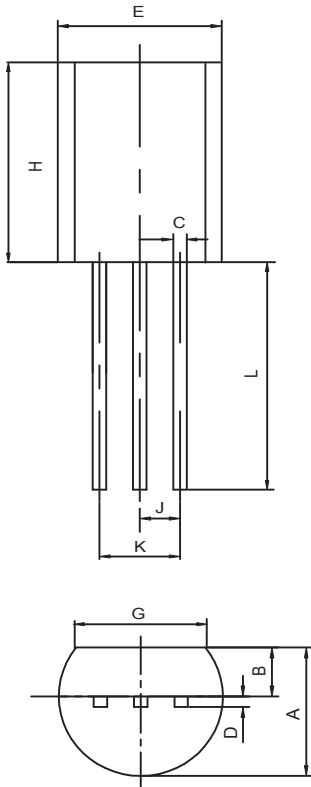

TO-92		
Dim	Min	Max
A	3.30	3.70
B	1.10	1.40
C	0.38	0.55
D	0.36	0.51
E	4.40	4.70
G	3.43	-
H	4.30	4.70
J	1.270TYP	
K	2.44	2.64
L	14.10	14.50