

# NPN Silicon Phototransistors

## Types OP841W, OP842W, OP843W, OP844W, OP845W

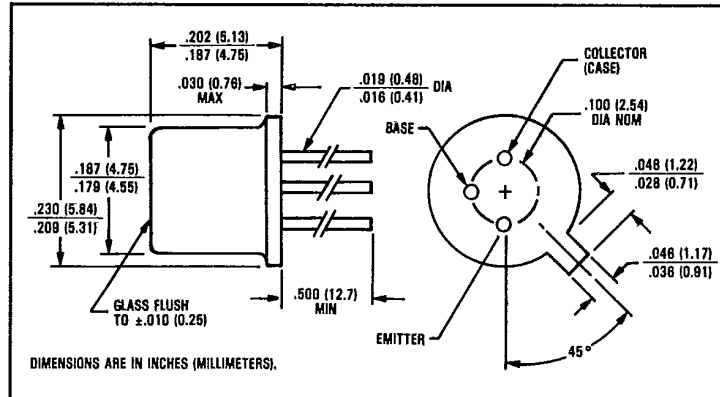
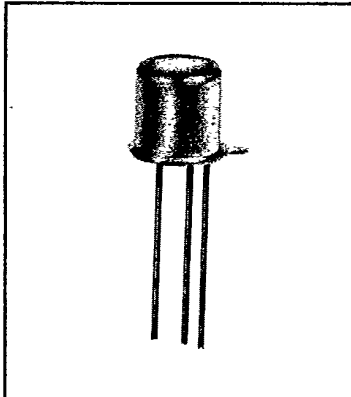

### Features

- Collector currents specified as minimums
- Flat lensed for wide acceptance angle
- TO-18 hermetically sealed package

### Description

The OP841W through OP845W each consist of an NPN silicon phototransistor mounted in a flat lensed, hermetically sealed, TO-18 package. The flat lens allows an acceptance half angle of 40° measured from the optical axis to the half power point. The base lead is bonded to enable conventional transistor biasing. Except for minor differences in collector current ranges and minimum range binning only, this series is identical to the OP800W series and is mechanically and spectrally matched to the OP130W and OP231W series of infrared emitting diodes.

### Absolute Maximum Ratings (T<sub>A</sub> = 25°C unless otherwise noted)

Collector-Base Voltage	.....	.30 V
Collector-Emitter Voltage	.....	.30 V
Emitter-Base Voltage	.....	.5.0 V
Emitter-Collector Voltage	.....	.5.0 V
Continuous Collector Current	.....	.50 mA
Storage Temperature Range	.....	-.65°C to +150°C
Operating Temperature Range	.....	-.65°C to +125°C
Lead Soldering Temperature (1/16 inch [1.6 mm] from case for 5 sec. with soldering iron) <sup>(1)</sup>	.....	.240°C
Power Dissipation	.....	.260 mW <sup>(2)</sup>

### Notes:

- (1) RMA flux is recommended. Duration can be extended to 10 sec. max. when wave soldering.
- (2) Derate linearly 2.5 mW/°C above 25°C.
- (3) Junction temperature maintained at 25°C.
- (4) Light source is an unfiltered tungsten bulb operating at CT = 2870°K or equivalent infrared source.

### Typical Performance Curves

**Spectral Response of OP841W-OP845W vs. GaAlAs and GaAs**

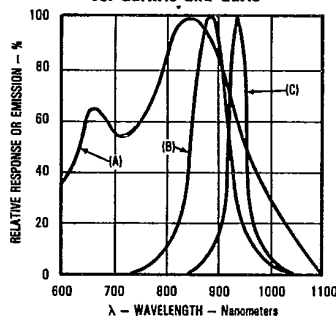

Test Conditions (LED): T<sub>A</sub> = T<sub>J</sub> = 25°C, I<sub>C</sub> = 100 mA, DC = 0.1%, PW = 100 μs  
Peak Wavelength - λ<sub>p</sub>: (A) XSTR - 650 ± 30 nm, (B) LED GaAlAs - 875 ± 20 nm, (C) LED GaAs - 930 ± 15 nm

**Coupling Characteristics of OP130W and OP840W**

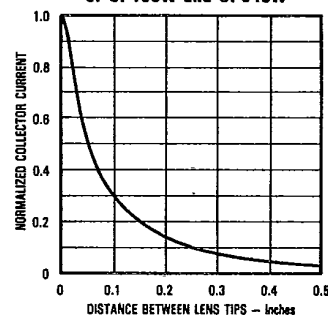

Types OP841W, OP842W, OP843W, OP844W, OP845W

T-41-6)

Electrical Characteristics (TA = 25°C unless otherwise noted)

Symbol	Parameter	Min.	Typ.	Max.	Units	Test Conditions	
IC(ON) <sup>(3)</sup>	On-State Collector Current	OP841W	0.30			mA	VCE = 5.0 V, Eg = 5.0 mW/cm <sup>2(4)</sup>
		OP842W	1.00			mA	VCE = 5.0 V, Eg = 5.0 mW/cm <sup>2(4)</sup>
		OP843W	1.50			mA	VCE = 5.0 V, Eg = 5.0 mW/cm <sup>2(4)</sup>
		OP844W	2.0			mA	VCE = 5.0 V, Eg = 5.0 mW/cm <sup>2(4)</sup>
		OP845W	2.5			mA	VCE = 5.0 V, Eg = 5.0 mW/cm <sup>2(4)</sup>
ICED	Collector Dark Current			100	nA	VCE = 10.0 V, Eg = 0	
V(BR)ICEO	Collector-Emitter Breakdown Voltage	30			V	IC = 100 μA	
V(BR)ECO	Emitter-Collector Breakdown Voltage	5.0			V	IE = 100 μA	
VCE(SAT) <sup>(3)</sup>	Collector-Emitter Saturation Voltage			0.40	V	IC = 0.40 mA, Eg = 5.0 mW/cm <sup>2(4)</sup>	
tr	Rise Time		2.0		μs	VCC = 5.0 V, IC = 0.80 mA	
tf	Fall Time		2.0		μs	RL = 100Ω, See Test Circuit	



Typical Performance Curves

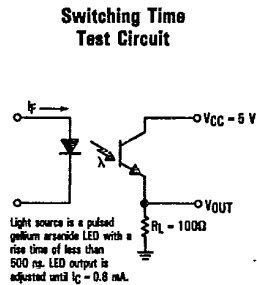
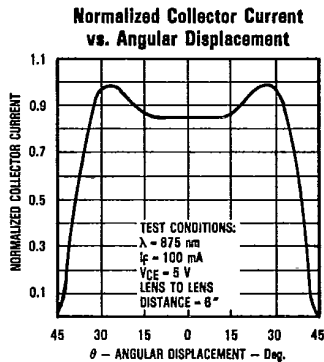
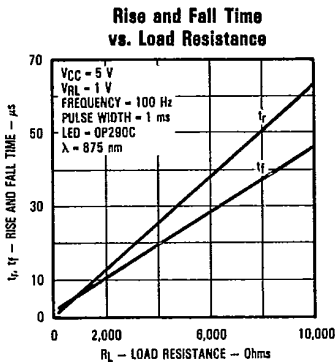
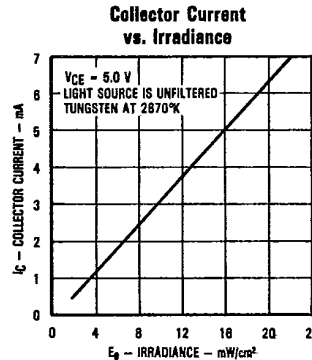
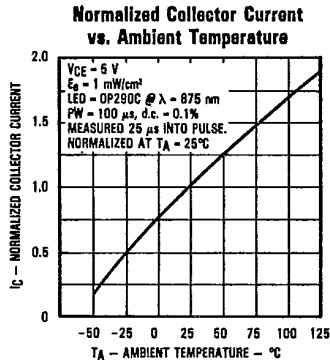
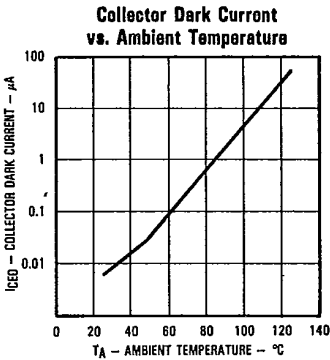

TRW reserves the right to make changes at any time in order to improve design and to supply the best product possible.

Optoelectronics Division, TRW Electronic Components Group, 1215 W. Crosby Rd., Carrollton, TX 75006 (214) 323-2200, TLX 6716032 or 215849 © TRW Inc. 1985, 1982. TRW is the name and mark of TRW Inc. Printed in U.S.A.