

6 Channel EMI Filter Array with ESD Protection

Features

- Six channels of EMI filtering for data ports
- Pi-style EMI filters in a capacitor-resistor-capacitor (C-R-C) network
- $\pm 30\text{kV}$ ESD protection on each channel (IEC 61000-4-2 Level 4, contact discharge)
- $\pm 30\text{kV}$ ESD protection on each channel (HBM)
- Greater than 35dB attenuation (typical) at 1 GHz
- 15-bump, 0.4mm pitch, 2.360mm x 1.053mm footprint Chip Scale Package (CSP)
- Chip Scale Package features extremely low lead inductance for optimum filter and ESD performance
- *OptiGuard*TM coated for improved reliability at assembly
- Lead-free version available

Applications

- LCD and Camera data lines in mobile handsets
- I/O port protection for mobile handsets, notebook computers, PDAs etc.
- EMI filtering for data ports in cell phones, PDAs or notebook computers.
- Wireless handsets
- Handheld PCs/PDAs
- LCD and camera modules

Product Description

The CM1440 is a six channel low-pass EMI filter array with ESD protection that reduces EMI/RFI emissions while providing robust protection from ESD strikes. Each EMI filter channel integrates a high quality pi-style filter (30pF-100 Ω -30pF) which provides greater than 30dB of attenuation in the 800MHz to 2.7GHz frequency range. The parts include avalanche-type ESD diodes on every pin, which provide a very high level of protection for sensitive electronic components that may be subjected to electrostatic discharge (ESD). The ESD protection diodes connected to the filter ports safely dissipate ESD strikes of $\pm 30\text{kV}$, beyond the maximum requirement of the IEC61000-4-2 international standard. Using the MIL-STD-883 (Method 3015) specification for Human Body Model (HBM) ESD, the pins are protected for contact discharges at greater than $\pm 30\text{kV}$.

This device is particularly well-suited for portable electronics (e.g. wireless handsets, PDAs, notebook computers) because of its small package and easy-to-use pin assignments. In particular, the CM1440 is ideal for EMI filtering and protecting data and control lines for the I/O data ports, LCD display and camera interface in mobile handsets.

The CM1440 incorporates *OptiGuard*TM which results in improved reliability at assembly. The CM1440 is available in a space saving, low profile Chip Scale Package with optional lead-free finishing. It is manufactured with a 0.40mm pitch and 0.25mm CSP solder ball to provide up to 28% board space savings versus competing CSP devices with 0.50mm pitch and 0.30mm CSP solder ball.

Electrical Schematic

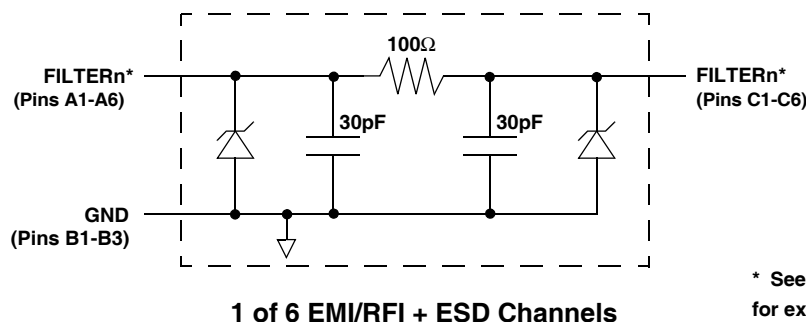

* See Package/Pinout Diagram for expanded pin information.

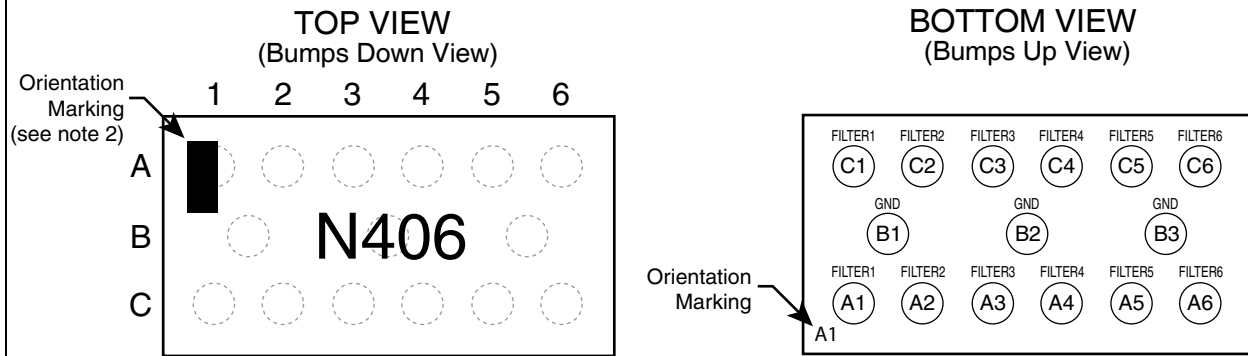
PACKAGE / PINOUT DIAGRAMS

CM1440-06CS/CP
15 Bump CSP Package

Notes:

- 1) These drawings are not to scale.
- 2) Lead-free devices are specified by using a "+" character for the top side orientation mark.

PIN DESCRIPTIONS

PIN(s)	NAME	DESCRIPTION
A1	FILTER1	Filter Channel 1
A2	FILTER2	Filter Channel 2
A3	FILTER3	Filter Channel 3
A4	FILTER4	Filter Channel 4
A5	FILTER5	Filter Channel 5
A6	FILTER6	Filter Channel 6
B1-B3	GND	Device Ground
C1	FILTER1	Filter Channel 1
C2	FILTER2	Filter Channel 2
C3	FILTER3	Filter Channel 3
C4	FILTER4	Filter Channel 4
C5	FILTER5	Filter Channel 5
C6	FILTER6	Filter Channel 6

Ordering Information
PART NUMBERING INFORMATION

Pins	Package	Standard Finish		Lead-free Finish ²	
		Ordering Part Number ¹	Part Marking	Ordering Part Number ¹	Part Marking
15	CSP	CM1440-06CS	N406	CM1440-06CP	N406

Note 1: Parts are shipped in Tape & Reel form unless otherwise specified.

Note 2: Lead-free devices are specified by using a "+" character for the top side orientation mark.

Specifications

ABSOLUTE MAXIMUM RATINGS

PARAMETER	RATING	UNITS
Storage Temperature Range	-65 to +150	°C
DC Power per Resistor	100	mW
DC Package Power Rating	500	mW

STANDARD OPERATING CONDITIONS

PARAMETER	RATING	UNITS
Operating Temperature Range	-40 to +85	°C

ELECTRICAL OPERATING CHARACTERISTICS (SEE NOTE1)

SYMBOL	PARAMETER	CONDITIONS	MIN	TYP	MAX	UNITS
R	Resistance		80	100	120	Ω
C _{TOTAL}	Total Channel Capacitance	At 2.5VDC Reverse Bias, 1MHz, 30mVAC	48	60	72	pF
C	Capacitance C1	At 2.5VDC Reverse Bias, 1MHz, 30mVAC	24	30	36	pF
V _{DIODE}	Standoff Voltage	I _{DIODE} =10μA		6.0		V
I _{LEAK}	Diode Leakage Current (reverse bias)	V _{DIODE} =+3.3V		0.1	1	μA
V _{SIG}	Signal Clamp Voltage Positive Clamp Negative Clamp	I _{LOAD} = 10mA	5.6 -1.5	6.8 -0.8	9.0 -0.4	V V
V _{ESD}	In-system ESD Withstand Voltage a) Human Body Model, MIL-STD-883, Method 3015 b) Contact Discharge per IEC 61000-4-2 Level 4	Notes 2 and 3	±30 ±30			kV kV
R _{DYN}	Dynamic Resistance Positive Negative			2.3 0.9		Ω Ω
f _C	Cut-off Frequency Z _{SOURCE} =50Ω, Z _{LOAD} =50Ω	R=100Ω, C=30pF		60		MHz

Note 1: T_A=25°C unless otherwise specified.

Note 2: ESD applied to input and output pins with respect to GND, one at a time.

Note 3: These parameters are guaranteed by design and characterization.

Performance Information

Typical Filter Performance (T_A=25°C, DC Bias=0V, 50 Ohm Environment)

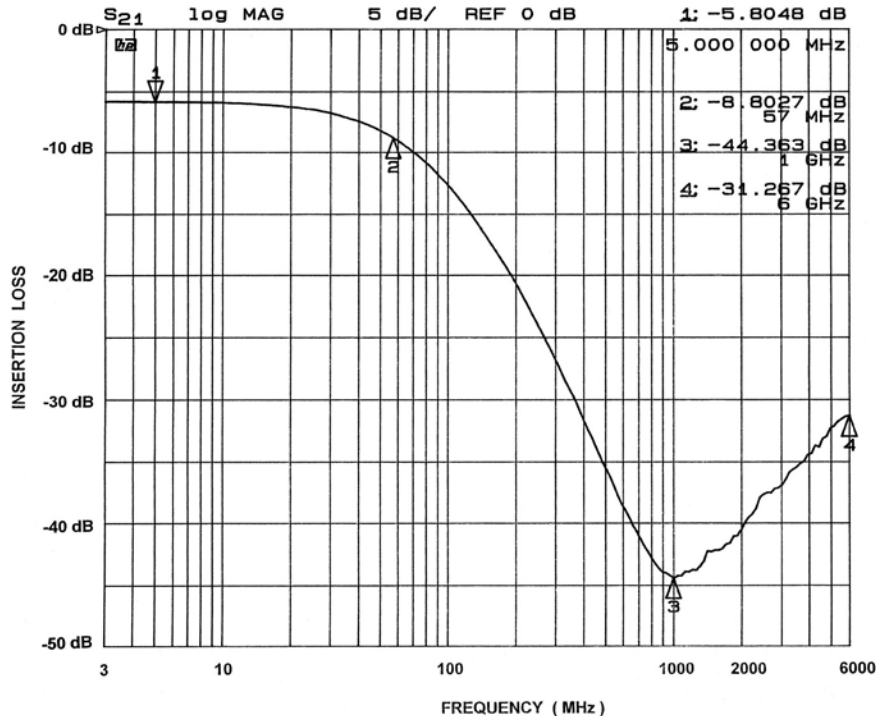

Figure 1. Insertion Loss vs. Frequency (A1-C1 to GND B1)

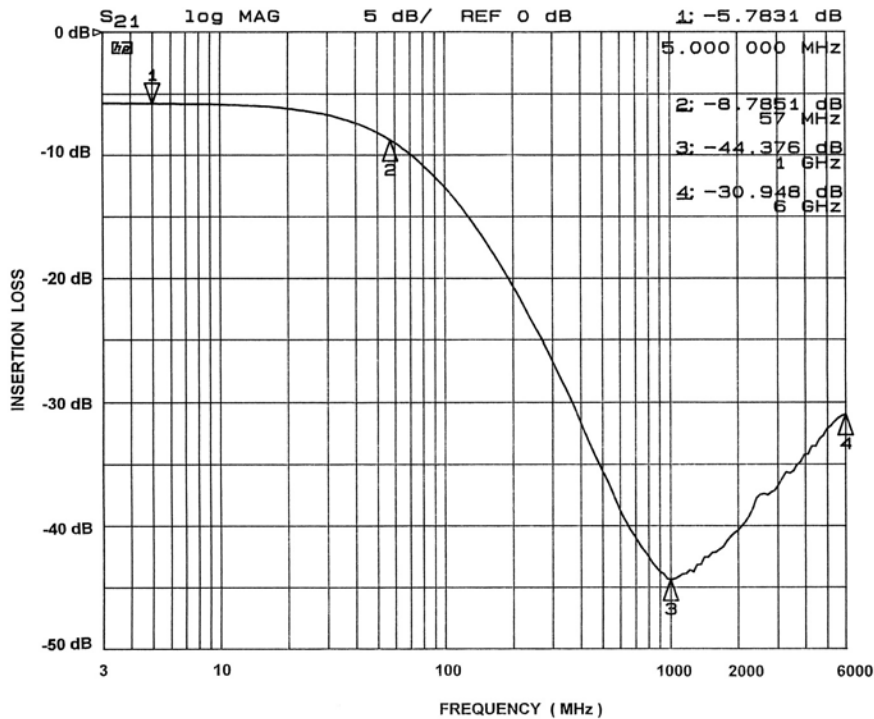

Figure 2. Insertion Loss vs. Frequency (A2-C2 to GND B1)

Performance Information (cont'd)

Typical Filter Performance ($T_A=25^\circ\text{C}$, DC Bias=0V, 50 Ohm Environment)



Figure 3. Insertion Loss vs. Frequency (A3-C3 to GND B2)

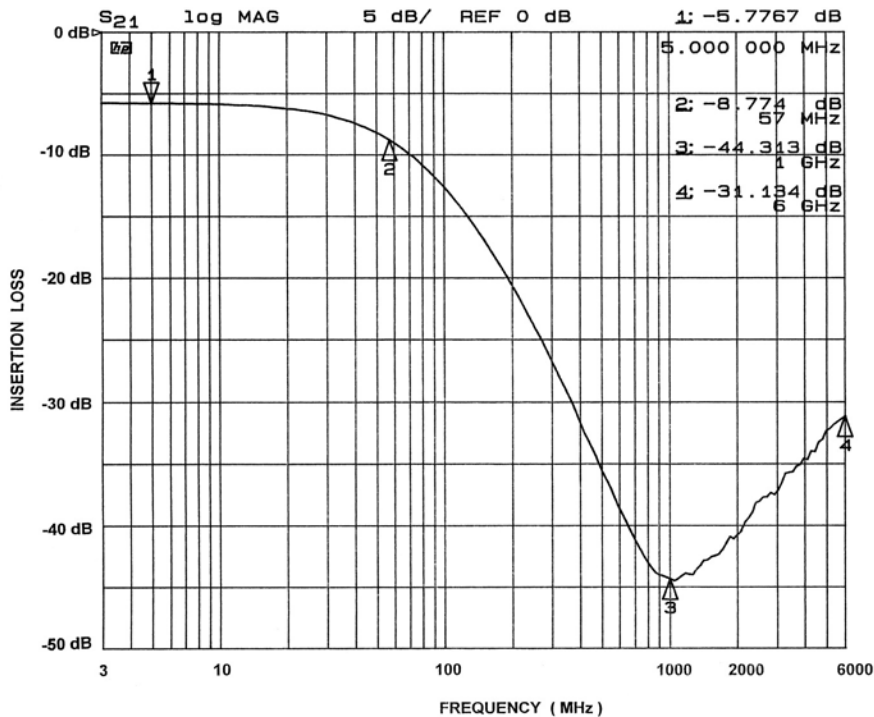

Figure 4. Insertion Loss vs. Frequency (A4-C4 to GND B2)

Performance Information (cont'd)

Typical Filter Performance ($T_A=25^\circ\text{C}$, DC Bias=0V, 50 Ohm Environment)

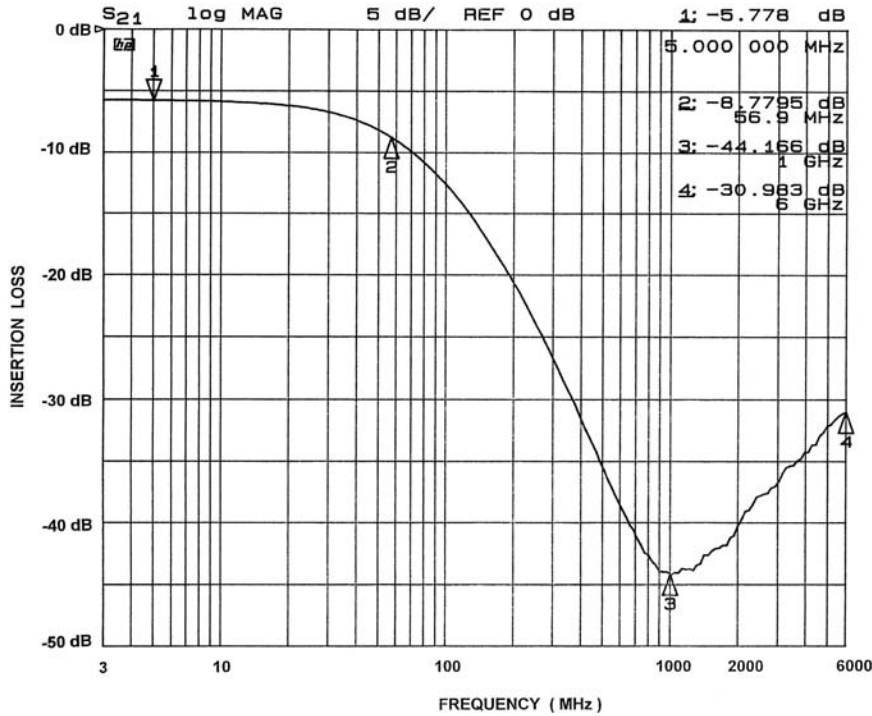

Figure 5. Insertion Loss vs. Frequency (A5-C5 to GND B3)

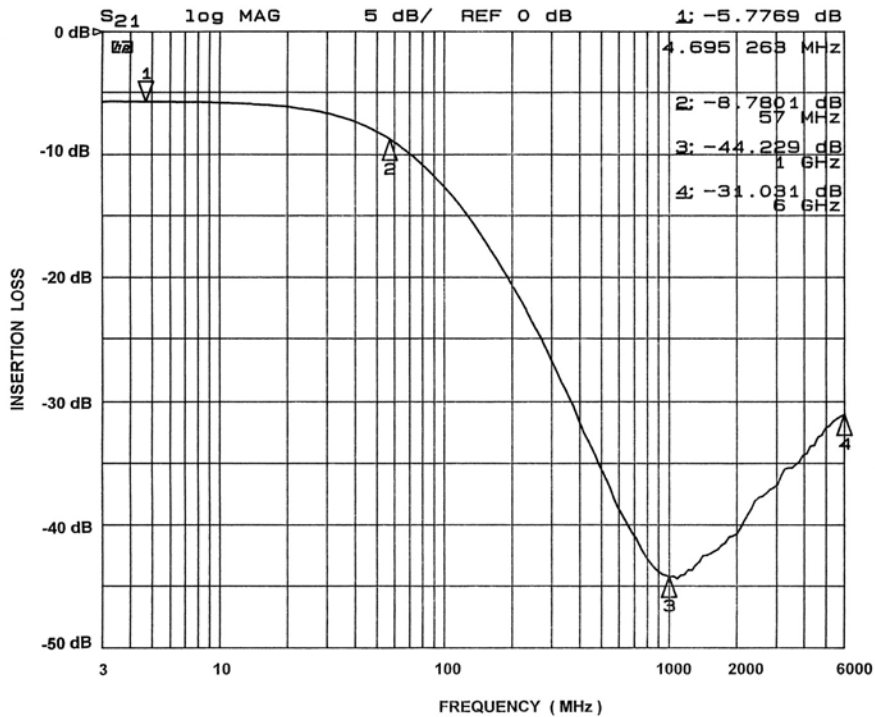
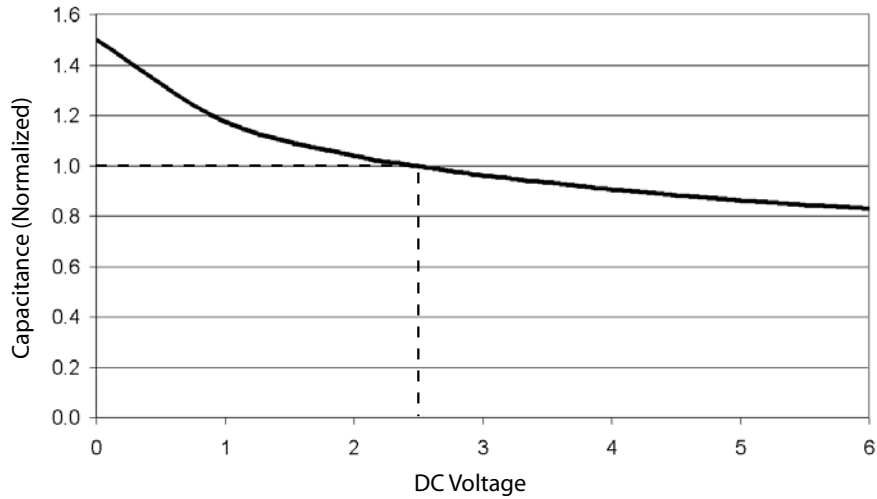

Figure 6. Insertion Loss vs. Frequency (A6-C6 to GND B3)

Performance Information (cont'd)

Typical Diode Capacitance vs. Input Voltage



**Figure 7. Filter Capacitance vs. Input Voltage
(normalized to capacitance at 2.5VDC and 25°C)**

Application Information

Refer to Application Note AP-217, "The Chip Scale Package", for a detailed description of Chip Scale Packages offered by California Micro Devices.

PRINTED CIRCUIT BOARD RECOMMENDATIONS	
PARAMETER	VALUE
Pad Size on PCB	0.240mm
Pad Shape	Round
Pad Definition	Non-Solder Mask defined pads
Solder Mask Opening	0.290mm Round
Solder Stencil Thickness	0.125mm - 0.150mm
Solder Stencil Aperture Opening (laser cut, 5% tapered walls)	0.300mm Round
Solder Flux Ratio	50/50 by volume
Solder Paste Type	No Clean
Pad Protective Finish	OSP (Entek Cu Plus 106A)
Tolerance — Edge To Corner Ball	±50µm
Solder Ball Side Coplanarity	±20µm
Maximum Dwell Time Above Liquidous (183°C)	60 seconds
Maximum Soldering Temperature for a Eutectic Device using Eutectic Solder Paste	240°C
Maximum Soldering Temperature for a Lead-free Device using Lead-free Solder Paste	260°C

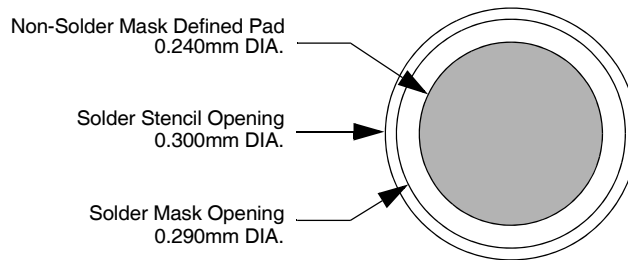

Figure 8. Recommended Non-Solder Mask Defined Pad Illustration

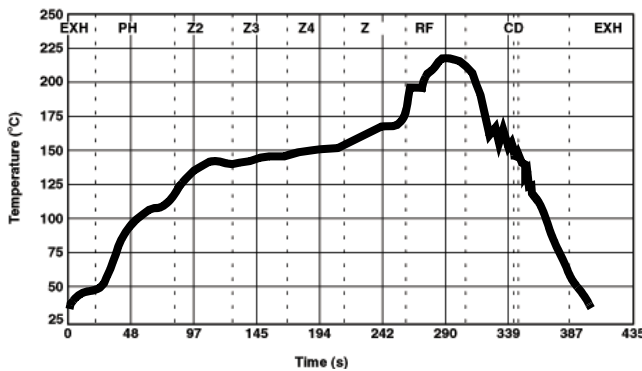

Figure 9. Eutectic (SnPb) Solder Ball Reflow Profile

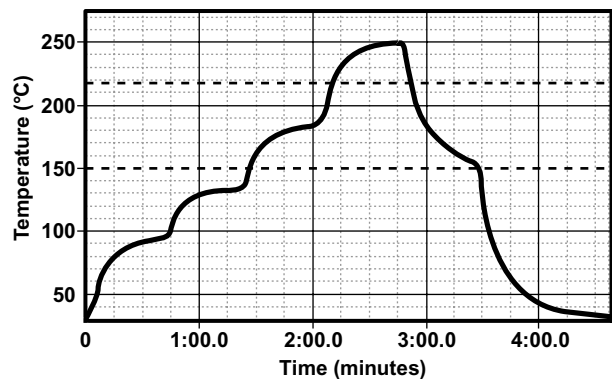

Figure 10. Lead-free (SnAgCu) Solder Ball Reflow Profile

Mechanical Details

CSP Mechanical Specifications

CM1440 devices are supplied in a custom Chip Scale Package (CSP). Dimensions are presented below. For complete information on CSP packaging, see the California Micro Devices CSP Package Information document.

PACKAGE DIMENSIONS						
Package	Custom CSP					
Bumps	15					
Dim	Millimeters			Inches		
	Min	Nom	Max	Min	Nom	Max
A1	2.3150	2.3600	2.4050	0.911	0.0929	0.0947
A2	1.008	1.053	1.098	0.0397	0.0415	0.0432
B1	0.395	0.4000	0.405	0.0156	0.0157	0.0159
B2	0.195	0.2000	0.205	0.0076	0.0078	0.0080
B3	0.3415	0.3465	0.3515	0.0134	0.0136	0.0138
B4	0.3415	0.3465	0.3515	0.0134	0.0136	0.0138
C1	0.130	0.1800	0.230	0.0051	0.0071	0.0091
C2	0.130	0.1800	0.230	0.0051	0.0071	0.0091
D1	0.575	0.644	0.714	0.0226	0.0254	0.0281
D2	0.368	0.419	0.470	0.0145	0.0165	0.0185
# per tape and reel	3500 pieces					
Controlling dimension: millimeters						

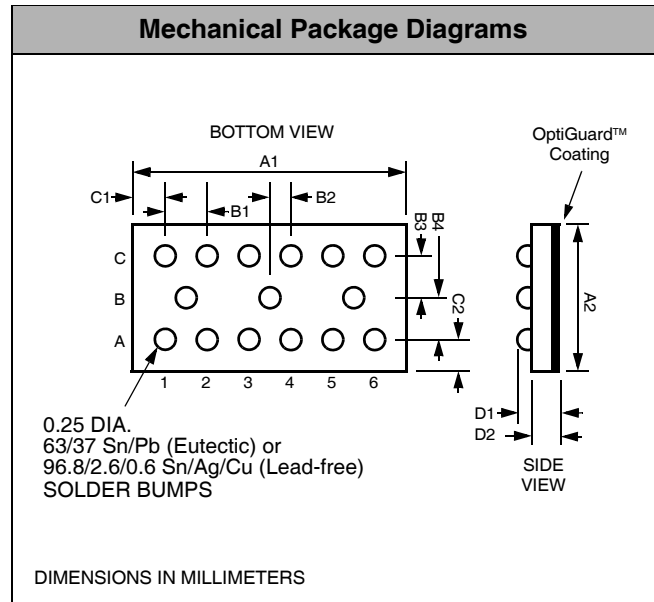

Package Dimensions for CM1440 Chip Scale Package

CSP Tape and Reel Specifications

PART NUMBER	CHIP SIZE (mm)	POCKET SIZE (mm) $B_0 \times A_0 \times K_0$	TAPE WIDTH W	REEL DIAMETER	QTY PER REEL	P_0	P_1
CM1440	2.36 X 1.053 X 0.644	2.62 X 1.12 X 0.76	8mm	178mm (7")	3500	4mm	4mm

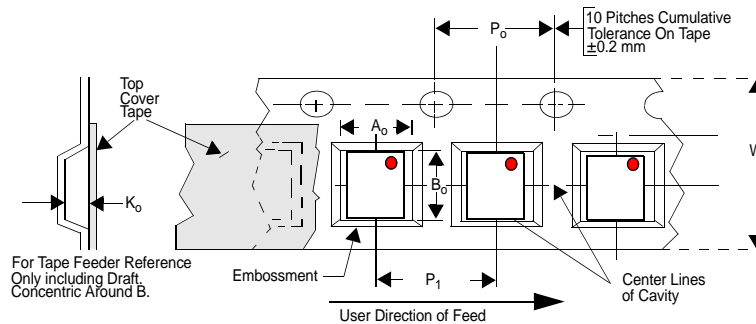

Figure 11. Tape and Reel Mechanical Data