

LED Driver

- Supplies stable bias current even at low battery voltage
- Low voltage drop of 0.75V
- Ideal for stabilizing bias current of LEDs
- Negative temperature coefficient protects LEDs against thermal overload

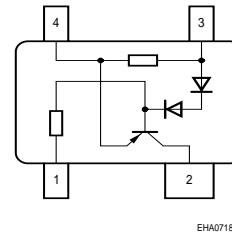
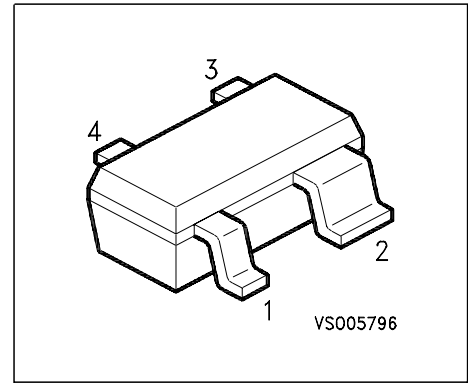

Type	Marking	Pin Configuration				Package
BCR401R	W5s	1 = GND	2 = I _{out}	3 = V _S	4 = R _{ext}	SOT143R

Maximum Ratings

Parameter	Symbol	Value	Unit
Source voltage	V _S	18	V
Output current	I _{out}	60	mA
Output voltage	V _{out}	16	V
Reverse voltage between all terminals	V _R	0.5	
Total power dissipation, T _S = 87 °C	P _{tot}	330	mW
Junction temperature	T _j	150	°C
Storage temperature	T _{stg}	-65 ... 150	

Thermal Resistance

Parameter	Symbol	Value	Unit
Junction - soldering point ¹⁾	R _{thJS}	190	K/W

¹⁾For calculation of R_{thJA} please refer to Application Note Thermal Resistance

Electrical Characteristics at $T_A=25^\circ\text{C}$, unless otherwise specified

Parameter	Symbol	Values			Unit
		min.	typ.	max.	
Characteristics					
Supply current $V_S = 10\text{ V}$	I_S	350	440	540	μA
Output current $V_S = 10\text{ V}, V_{\text{out}} = 7.6\text{ V}$	I_{out}	9	10	11	mA

DC Characteristics with stabilized LED load

Lowest sufficient battery voltage overhead $I_{\text{out}} > 8\text{ mA}$	$V_{S\text{min}}$	-	1.2	-	V
Voltage drop ($V_S - V_{\text{CE}}$) $I_{\text{out}} = 20\text{ mA}$	V_{drop}	-	0.75	-	
Output current change versus T_A $V_S = 10\text{ V}$	$\Delta I_{\text{out}}/I_{\text{out}}$	-	-0.3	-	%/K
Output current change versus V_S $V_S = 10\text{ V}$	$\Delta I_{\text{out}}/I_{\text{out}}$	-	2	-	%/V

Total power dissipation $P_{tot} = f(T_S)$

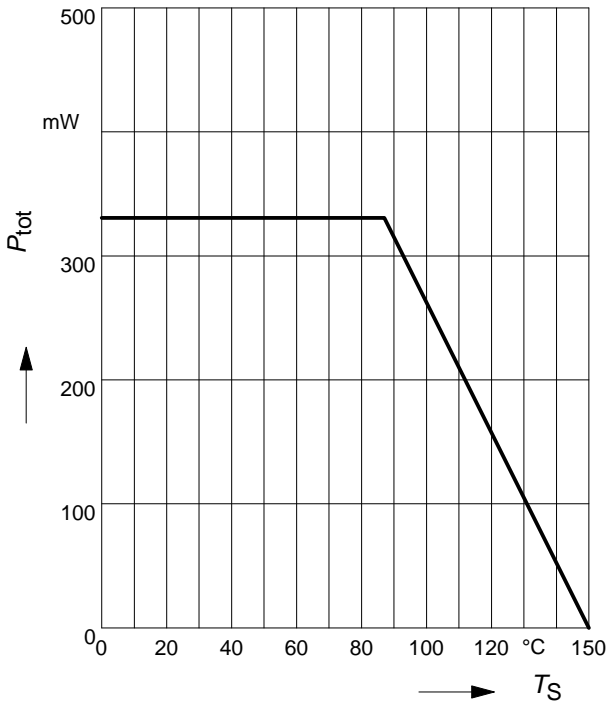

Output current versus supply voltage

$I_{out} = f(V_S); R_{ext} = \text{Parameter}$

Load: two LEDs with $V_F = 3.8V$ in series

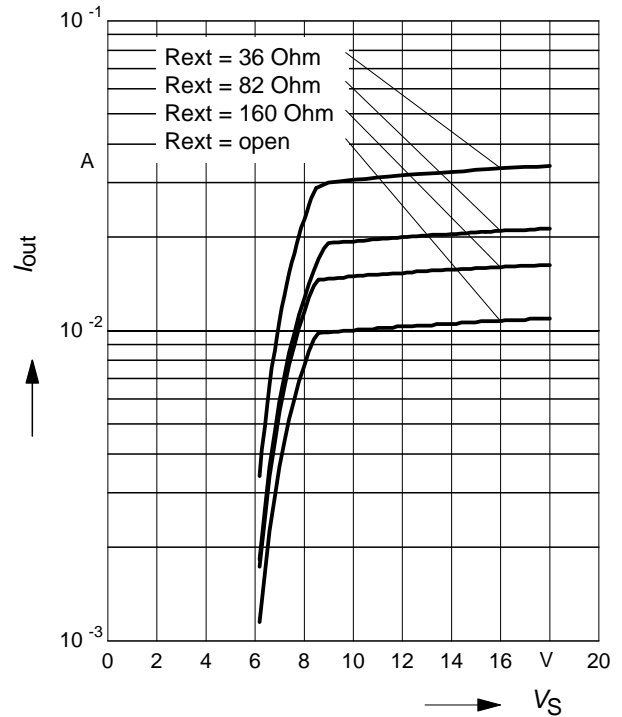

Supply current versus supply voltage

$I_S = f(V_S)$

Load: two LEDs with $V_F = 3.8V$ in series

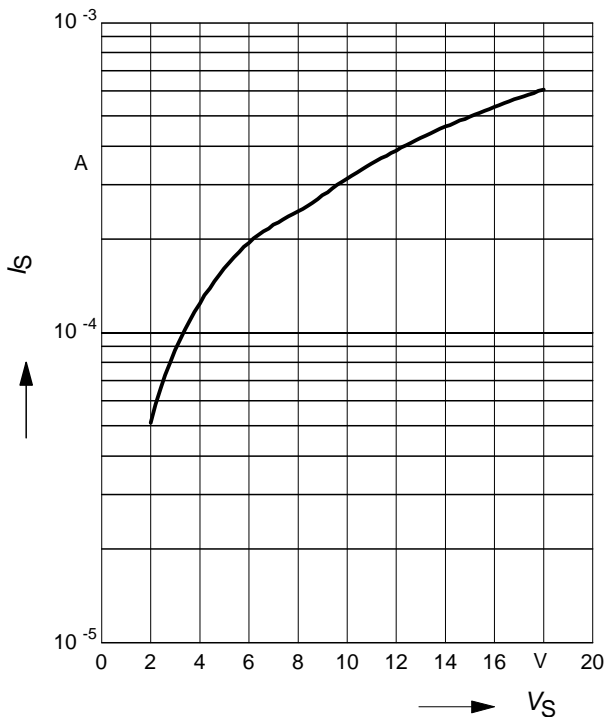

Application Circuit:

