

NPN Planer RF TRANSISTOR

DESCRIPTION

The THN3101Z is a low Noise figure and good associated gain performance at Microwave frequencies

It is suitable for a high density surface mount since transistor has been SOT343 package

FEATURES

- o Low Noise Figure
N.F = 1.1dB TYP. @ f=1.8GHz, $V_{CE}=2V$, $I_c=3mA$
- o High Gain
MSG = 21dB TYP. @ f=1.8GHz, $V_{CE}=2V$, $I_c=5mA$
- o High Transition Frequency
 $f_T = 25GHz$ TYP. @ f=1.8GHz, $V_{CE}=3V$, $I_c=10mA$

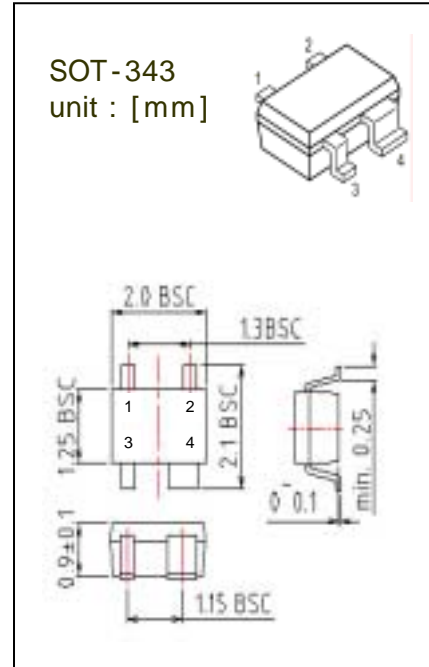

PIN CONFIGURATION

PIN NO	SYMBOL	DESCRIPTION
1	E	Emitter
2	C	Collector
3	B	Base
4	E	Emitter

MARKING : BA1

MAXIMUM RATINGS

SYMBOL	PARAMETER	CONDITION	VALUE	Unit
V_{CBO}	Collector-Base Voltage	Open Emitter	12	V
V_{CEO}	Collector-Emitter Voltage	Open Base	5	V
V_{EBO}	Emitter-Base Voltage	Open Collector	2.5	V
I_c	Collector Current (DC)		15	mA
P_T	Total Power Dissipation	$T_s \leq 100$	55	mW
T_{STG}	Storage Temperature		-65 ~ 150	
T_J	Operating Junction Temperature		150	

Electrical Characteristics ($T_A = 25$)

SYMBOL	PARAMETER	CONDITION	VALUE			Unit
			min	typ	max	
V _{CBO}	Collector-Base Voltage	I _{CE} = 100uA, I _E = 0	7	12		V
V _{CEO}	Collector-Emitter Voltage	I _{CE} = 100uA, I _B = 0	4.5	5		V
I _{CBO}	Collector-Cut-off current	V _{CB} = 7V, I _E = 0			300	n A
I _{EBO}	Emitter-Cut-off current	V _{EB} = 1V, I _C = 0			100	n A
h _{fe}	D.C current Gain	V _{CE} = 2V, I _C = 10mA	200	300	400	
f _T	Transition Frequency	V _{CE} = 3V, I _C = 10mA		25		GHz
C _{CB}	Collector-Base Capacitance	V _{CB} = 2V, f = 1MHz		0.06		pF

Performance Characteristics

SYMBOL	PARAMETER	CONDITION	VALUE			Unit
			min	typ	max	
[S ₂₁] ²	Insertion Power Gain	V _{CE} = 2V @ f = 1.8 GHz I _C =5mA, (Z _s = Z _L = 50)		18		dB
		I _C =15mA, (Z _s = Z _L = 50)		19		
MSG	Maximum Stable Gain	I _C =5mA, (Z _s =Z _{sopt} , Z _L =Z _{Lopt})		21		dB
		I _C =15mA, (Z _s =Z _{sopt} , Z _L =Z _{Lopt})		22		
NF _{min}	Minimum Noise Figure	I _C =3mA, (Z _s = Z _{sopt})		1.1		dB
rn	Noise Resistance	I _C =3mA, (Z _s = Z _{sopt})		0.37		
G _A	Associated Gain	I _C =3mA, (Z _s = Z _{sopt})		16.5		dB
		I _C =10mA, (Z _s = Z _{sopt})		18		
P _{-1dB}	1dB Compression point	I _C =5mA, (Z _s =Z _{sopt} , Z _L =Z _{Lopt})		5		dBm
OIP ₃	Third order intercept point	I _C =5mA, (Z _s =Z _{sopt} , Z _L =Z _{Lopt})		15		dBm

SPICE Parameters (Gummel-Poon Model)
Transistor Chip Data

IS	= 2.872E-17 A	BF	= 445	NF	= 1
VAF	= 98.4 V	IKF	= 0.12 A	ISE	= 9.8E-17 A
Ne	= 1.442	BR	= 8.78	NR	= 0.879
VAR	= 2.91 V	IKR	= 0.036 A	ISC	= 7.8E-18 A
NC	= 1.098	RB	= 19.5 Ω	IRB	= 1.39E-5 A
RBM	= 6.9 Ω	RE	= 0.78 Ω	RC	= 2.98 Ω
CJE	= 2.363E-13 F	VJE	= 0.879 V	MJE	= 0.298
CJC	= 0.988E-13 F	VJC	= 0.519 V	MJC	= 0.0893
XCJC	= 0.46	CJS	= -	VJS	= 0.75 V
MJS	= -	FC	= 0.91	XTF	= 8.9
TF	= 3.979E-12 sec.	VTF	= 1.5145 V	ITF	= 0.1009 A
PTF	= 15.953	TR	= 1.1e-12 sec.	NK	= 0.5
EG	= 1.11 eV	XTB	= 1	XTI	= 3

Package Equivalent Circuit:

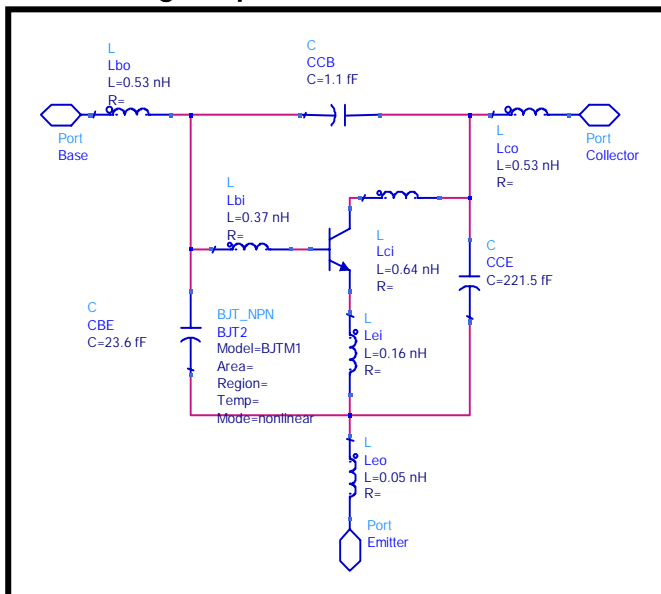

C_{CB}	1.1 fF
C_{BE}	23.6 fF
C_{CE}	221.5 fF
L_{CI}	0.64 nH
L_{CO}	0.53 nH
L_{BI}	0.37 nH
L_{BO}	0.53 nH
L_{EI}	0.16 nH
L_{EO}	0.05 nH

To avoid high complexity of the package equivalent circuit, both leads are combined in one electrical connection. The SOT-343 package has two emitter leads.

Total power dissipation $P_t = f(T_A)$

($T_A = 25$)

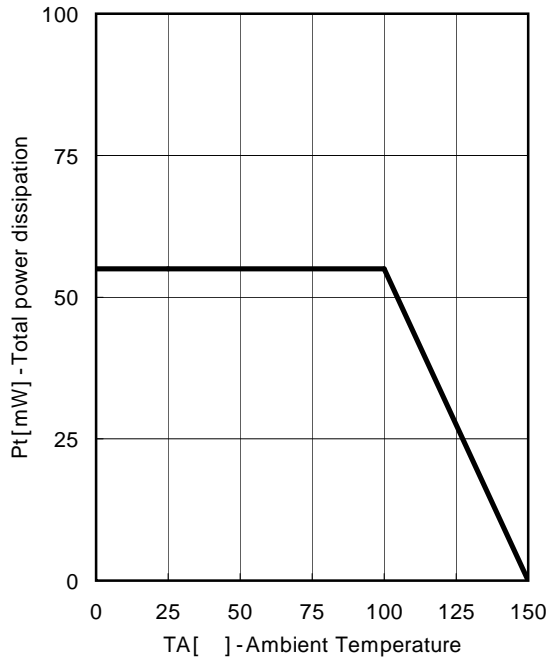

ICE vs. VCE

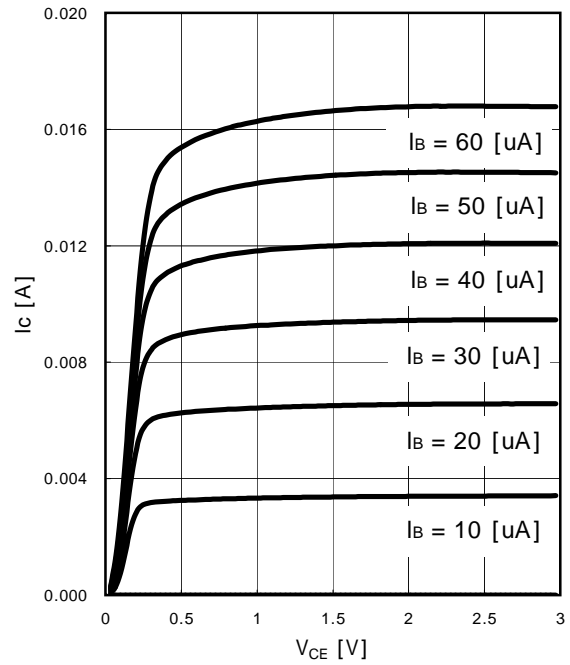

Icc vs. VBE

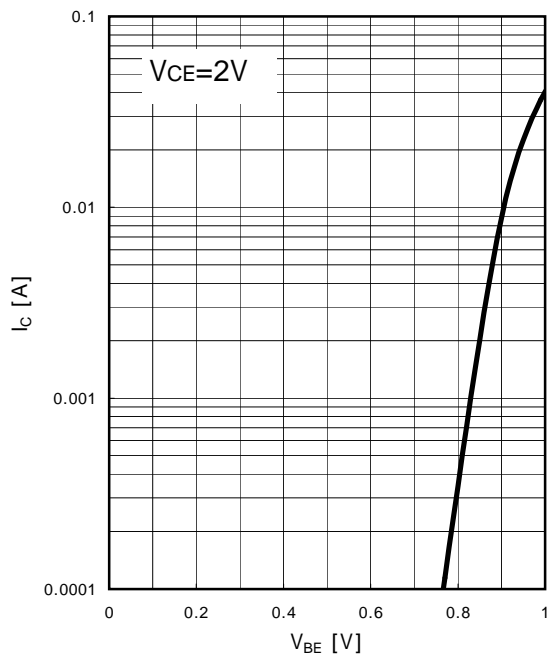

hfe vs. Icc

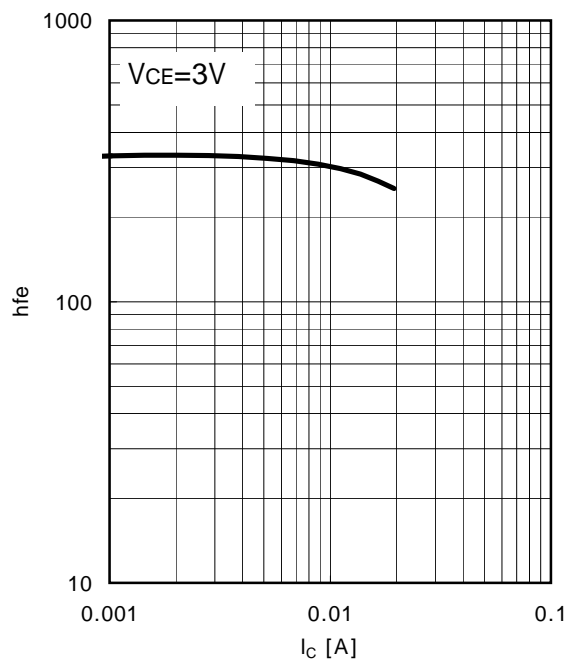

Power Gain : MSG, MAG, $[S_{21}]^2 = f(\text{freq})$

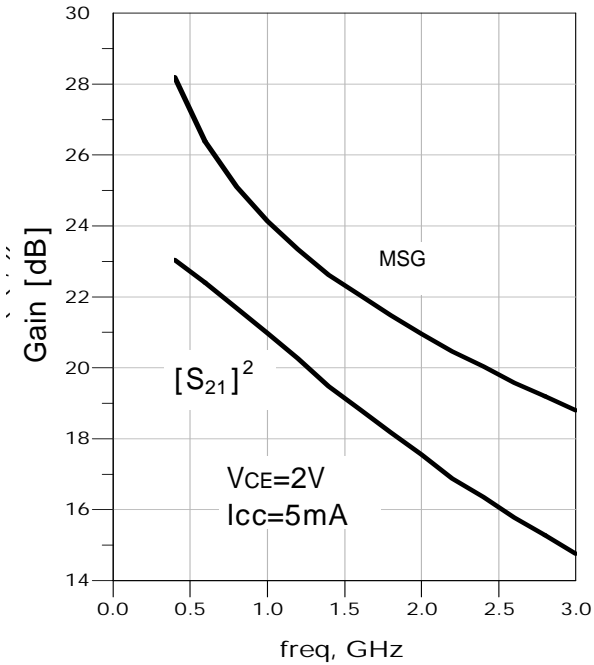

Power Gain : MSG, MAG, $[S_{21}]^2 = f(\text{freq})$

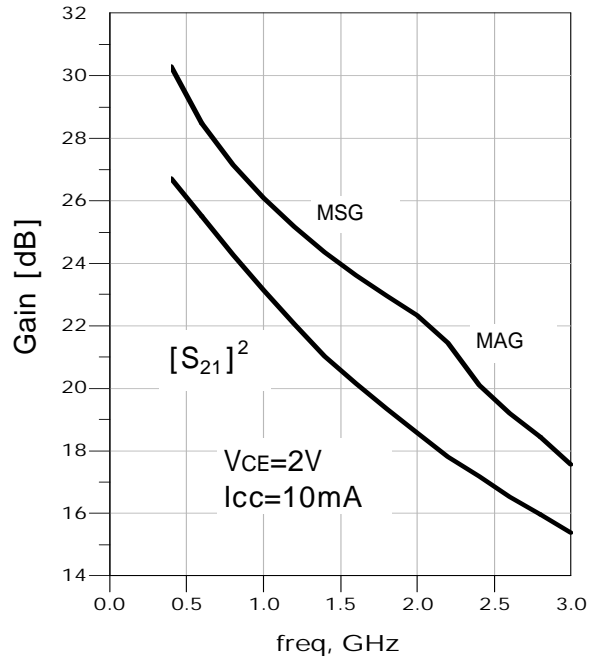

Power Gain : MSG, MAG, $[S_{21}]^2 = f(\text{freq})$

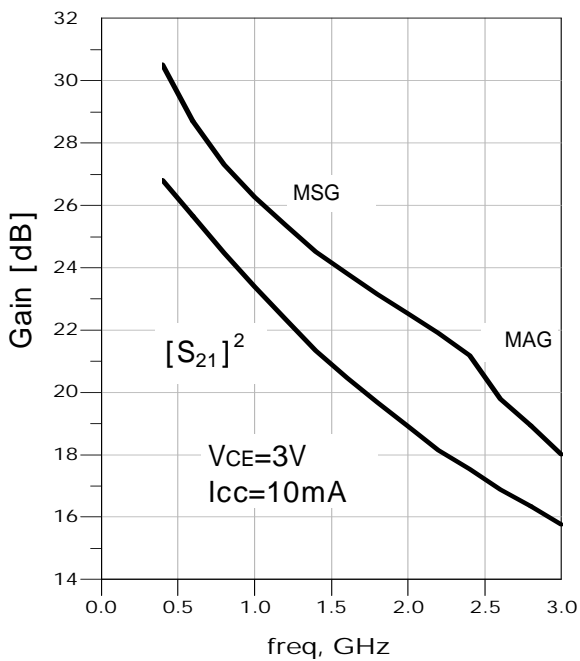

Power Gain : MAG, MSG = f(I_{CE})

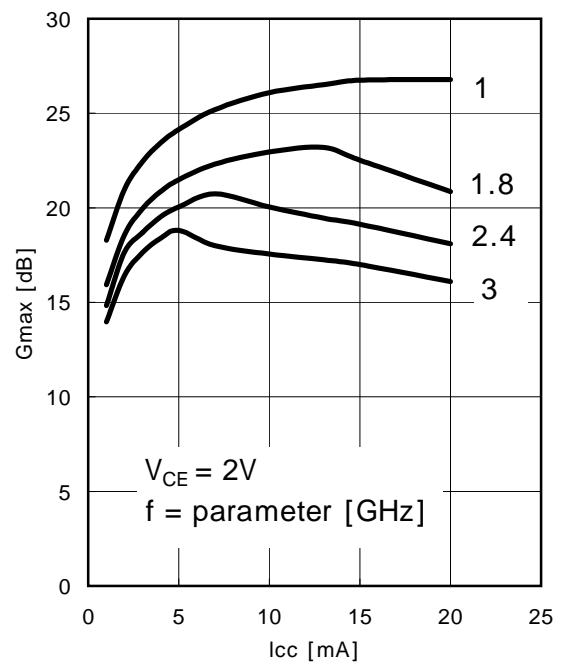

Transition Frequency : f_T vs. I_{CC}

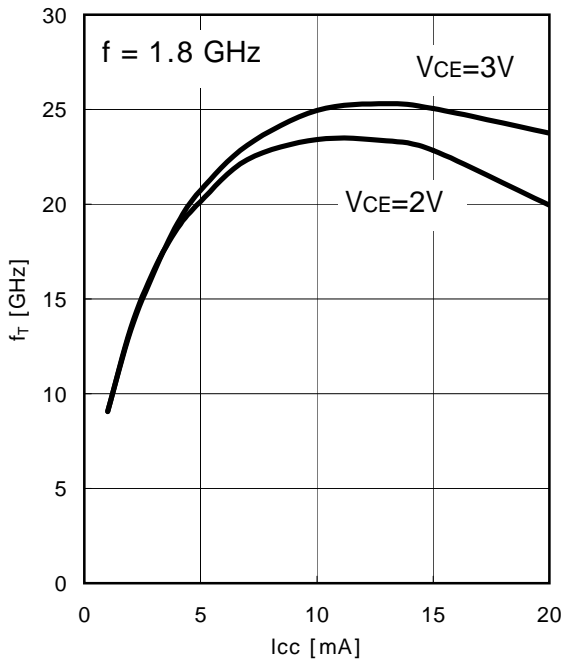

C_{CB} vs. V_{CB}

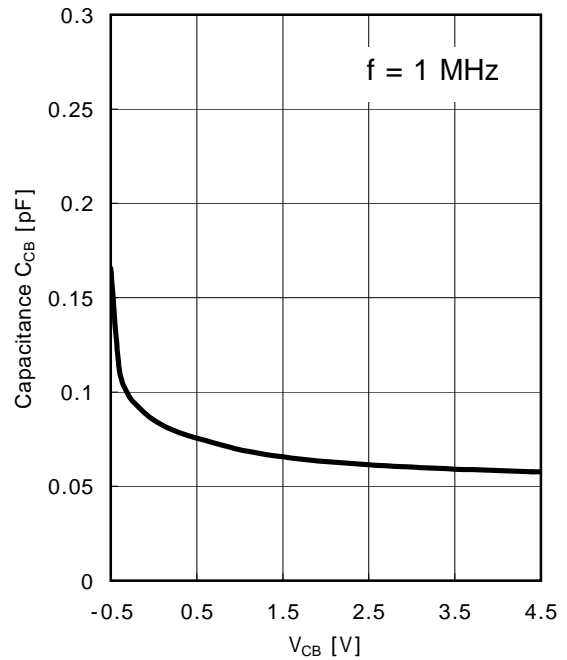

F_{min} vs. I_{CC}

$V_{CE} = 2V$, $I_{CC} = \text{parameter}$, $Z_s = Z_{opt}$

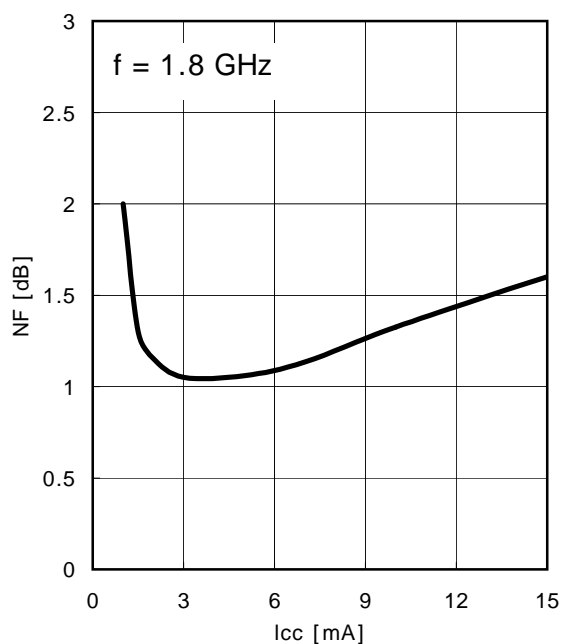

Noise Figure Contours & Constant Gain

$f = 1.8 \text{ GHz}$, $V_{CE} = 2V$, $I_{CC} = 3mA$

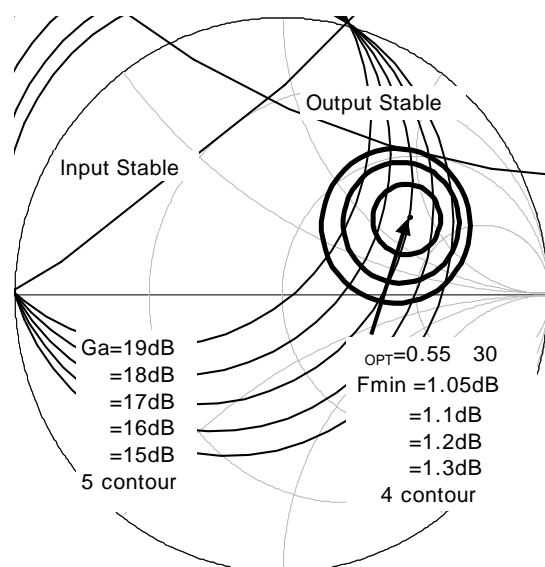

Common Emitter S-Parameter Data
VCE = 2V, ICC = 2mA

freq	S(1,1)	S(2,1)	S(1,2)	S(2,2)
400.0MHz	0.946 / -20.412	6.968 / 161.493	0.023 / 76.540	0.979 / -11.226
600.0MHz	0.907 / -29.460	6.732 / 154.230	0.033 / 70.896	0.945 / -15.622
800.0MHz	0.870 / -38.099	6.506 / 146.596	0.042 / 65.027	0.918 / -20.384
1.000GHz	0.841 / -47.108	6.296 / 139.075	0.051 / 59.764	0.885 / -24.487
1.200GHz	0.813 / -55.029	6.069 / 132.793	0.058 / 54.731	0.851 / -27.878
1.400GHz	0.770 / -62.220	5.782 / 127.151	0.064 / 50.693	0.817 / -30.933
1.600GHz	0.734 / -69.746	5.563 / 120.591	0.070 / 46.667	0.784 / -34.442
1.800GHz	0.700 / -77.521	5.353 / 115.231	0.075 / 43.096	0.755 / -37.147
2.000GHz	0.670 / -84.576	5.118 / 109.074	0.079 / 39.132	0.725 / -40.747
2.200GHz	0.633 / -92.480	4.868 / 103.538	0.083 / 35.741	0.697 / -43.618
2.400GHz	0.595 / -101.171	4.698 / 98.078	0.086 / 32.408	0.671 / -46.372
2.600GHz	0.568 / -108.676	4.477 / 92.788	0.089 / 29.421	0.646 / -49.228
2.800GHz	0.545 / -116.866	4.292 / 87.959	0.092 / 26.236	0.624 / -52.111
3.000GHz	0.511 / -124.692	4.115 / 82.520	0.094 / 23.132	0.597 / -54.678

VCE = 2V, ICC = 3mA

freq	S(1,1)	S(2,1)	S(1,2)	S(2,2)
400.0MHz	0.909 / -24.398	9.729 / 158.499	0.022 / 74.989	0.968 / -13.195
600.0MHz	0.865 / -34.599	9.307 / 150.060	0.032 / 68.339	0.924 / -18.316
800.0MHz	0.818 / -45.057	8.821 / 141.405	0.041 / 62.079	0.885 / -23.557
1.000GHz	0.779 / -55.340	8.393 / 133.159	0.048 / 56.702	0.841 / -27.913
1.200GHz	0.744 / -63.582	7.938 / 126.532	0.054 / 51.973	0.796 / -31.258
1.400GHz	0.698 / -72.380	7.441 / 120.539	0.059 / 48.191	0.755 / -34.276
1.600GHz	0.658 / -80.429	7.043 / 113.867	0.063 / 44.381	0.716 / -37.553
1.800GHz	0.615 / -88.190	6.671 / 108.472	0.067 / 41.324	0.682 / -39.971
2.000GHz	0.586 / -95.889	6.293 / 102.421	0.071 / 38.050	0.650 / -43.262
2.200GHz	0.546 / -104.031	5.904 / 97.073	0.073 / 35.375	0.620 / -45.726
2.400GHz	0.510 / -112.557	5.633 / 91.860	0.076 / 32.639	0.594 / -48.128
2.600GHz	0.491 / -121.393	5.317 / 86.852	0.079 / 30.099	0.568 / -50.618
2.800GHz	0.470 / -129.278	5.065 / 82.149	0.081 / 27.733	0.547 / -53.177
3.000GHz	0.439 / -139.274	4.803 / 77.177	0.083 / 25.482	0.521 / -55.493

VCE = 2V, ICC = 4mA

freq	S(1,1)	S(2,1)	S(1,2)	S(2,2)
400.0MHz	0.893 / -27.030	12.177 / 155.808	0.022 / 73.183	0.956 / -14.957
600.0MHz	0.841 / -39.570	11.468 / 146.331	0.031 / 66.324	0.901 / -20.615
800.0MHz	0.781 / -50.963	10.698 / 136.983	0.039 / 59.876	0.852 / -26.102
1.000GHz	0.727 / -61.725	10.012 / 128.333	0.045 / 54.577	0.800 / -30.489
1.200GHz	0.693 / -70.848	9.316 / 121.499	0.050 / 50.332	0.747 / -33.655
1.400GHz	0.640 / -79.481	8.630 / 115.409	0.055 / 46.796	0.702 / -36.358
1.600GHz	0.595 / -88.192	8.058 / 108.826	0.058 / 43.534	0.661 / -39.347
1.800GHz	0.549 / -96.462	7.542 / 103.503	0.062 / 40.994	0.626 / -41.406
2.000GHz	0.521 / -104.965	7.065 / 97.602	0.064 / 38.257	0.593 / -44.355
2.200GHz	0.490 / -112.362	6.569 / 92.473	0.067 / 35.977	0.564 / -46.456
2.400GHz	0.454 / -122.244	6.222 / 87.535	0.069 / 33.891	0.539 / -48.545
2.600GHz	0.442 / -130.606	5.840 / 82.726	0.072 / 31.957	0.515 / -50.789
2.800GHz	0.425 / -138.237	5.531 / 78.203	0.074 / 29.865	0.496 / -53.069
3.000GHz	0.396 / -148.421	5.224 / 73.592	0.076 / 27.874	0.472 / -55.161

VCE = 2V, ICC = 5mA

freq	S(1,1)	S(2,1)	S(1,2)	S(2,2)
400.0MHz	0.867 / -30.673	14.201 / 153.374	0.021 / 72.571	0.943 / -16.425
600.0MHz	0.810 / -43.213	13.183 / 143.238	0.030 / 64.995	0.880 / -22.466
800.0MHz	0.743 / -55.775	12.132 / 133.418	0.037 / 58.232	0.822 / -28.033
1.000GHz	0.682 / -67.496	11.202 / 124.481	0.043 / 53.218	0.764 / -32.326
1.200GHz	0.637 / -77.200	10.300 / 117.615	0.048 / 49.009	0.708 / -35.199
1.400GHz	0.588 / -85.750	9.431 / 111.608	0.052 / 46.211	0.661 / -37.616
1.600GHz	0.545 / -94.044	8.728 / 105.115	0.055 / 43.396	0.619 / -40.282
1.800GHz	0.503 / -103.948	8.116 / 99.926	0.058 / 41.158	0.584 / -41.980
2.000GHz	0.479 / -110.931	7.548 / 94.190	0.060 / 38.807	0.553 / -44.657
2.200GHz	0.448 / -119.390	6.983 / 89.299	0.063 / 37.055	0.525 / -46.473
2.400GHz	0.416 / -128.939	6.579 / 84.508	0.065 / 35.363	0.502 / -48.323
2.600GHz	0.408 / -138.035	6.150 / 79.908	0.068 / 33.774	0.480 / -50.366
2.800GHz	0.391 / -145.971	5.815 / 75.516	0.070 / 31.920	0.461 / -52.512
3.000GHz	0.373 / -155.868	5.471 / 71.175	0.072 / 30.089	0.439 / -54.440

VCE = 2V, Icc = 7mA

freq	S(1,1)	S(2,1)	S(1,2)	S(2,2)
400.0MHz	0.826 / -37.010	17.914 / 148.865	0.021 / 70.137	0.916 / -19.101
600.0MHz	0.743 / -51.314	16.143 / 137.477	0.029 / 62.461	0.835 / -25.554
800.0MHz	0.669 / -65.187	14.455 / 127.077	0.035 / 55.919	0.764 / -31.003
1.000GHz	0.606 / -77.491	13.026 / 117.956	0.039 / 51.448	0.698 / -34.800
1.200GHz	0.554 / -87.716	11.730 / 111.252	0.043 / 48.315	0.639 / -36.906
1.400GHz	0.509 / -96.767	10.562 / 105.482	0.046 / 46.000	0.593 / -38.661
1.600GHz	0.470 / -105.704	9.654 / 99.244	0.049 / 44.229	0.553 / -40.643
1.800GHz	0.434 / -114.877	8.870 / 94.442	0.052 / 42.732	0.521 / -41.746
2.000GHz	0.409 / -123.214	8.175 / 89.031	0.054 / 41.220	0.493 / -43.912
2.200GHz	0.389 / -131.201	7.514 / 84.485	0.057 / 40.043	0.469 / -45.311
2.400GHz	0.368 / -141.309	7.034 / 80.047	0.059 / 38.723	0.449 / -46.787
2.600GHz	0.360 / -150.926	6.545 / 75.856	0.062 / 37.595	0.429 / -48.544
2.800GHz	0.357 / -158.215	6.162 / 71.758	0.064 / 36.094	0.414 / -50.457
3.000GHz	0.344 / -167.925	5.779 / 67.554	0.067 / 34.724	0.394 / -52.222

VCE = 2V, Icc = 10mA

freq	S(1,1)	S(2,1)	S(1,2)	S(2,2)
400.0MHz	0.750 / -44.130	21.680 / 143.447	0.020 / 66.787	0.876 / -22.008
600.0MHz	0.671 / -61.081	18.833 / 131.012	0.027 / 59.450	0.777 / -28.414
800.0MHz	0.580 / -75.399	16.329 / 120.409	0.032 / 54.083	0.697 / -33.155
1.000GHz	0.519 / -89.272	14.343 / 111.444	0.035 / 50.795	0.630 / -36.093
1.200GHz	0.477 / -98.767	12.690 / 105.102	0.039 / 48.253	0.572 / -37.202
1.400GHz	0.433 / -108.753	11.257 / 99.629	0.041 / 47.201	0.530 / -38.080
1.600GHz	0.401 / -118.061	10.171 / 93.876	0.044 / 46.174	0.496 / -39.429
1.800GHz	0.377 / -128.528	9.261 / 89.435	0.047 / 45.303	0.469 / -39.929
2.000GHz	0.360 / -136.535	8.481 / 84.373	0.050 / 44.259	0.446 / -41.699
2.200GHz	0.337 / -144.050	7.765 / 80.151	0.052 / 43.676	0.426 / -42.753
2.400GHz	0.329 / -155.326	7.224 / 76.067	0.055 / 42.747	0.410 / -43.976
2.600GHz	0.334 / -164.018	6.704 / 72.134	0.058 / 41.821	0.394 / -45.573
2.800GHz	0.335 / -170.211	6.292 / 68.234	0.061 / 40.479	0.381 / -47.395
3.000GHz	0.325 / -179.737	5.881 / 64.375	0.063 / 38.993	0.364 / -48.997

VCE = 2V, Icc = 13mA

freq	S(1,1)	S(2,1)	S(1,2)	S(2,2)
400.0MHz	0.718 / -50.867	24.068 / 139.016	0.019 / 64.279	0.839 / -23.938
600.0MHz	0.610 / -69.098	20.256 / 126.120	0.025 / 57.646	0.731 / -29.924
800.0MHz	0.521 / -84.187	17.146 / 115.571	0.029 / 53.197	0.647 / -33.849
1.000GHz	0.454 / -99.160	14.824 / 106.860	0.033 / 50.371	0.583 / -35.954
1.200GHz	0.426 / -108.492	12.951 / 100.848	0.036 / 49.347	0.531 / -36.230
1.400GHz	0.390 / -118.749	11.385 / 95.770	0.039 / 48.654	0.495 / -36.555
1.600GHz	0.363 / -128.397	10.220 / 90.287	0.041 / 47.871	0.465 / -37.478
1.800GHz	0.348 / -139.221	9.262 / 86.164	0.044 / 47.693	0.442 / -37.675
2.000GHz	0.332 / -146.480	8.452 / 81.355	0.047 / 46.852	0.423 / -39.241
2.200GHz	0.324 / -154.155	7.708 / 77.327	0.050 / 46.349	0.406 / -40.193
2.400GHz	0.319 / -164.632	7.157 / 73.433	0.053 / 45.392	0.393 / -41.366
2.600GHz	0.321 / -171.723	6.633 / 69.614	0.056 / 44.566	0.379 / -42.967
2.800GHz	0.324 / -179.233	6.207 / 65.973	0.059 / 43.419	0.367 / -44.771
3.000GHz	0.325 / 172.222	5.802 / 62.232	0.062 / 41.950	0.353 / -46.322

VCE = 2V, Icc = 15mA

freq	S(1,1)	S(2,1)	S(1,2)	S(2,2)
400.0MHz	0.670 / -55.053	25.128 / 136.242	0.019 / 63.325	0.815 / -24.962
600.0MHz	0.570 / -74.062	20.741 / 123.144	0.024 / 56.416	0.702 / -30.487
800.0MHz	0.483 / -90.487	17.318 / 112.738	0.028 / 52.647	0.620 / -33.800
1.000GHz	0.425 / -105.257	14.838 / 104.259	0.031 / 50.851	0.559 / -35.357
1.200GHz	0.401 / -115.859	12.881 / 98.478	0.034 / 50.240	0.511 / -35.176
1.400GHz	0.368 / -126.032	11.278 / 93.602	0.037 / 49.579	0.478 / -35.285
1.600GHz	0.348 / -135.529	10.089 / 88.283	0.040 / 48.909	0.451 / -36.011
1.800GHz	0.337 / -144.736	9.122 / 84.286	0.043 / 48.986	0.431 / -36.118
2.000GHz	0.319 / -152.536	8.311 / 79.612	0.046 / 48.285	0.414 / -37.621
2.200GHz	0.316 / -160.143	7.563 / 75.762	0.049 / 47.780	0.399 / -38.534
2.400GHz	0.316 / -169.952	7.018 / 71.973	0.052 / 47.039	0.387 / -39.747
2.600GHz	0.322 / -177.631	6.499 / 68.403	0.055 / 46.257	0.374 / -41.396
2.800GHz	0.327 / 176.598	6.079 / 64.583	0.058 / 44.841	0.364 / -43.138
3.000GHz	0.326 / 167.356	5.679 / 60.953	0.061 / 43.612	0.350 / -44.799

VCE = 3V, Icc = 2mA

freq	S(1,1)	S(2,1)	S(1,2)	S(2,2)
400.0MHz	0.939 / -19.616	6.803 / 161.993	0.022 / 76.402	0.982 / -10.826
600.0MHz	0.907 / -28.717	6.589 / 154.736	0.032 / 71.442	0.949 / -15.085
800.0MHz	0.877 / -37.112	6.375 / 147.270	0.041 / 65.614	0.923 / -19.740
1.000GHz	0.855 / -45.844	6.176 / 139.884	0.049 / 60.230	0.893 / -23.776
1.200GHz	0.817 / -53.640	5.961 / 133.694	0.056 / 55.620	0.859 / -27.086
1.400GHz	0.781 / -60.632	5.706 / 128.080	0.063 / 51.440	0.828 / -30.124
1.600GHz	0.750 / -68.703	5.492 / 121.626	0.068 / 47.389	0.795 / -33.567
1.800GHz	0.709 / -75.936	5.293 / 116.234	0.074 / 43.780	0.767 / -36.231
2.000GHz	0.675 / -82.618	5.070 / 110.188	0.078 / 39.930	0.738 / -39.838
2.200GHz	0.639 / -90.520	4.819 / 104.685	0.082 / 36.575	0.711 / -42.670
2.400GHz	0.607 / -98.557	4.663 / 99.190	0.085 / 33.207	0.686 / -45.427
2.600GHz	0.574 / -106.770	4.458 / 93.890	0.088 / 30.173	0.660 / -48.280
2.800GHz	0.547 / -114.282	4.278 / 89.065	0.091 / 27.003	0.639 / -51.193
3.000GHz	0.515 / -122.049	4.109 / 83.500	0.093 / 23.793	0.612 / -53.754

VCE = 3V, Icc = 3mA

freq	S(1,1)	S(2,1)	S(1,2)	S(2,2)
400.0MHz	0.926 / -23.029	9.682 / 158.957	0.022 / 75.260	0.971 / -12.789
600.0MHz	0.871 / -34.097	9.256 / 150.525	0.031 / 68.998	0.929 / -17.794
800.0MHz	0.830 / -43.746	8.802 / 142.003	0.039 / 62.687	0.891 / -22.936
1.000GHz	0.789 / -53.742	8.390 / 133.841	0.046 / 57.424	0.849 / -27.235
1.200GHz	0.753 / -62.788	7.949 / 127.232	0.052 / 52.902	0.805 / -30.571
1.400GHz	0.704 / -70.457	7.468 / 121.308	0.058 / 48.927	0.765 / -33.523
1.600GHz	0.667 / -78.707	7.075 / 114.658	0.062 / 45.254	0.727 / -36.790
1.800GHz	0.620 / -86.616	6.711 / 109.263	0.066 / 42.053	0.694 / -39.174
2.000GHz	0.591 / -94.150	6.340 / 103.220	0.069 / 38.713	0.661 / -42.458
2.200GHz	0.553 / -101.796	5.958 / 97.876	0.072 / 36.106	0.632 / -44.945
2.400GHz	0.519 / -110.889	5.685 / 92.685	0.075 / 33.285	0.606 / -47.326
2.600GHz	0.490 / -119.371	5.373 / 87.703	0.077 / 30.898	0.580 / -49.841
2.800GHz	0.478 / -127.383	5.114 / 83.011	0.080 / 28.349	0.559 / -52.396
3.000GHz	0.447 / -137.006	4.856 / 78.067	0.081 / 26.049	0.533 / -54.696

VCE = 3V, Icc = 4mA

freq	S(1,1)	S(2,1)	S(1,2)	S(2,2)
400.0MHz	0.895 / -26.695	12.166 / 156.246	0.021 / 73.764	0.960 / -14.496
600.0MHz	0.845 / -38.721	11.473 / 146.883	0.030 / 67.060	0.907 / -20.031
800.0MHz	0.785 / -49.322	10.747 / 137.691	0.038 / 60.756	0.860 / -25.438
1.000GHz	0.734 / -60.586	10.081 / 129.088	0.044 / 55.359	0.809 / -29.782
1.200GHz	0.694 / -69.719	9.404 / 122.226	0.049 / 50.835	0.758 / -32.950
1.400GHz	0.645 / -77.901	8.725 / 116.222	0.054 / 47.710	0.714 / -35.666
1.600GHz	0.597 / -86.687	8.157 / 109.633	0.057 / 44.284	0.672 / -38.670
1.800GHz	0.555 / -95.293	7.648 / 104.329	0.061 / 41.710	0.637 / -40.674
2.000GHz	0.526 / -102.285	7.165 / 98.446	0.063 / 38.928	0.605 / -43.642
2.200GHz	0.491 / -110.458	6.670 / 93.340	0.066 / 36.794	0.576 / -45.767
2.400GHz	0.460 / -119.912	6.316 / 88.354	0.068 / 34.564	0.551 / -47.853
2.600GHz	0.438 / -128.320	5.932 / 83.591	0.071 / 32.674	0.527 / -50.047
2.800GHz	0.425 / -135.914	5.620 / 79.125	0.073 / 30.597	0.507 / -52.398
3.000GHz	0.400 / -145.337	5.317 / 74.352	0.075 / 28.501	0.483 / -54.449

VCE = 3V, Icc = 5mA

freq	S(1,1)	S(2,1)	S(1,2)	S(2,2)
400.0MHz	0.872 / -30.603	14.395 / 153.788	0.021 / 73.135	0.948 / -16.031
600.0MHz	0.814 / -42.928	13.384 / 143.656	0.029 / 65.343	0.886 / -21.936
800.0MHz	0.742 / -54.604	12.334 / 133.986	0.036 / 59.209	0.830 / -27.461
1.000GHz	0.688 / -66.319	11.406 / 125.075	0.042 / 54.217	0.773 / -31.714
1.200GHz	0.647 / -75.138	10.512 / 118.186	0.046 / 50.023	0.717 / -34.619
1.400GHz	0.595 / -84.137	9.640 / 112.218	0.050 / 46.952	0.670 / -36.995
1.600GHz	0.549 / -93.290	8.925 / 105.729	0.053 / 44.292	0.629 / -39.671
1.800GHz	0.508 / -101.813	8.302 / 100.598	0.056 / 42.070	0.594 / -41.352
2.000GHz	0.477 / -109.919	7.727 / 94.881	0.059 / 39.693	0.563 / -44.034
2.200GHz	0.449 / -117.746	7.154 / 89.988	0.062 / 38.045	0.535 / -45.854
2.400GHz	0.415 / -127.430	6.742 / 85.201	0.064 / 36.298	0.511 / -47.715
2.600GHz	0.406 / -135.521	6.306 / 80.606	0.066 / 34.566	0.489 / -49.726
2.800GHz	0.389 / -143.979	5.961 / 76.321	0.069 / 32.830	0.470 / -51.871
3.000GHz	0.365 / -153.953	5.616 / 71.890	0.071 / 31.018	0.448 / -53.783

VCE = 3V, Icc = 7mA

freq	S(1,1)	S(2,1)	S(1,2)	S(2,2)
400.0MHz	0.833 / -34.556	17.850 / 149.861	0.020 / 69.504	0.925 / -18.409
600.0MHz	0.758 / -49.917	16.181 / 138.645	0.028 / 62.962	0.848 / -24.736
800.0MHz	0.674 / -62.168	14.560 / 128.370	0.034 / 56.963	0.779 / -30.183
1.000GHz	0.616 / -73.841	13.192 / 119.296	0.039 / 52.728	0.715 / -34.086
1.200GHz	0.572 / -84.205	11.931 / 112.538	0.042 / 49.012	0.656 / -36.317
1.400GHz	0.518 / -93.367	10.757 / 106.744	0.046 / 46.871	0.609 / -38.169
1.600GHz	0.475 / -102.107	9.854 / 100.495	0.049 / 44.727	0.569 / -40.255
1.800GHz	0.441 / -111.809	9.071 / 95.684	0.051 / 43.480	0.536 / -41.432
2.000GHz	0.411 / -120.226	8.369 / 90.247	0.054 / 41.697	0.507 / -43.662
2.200GHz	0.388 / -127.327	7.710 / 85.663	0.057 / 40.648	0.483 / -45.106
2.400GHz	0.371 / -137.871	7.219 / 81.187	0.059 / 39.202	0.462 / -46.637
2.600GHz	0.355 / -146.529	6.729 / 76.946	0.062 / 38.114	0.442 / -48.393
2.800GHz	0.350 / -155.017	6.335 / 72.870	0.064 / 36.513	0.426 / -50.341
3.000GHz	0.338 / -164.383	5.941 / 68.645	0.066 / 34.938	0.406 / -52.086

VCE = 3V, Icc = 10mA

freq	S(1,1)	S(2,1)	S(1,2)	S(2,2)
400.0MHz	0.779 / -42.217	21.921 / 144.591	0.019 / 67.144	0.888 / -21.277
600.0MHz	0.683 / -57.762	19.192 / 132.413	0.026 / 60.572	0.793 / -27.696
800.0MHz	0.597 / -72.020	16.732 / 121.856	0.031 / 55.329	0.714 / -32.603
1.000GHz	0.529 / -85.587	14.782 / 112.822	0.035 / 51.626	0.647 / -35.723
1.200GHz	0.483 / -95.293	13.111 / 106.407	0.038 / 49.373	0.589 / -37.002
1.400GHz	0.439 / -104.956	11.665 / 100.972	0.041 / 48.189	0.546 / -38.061
1.600GHz	0.403 / -113.665	10.557 / 95.143	0.044 / 46.775	0.510 / -39.467
1.800GHz	0.373 / -123.201	9.635 / 90.677	0.047 / 46.075	0.482 / -40.075
2.000GHz	0.357 / -131.575	8.828 / 85.591	0.049 / 44.832	0.457 / -41.858
2.200GHz	0.338 / -139.831	8.081 / 81.395	0.052 / 44.081	0.437 / -42.960
2.400GHz	0.330 / -149.640	7.529 / 77.185	0.055 / 43.241	0.420 / -44.243
2.600GHz	0.325 / -159.554	6.995 / 73.252	0.058 / 42.338	0.403 / -45.813
2.800GHz	0.321 / -166.494	6.563 / 69.429	0.060 / 40.899	0.389 / -47.634
3.000GHz	0.316 / -175.773	6.141 / 65.487	0.063 / 39.407	0.372 / -49.254

VCE = 3V, Icc = 13mA

freq	S(1,1)	S(2,1)	S(1,2)	S(2,2)
400.0MHz	0.723 / -47.001	24.407 / 140.763	0.019 / 65.889	0.857 / -23.089
600.0MHz	0.621 / -65.150	20.796 / 128.031	0.025 / 59.384	0.752 / -29.253
800.0MHz	0.531 / -79.592	17.759 / 117.477	0.029 / 54.478	0.669 / -33.489
1.000GHz	0.478 / -93.458	15.444 / 108.691	0.032 / 51.895	0.603 / -35.852
1.200GHz	0.435 / -103.411	13.538 / 102.559	0.035 / 50.440	0.549 / -36.447
1.400GHz	0.394 / -113.317	11.946 / 97.416	0.039 / 49.706	0.510 / -36.958
1.600GHz	0.367 / -122.420	10.744 / 91.836	0.041 / 48.540	0.479 / -37.974
1.800GHz	0.340 / -132.635	9.760 / 87.680	0.044 / 48.362	0.454 / -38.264
2.000GHz	0.325 / -140.767	8.916 / 82.815	0.047 / 47.371	0.433 / -39.862
2.200GHz	0.314 / -148.686	8.134 / 78.811	0.050 / 46.605	0.416 / -40.835
2.400GHz	0.307 / -158.882	7.562 / 74.851	0.053 / 45.790	0.401 / -42.016
2.600GHz	0.308 / -166.837	7.012 / 71.028	0.056 / 44.908	0.386 / -43.545
2.800GHz	0.311 / -173.853	6.575 / 67.296	0.059 / 43.600	0.374 / -45.301
3.000GHz	0.309 / 177.094	6.147 / 63.577	0.061 / 42.363	0.358 / -46.960

VCE = 3V, Icc = 15mA

freq	S(1,1)	S(2,1)	S(1,2)	S(2,2)
400.0MHz	0.692 / -51.030	25.578 / 138.478	0.019 / 63.822	0.837 / -24.027
600.0MHz	0.584 / -69.581	21.446 / 125.582	0.024 / 58.455	0.728 / -29.857
800.0MHz	0.500 / -84.204	18.088 / 115.121	0.028 / 54.096	0.645 / -33.616
1.000GHz	0.439 / -98.397	15.607 / 106.476	0.031 / 52.051	0.581 / -35.563
1.200GHz	0.406 / -108.099	13.624 / 100.575	0.034 / 50.727	0.530 / -35.748
1.400GHz	0.375 / -118.379	11.967 / 95.563	0.037 / 50.582	0.494 / -36.000
1.600GHz	0.351 / -128.177	10.730 / 90.146	0.040 / 49.751	0.465 / -36.840
1.800GHz	0.329 / -138.070	9.725 / 86.107	0.043 / 49.424	0.443 / -37.008
2.000GHz	0.315 / -146.009	8.868 / 81.400	0.046 / 48.624	0.424 / -38.547
2.200GHz	0.304 / -153.239	8.084 / 77.443	0.049 / 48.031	0.408 / -39.457
2.400GHz	0.303 / -163.638	7.509 / 73.618	0.052 / 47.168	0.394 / -40.665
2.600GHz	0.309 / -171.755	6.953 / 69.863	0.055 / 46.336	0.381 / -42.168
2.800GHz	0.308 / -179.109	6.515 / 66.245	0.058 / 44.992	0.370 / -43.995
3.000GHz	0.312 / 173.252	6.083 / 62.509	0.061 / 43.586	0.355 / -45.593