

# DATA SHEET

**BFS540**

**NPN 9 GHz wideband transistor**

Product specification  
File under Discrete Semiconductors, SC14

November 1992

## NPN 9 GHz wideband transistor

## BFS540

## FEATURES

- High power gain
- Low noise figure
- High transition frequency
- Gold metallization ensures excellent reliability
- SOT323 envelope.

## PINNING

PIN	DESCRIPTION
Code: N4	
1	base
2	emitter
3	collector

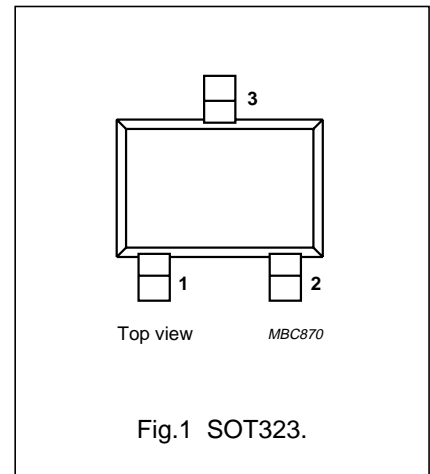

## DESCRIPTION

NPN transistor in a plastic SOT323 envelope.

It is intended for RF wideband amplifier applications such as satellite TV systems and RF portable communication equipment with signal frequencies up to 2 GHz.

## QUICK REFERENCE DATA

SYMBOL	PARAMETER	CONDITIONS	MIN.	TYP.	MAX.	UNIT
$V_{CBO}$	collector-base voltage	open emitter	–	–	20	V
$V_{CEO}$	collector-emitter voltage	open base	–	–	15	V
$I_C$	DC collector current		–	–	120	mA
$P_{tot}$	total power dissipation	up to $T_s = 80\text{ °C}$ ; note 1	–	–	500	mW
$h_{FE}$	DC current gain	$I_C = 40\text{ mA}$ ; $V_{CE} = 8\text{ V}$ ; $T_j = 25\text{ °C}$	60	120	250	
$f_T$	transition frequency	$I_C = 40\text{ mA}$ ; $V_{CE} = 8\text{ V}$ ; $f = 1\text{ GHz}$ ; $T_{amb} = 25\text{ °C}$	–	9	–	GHz
$G_{UM}$	maximum unilateral power gain	$I_C = 40\text{ mA}$ ; $V_{CE} = 8\text{ V}$ ; $f = 900\text{ MHz}$ ; $T_{amb} = 25\text{ °C}$	–	14	–	dB
F	noise figure	$I_C = 10\text{ mA}$ ; $V_{CE} = 8\text{ V}$ ; $f = 900\text{ MHz}$ ; $T_{amb} = 25\text{ °C}$	–	1.3	1.7	dB

## LIMITING VALUES

In accordance with the Absolute Maximum System (IEC 134).

SYMBOL	PARAMETER	CONDITIONS	MIN.	MAX.	UNIT
$V_{CBO}$	collector-base voltage	open emitter	–	20	V
$V_{CES}$	collector-emitter voltage	$R_{BE} = 0$	–	15	V
$V_{EBO}$	emitter-base voltage	open collector	–	2.5	V
$I_C$	DC collector current		–	120	mA
$P_{tot}$	total power dissipation	up to $T_s = 80\text{ °C}$ ; note 1	–	500	mW
$T_{stg}$	storage temperature		–65	150	°C
$T_j$	junction temperature		–	175	°C

## Note

1.  $T_s$  is the temperature at the soldering point of the collector tab.

## NPN 9 GHz wideband transistor

BFS540

## THERMAL RESISTANCE

SYMBOL	PARAMETER	CONDITIONS	THERMAL RESISTANCE
$R_{th\ j-s}$	thermal resistance from junction to soldering point	up to $T_s = 80\text{ °C}$ ; note 1	190 K/W

## Note

- $T_s$  is the temperature at the soldering point of the collector tab.

## CHARACTERISTICS

$T_j = 25\text{ °C}$ , unless otherwise specified.

SYMBOL	PARAMETER	CONDITIONS	MIN.	TYP.	MAX.	UNIT
$I_{CBO}$	collector cut-off current	$I_E = 0$ ; $V_{CE} = 8\text{ V}$	–	–	50	nA
$h_{FE}$	DC current gain	$I_C = 40\text{ mA}$ ; $V_{CE} = 8\text{ V}$	60	120	250	
$C_e$	emitter capacitance	$I_C = i_c = 0$ ; $V_{EB} = 0.5\text{ V}$ ; $f = 1\text{ MHz}$	–	2	–	pF
$C_c$	collector capacitance	$I_E = i_e = 0$ ; $V_{CB} = 8\text{ V}$ ; $f = 1\text{ MHz}$	–	0.9	–	pF
$C_{re}$	feedback capacitance	$I_C = 0$ ; $V_{CB} = 8\text{ V}$ ; $f = 1\text{ MHz}$	–	0.6	–	pF
$f_T$	transition frequency	$I_C = 40\text{ mA}$ ; $V_{CE} = 8\text{ V}$ ; $f = 1\text{ GHz}$ ; $T_{amb} = 25\text{ °C}$	–	9	–	GHz
$G_{UM}$	maximum unilateral power gain (note 1)	$I_C = 40\text{ mA}$ ; $V_{CE} = 8\text{ V}$ ; $f = 900\text{ MHz}$ ; $T_{amb} = 25\text{ °C}$	–	14	–	dB
		$I_C = 40\text{ mA}$ ; $V_{CE} = 8\text{ V}$ ; $f = 2\text{ GHz}$ ; $T_{amb} = 25\text{ °C}$	–	8	–	dB
$ S_{21} ^2$	insertion power gain	$I_C = 40\text{ mA}$ ; $V_{CE} = 8\text{ V}$ ; $f = 900\text{ MHz}$ ; $T_{amb} = 25\text{ °C}$	12	13	–	dB
F	noise figure	$\Gamma_s = \Gamma_{opt}$ ; $I_C = 10\text{ mA}$ ; $V_{CE} = 8\text{ V}$ ; $f = 900\text{ MHz}$ ; $T_{amb} = 25\text{ °C}$	–	1.3	1.8	dB
		$\Gamma_s = \Gamma_{opt}$ ; $I_C = 40\text{ mA}$ ; $V_{CE} = 8\text{ V}$ ; $f = 900\text{ MHz}$ ; $T_{amb} = 25\text{ °C}$	–	1.9	2.4	dB
		$\Gamma_s = \Gamma_{opt}$ ; $I_C = 10\text{ mA}$ ; $V_{CE} = 8\text{ V}$ ; $f = 2\text{ GHz}$ ; $T_{amb} = 25\text{ °C}$	–	2.1	–	dB
$P_{L1}$	output power at 1 dB gain compression	$I_C = 40\text{ mA}$ ; $V_{CE} = 8\text{ V}$ ; $R_L = 50\text{ }\Omega$ ; $f = 900\text{ MHz}$ ; $T_{amb} = 25\text{ °C}$	–	21	–	dBm
ITO	third order intercept point	note 2	–	34	–	dBm

## Notes

- $G_{UM}$  is the maximum unilateral power gain, assuming  $S_{12}$  is zero and

$$G_{UM} = 10 \log \left( \frac{|S_{21}|^2}{(1 - |S_{11}|^2)(1 - |S_{22}|^2)} \right) \text{ dB.}$$

- $I_C = 40\text{ mA}$ ;  $V_{CE} = 8\text{ V}$ ;  $R_L = 50\text{ }\Omega$ ;  $f = 900\text{ MHz}$ ;  $T_{amb} = 25\text{ °C}$ ;  
 $f_p = 900\text{ MHz}$ ;  $f_q = 902\text{ MHz}$ ; measured at  $f_{(2p-q)} = 898\text{ MHz}$  and at  $f_{(2q-p)} = 904\text{ MHz}$ .

NPN 9 GHz wideband transistor

BFS540

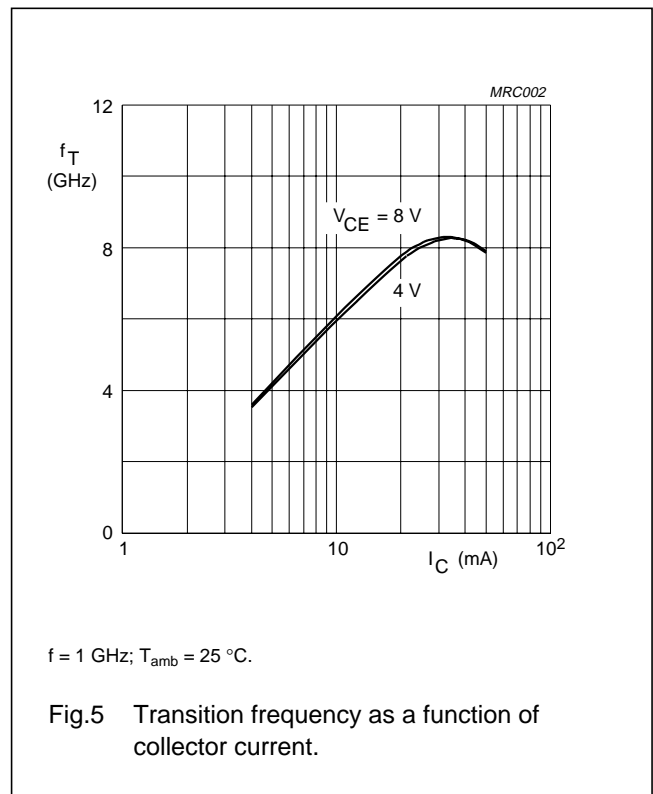
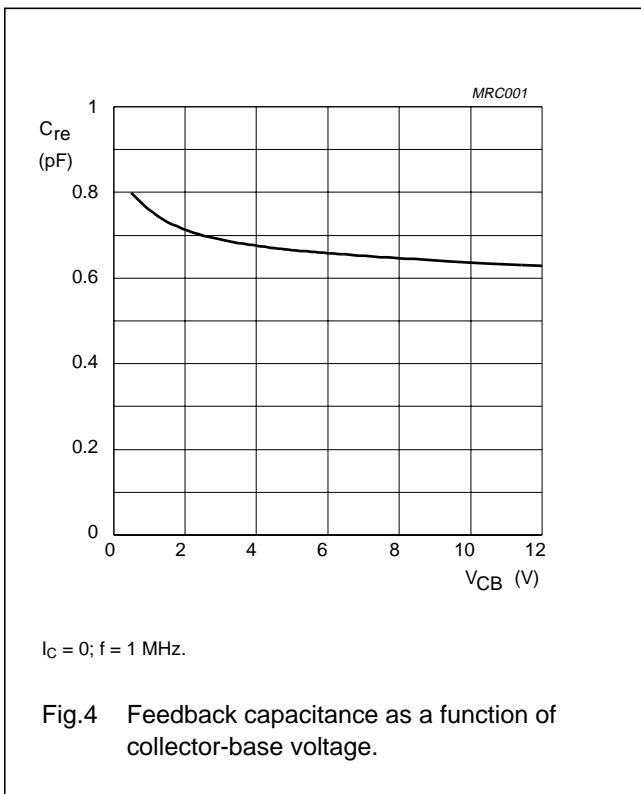
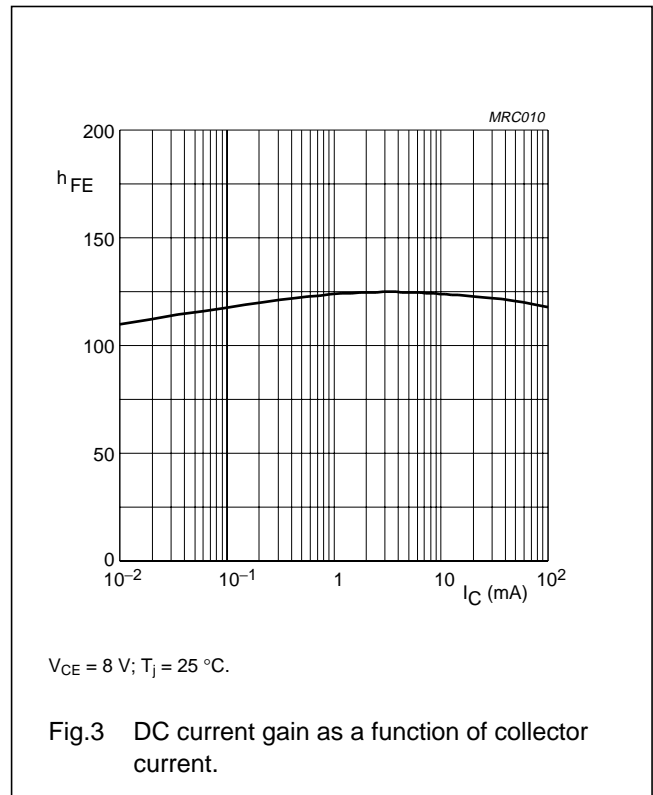
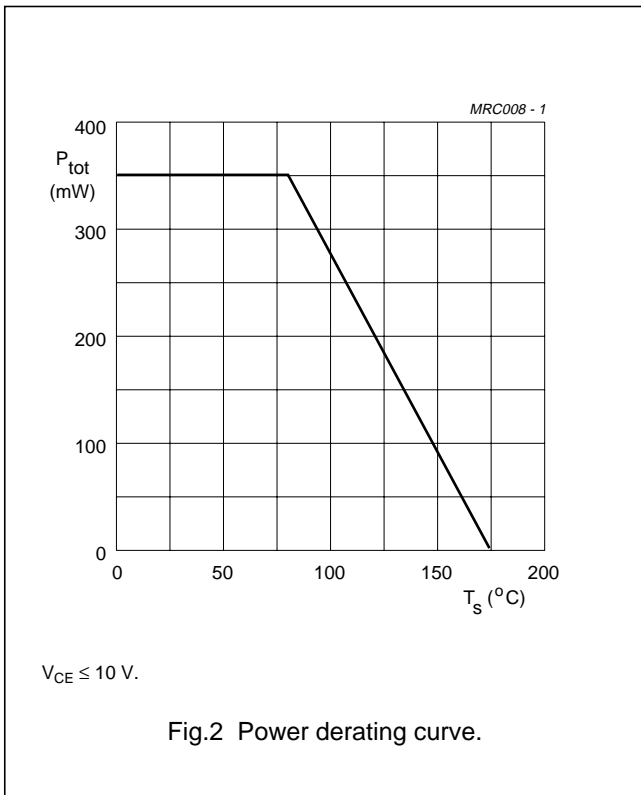

NPN 9 GHz wideband transistor

BFS540

In Figs 6 to 9,  $G_{UM}$  = maximum unilateral power gain;  $MSG$  = maximum stable gain;  $G_{max}$  = maximum available gain.

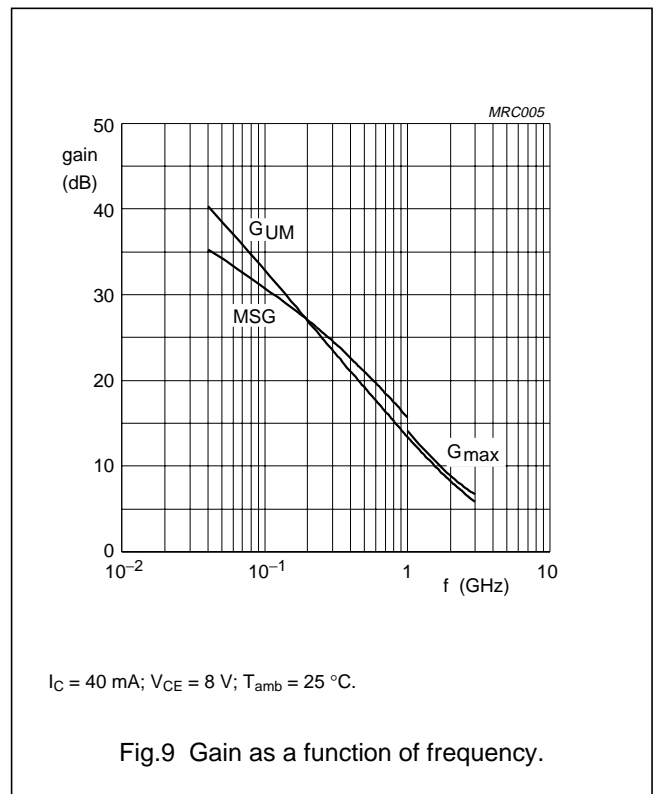
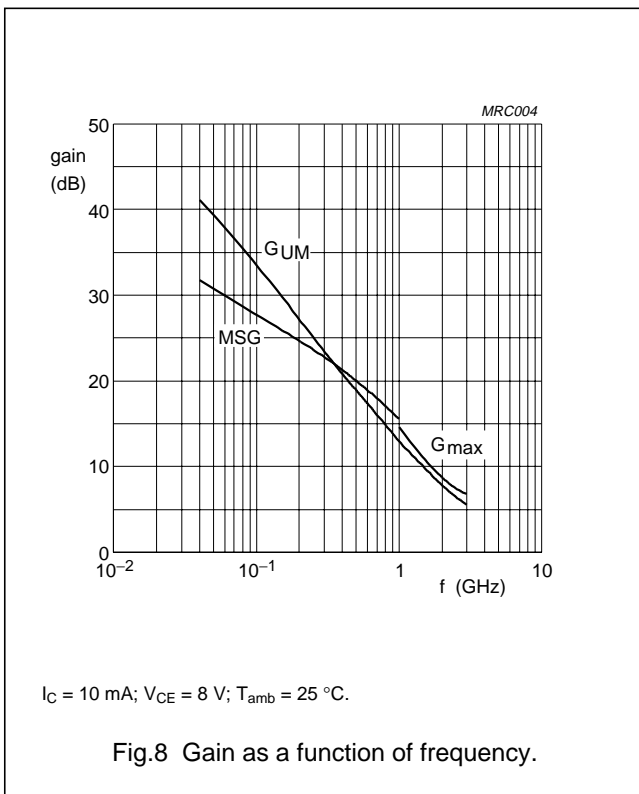
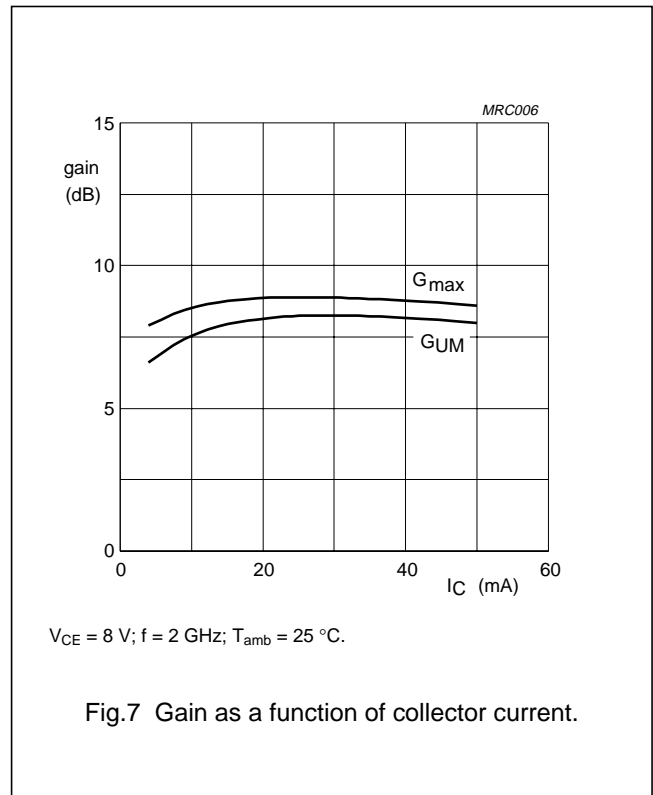
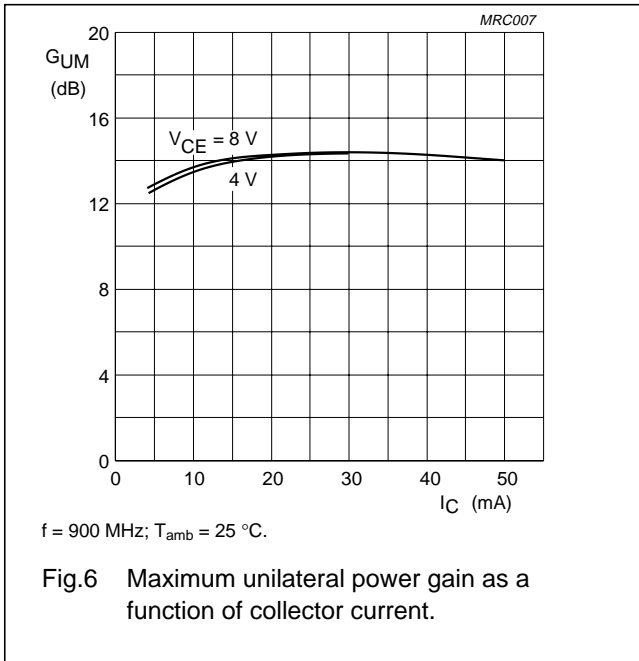

NPN 9 GHz wideband transistor

BFS540

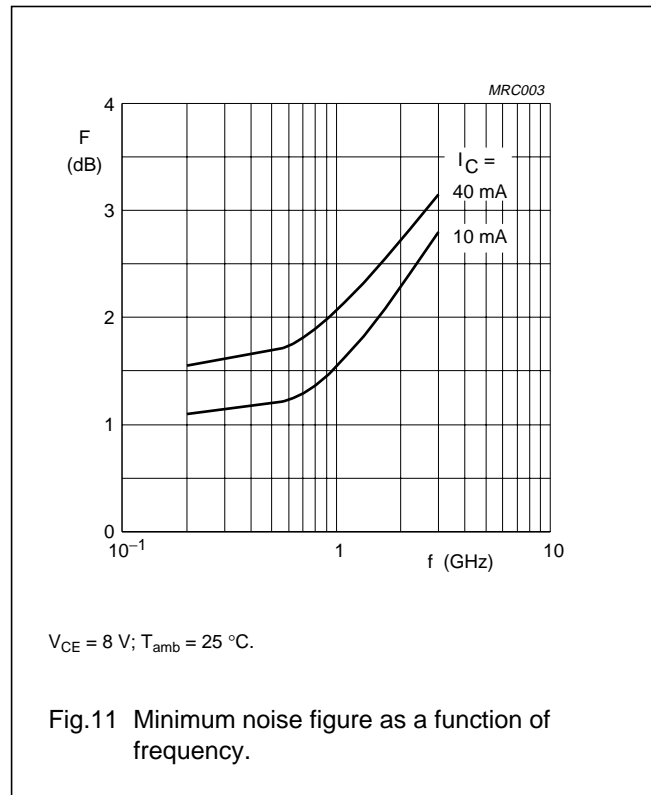
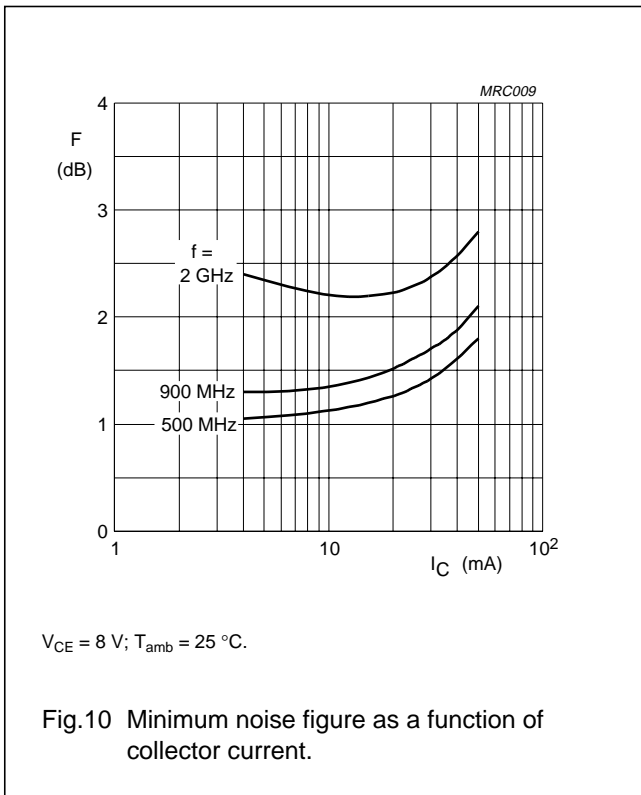

NPN 9 GHz wideband transistor

BFS540

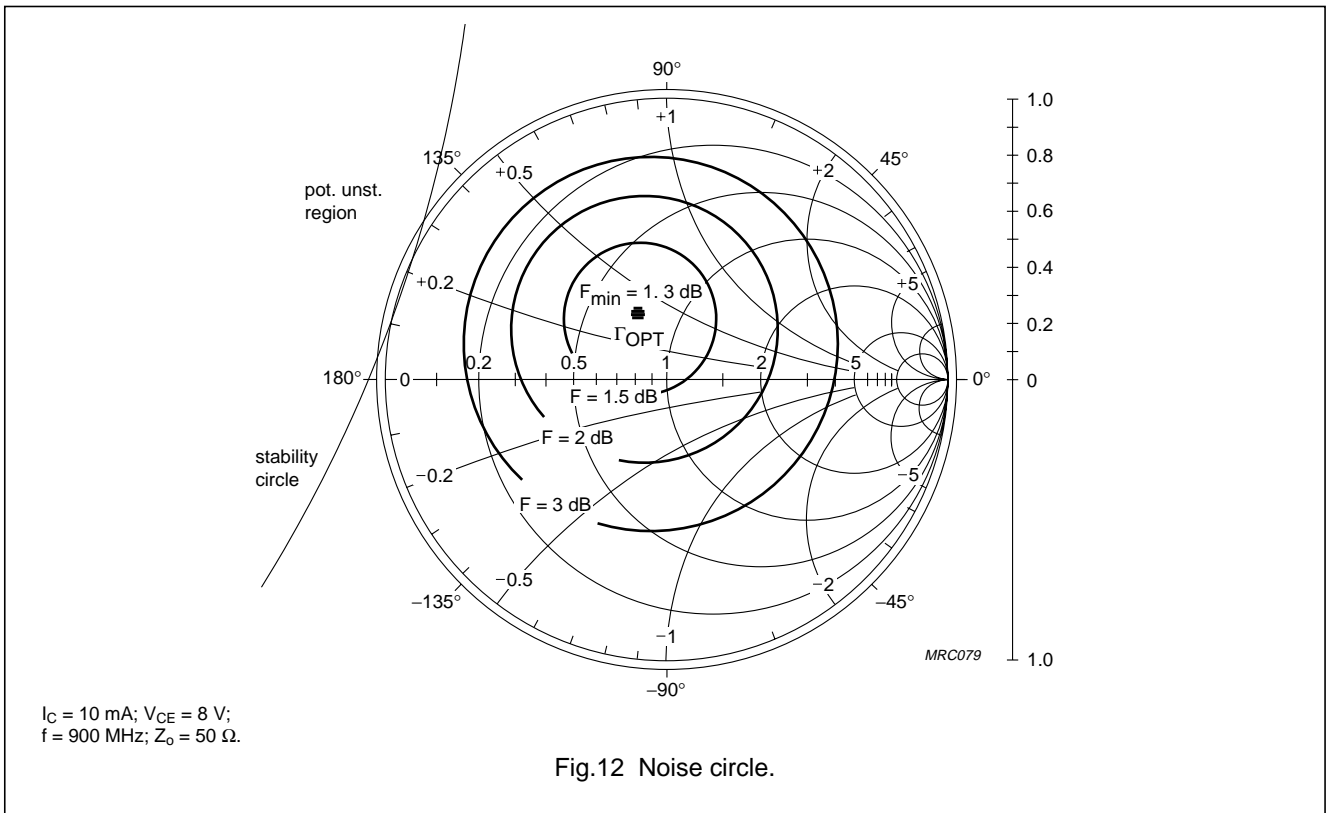

Fig.12 Noise circle.

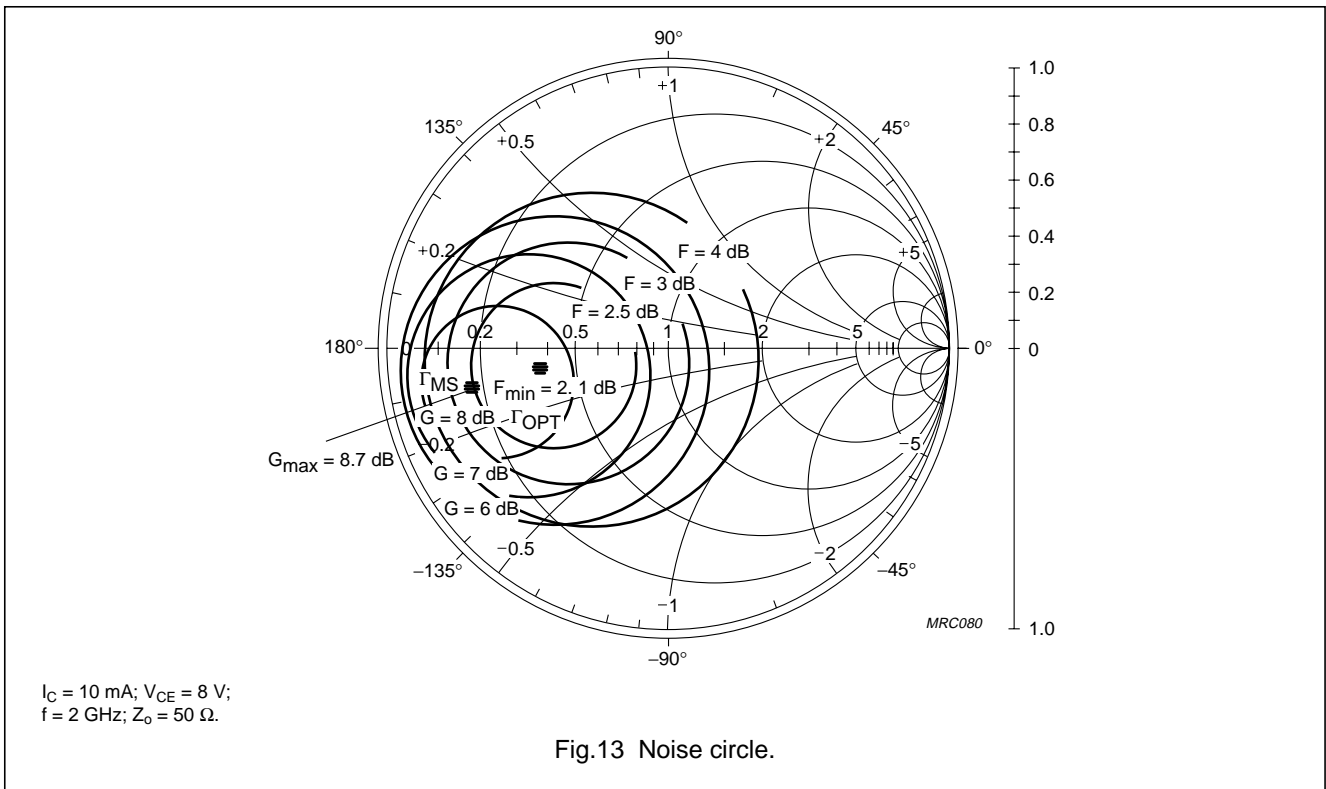
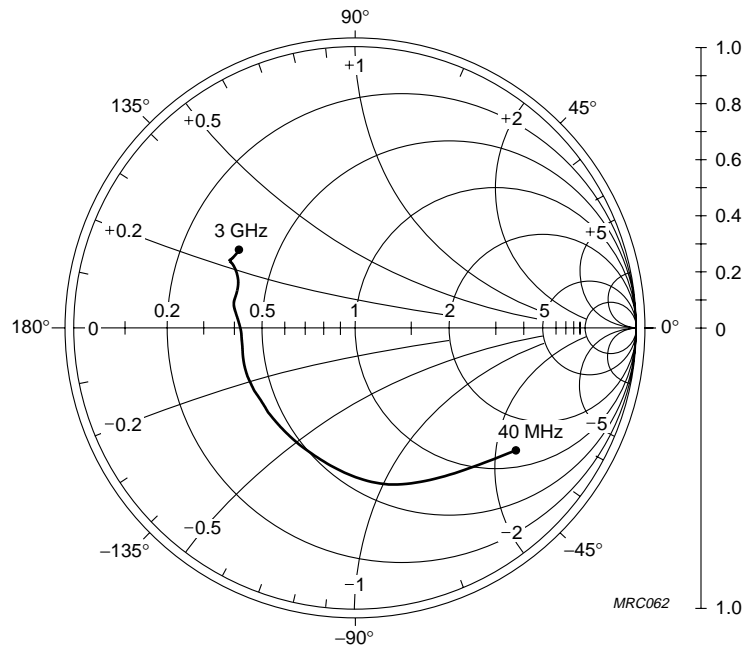

Fig.13 Noise circle.

NPN 9 GHz wideband transistor

BFS540



$I_C = 40 \text{ mA}$ ;  $V_{CE} = 8 \text{ V}$ ;  
 $Z_0 = 50 \Omega$ .

Fig.14 Common emitter input reflection coefficient ( $S_{11}$ ).

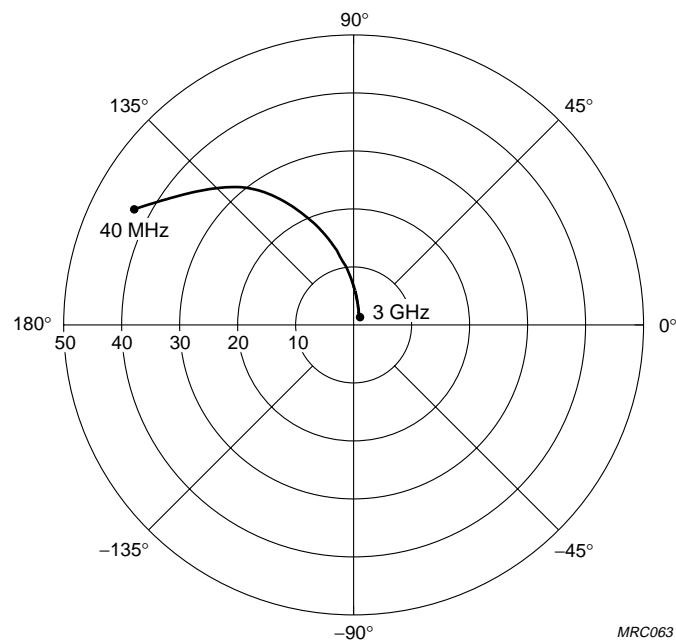

$I_C = 40 \text{ mA}$ ;  $V_{CE} = 8 \text{ V}$ .

Fig.15 Common emitter forward transmission coefficient ( $S_{21}$ ).



NPN 9 GHz wideband transistor

BFS540

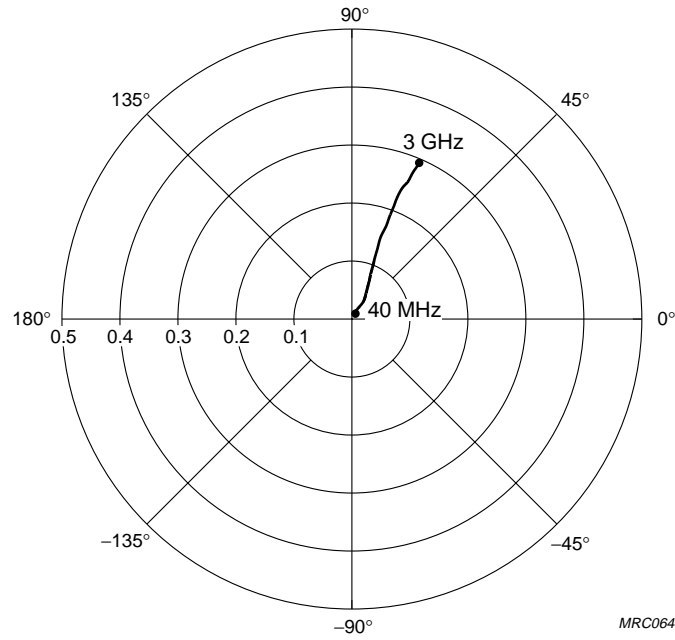

$I_C = 40 \text{ mA}; V_{CE} = 8 \text{ V}.$

Fig.16 Common emitter reverse transmission coefficient ( $S_{12}$ ).

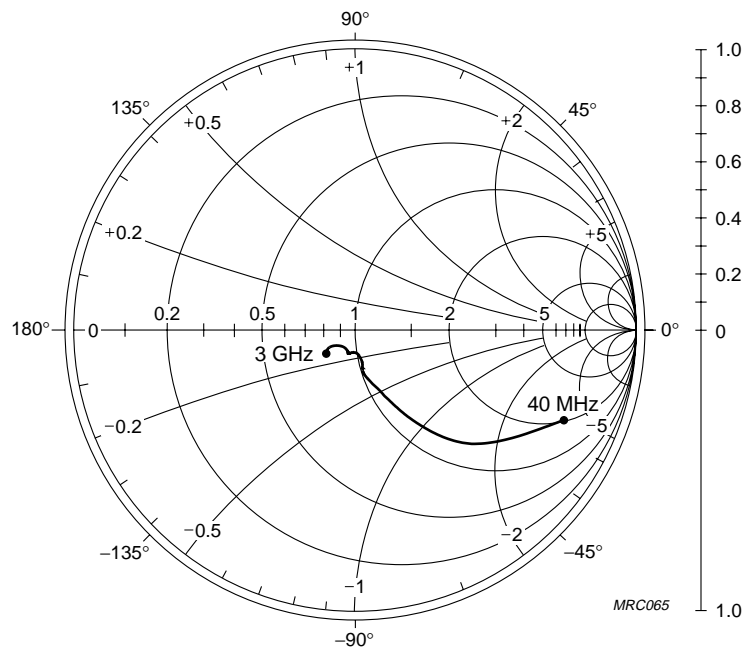

$I_C = 40 \text{ mA}; V_{CE} = 8 \text{ V};$   
 $Z_o = 50 \Omega.$

Fig.17 Common emitter output reflection coefficient ( $S_{22}$ ).

NPN 9 GHz wideband transistor

BFS540

PACKAGE OUTLINE

Plastic surface mounted package; 3 leads

SOT323

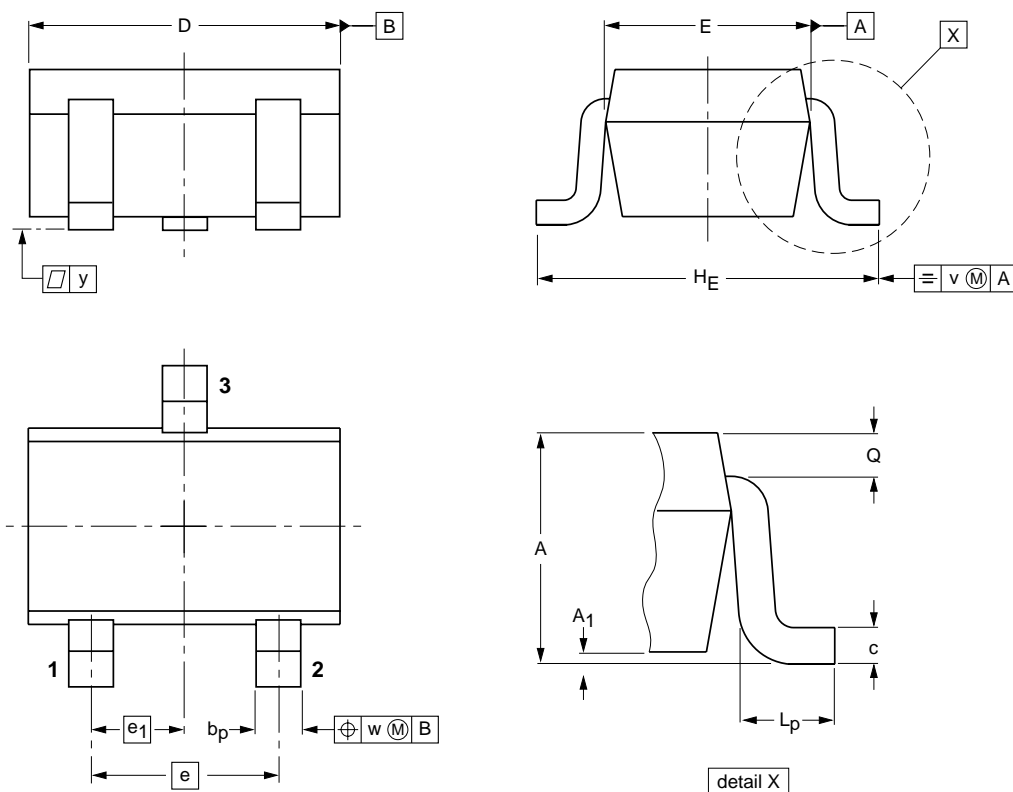

DIMENSIONS (mm are the original dimensions)

UNIT	A	A <sub>1</sub> max	b <sub>p</sub>	c	D	E	e	e <sub>1</sub>	H <sub>E</sub>	L <sub>p</sub>	Q	v	w
mm	1.1 0.8	0.1	0.4 0.3	0.25 0.10	2.2 1.8	1.35 1.15	1.3	0.65	2.2 2.0	0.45 0.15	0.23 0.13	0.2	0.2

OUTLINE VERSION	REFERENCES				EUROPEAN PROJECTION	ISSUE DATE
	IEC	JEDEC	EIAJ			
SOT323			SC-70			97-02-28

## NPN 9 GHz wideband transistor

BFS540

**DEFINITIONS**

<b>Data Sheet Status</b>	
Objective specification	This data sheet contains target or goal specifications for product development.
Preliminary specification	This data sheet contains preliminary data; supplementary data may be published later.
Product specification	This data sheet contains final product specifications.
<b>Limiting values</b>	
Limiting values given are in accordance with the Absolute Maximum Rating System (IEC 134). Stress above one or more of the limiting values may cause permanent damage to the device. These are stress ratings only and operation of the device at these or at any other conditions above those given in the Characteristics sections of the specification is not implied. Exposure to limiting values for extended periods may affect device reliability.	
<b>Application information</b>	
Where application information is given, it is advisory and does not form part of the specification.	

**LIFE SUPPORT APPLICATIONS**

These products are not designed for use in life support appliances, devices, or systems where malfunction of these products can reasonably be expected to result in personal injury. Philips customers using or selling these products for use in such applications do so at their own risk and agree to fully indemnify Philips for any damages resulting from such improper use or sale.