

# ILC7062

## SOT-23 CMOS LDO

### Features

- Low Power Consumption: typ 2.0 $\mu$ A at  $V_{OUT} = 5V$
- All-CMOS design in SOT-23 and SOT-89 packages gives optimal size and power performances.
- Highly accurate output  $\pm 2\%$  ( $\pm 1\%$ )
- Maximum output current: 250mA (Limited to 150mW power dissipation SOT-23, 500mW SOT-89)
- Output Voltage Range: 2.0V to 6.0V

### Applications

- Battery-powered Equipment
- Reference voltage sources
- Palmtops
- Portable cameras and video recorders

### Description

250mA CMOS LDO in a SOT-23 package, featuring 120mV of dropout voltage at 100mA and 380mV at 200mA current levels.

The part offers  $\pm 2\%$  accuracy on outputs, yet draws only 2 $\mu$ A of current. Short-circuit protection is standard.

The part comes in both 3-lead SOT-23 (150mW) and 3-lead SOT-89 (500mW) to handle a variety of voltage and current levels.

Transient response to load variations have improved in comparison to the existing series.

Low Power consumption and high accuracy is achieved through CMOS and laser trimming technologies.

### Typical Applications

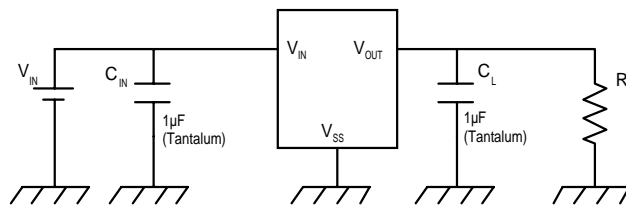

## Pin Assignments

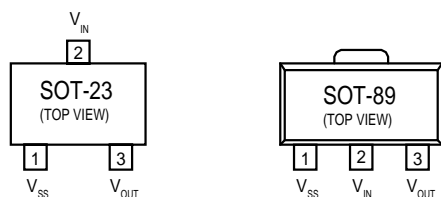

## Internal Block Diagram

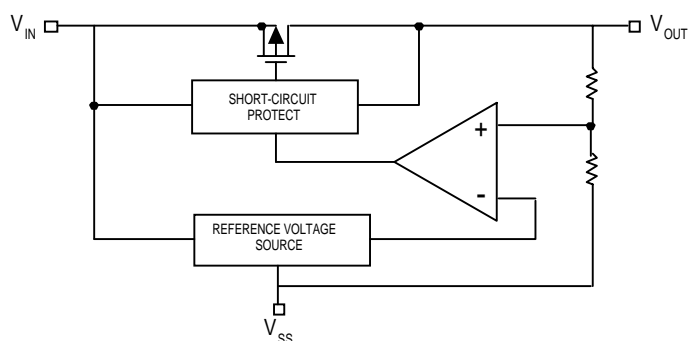

## Absolute Maximum Ratings

Parameter	Symbol	Ratings	Units	
Input Voltage	$V_{IN}$	12	V	
Output Current (Note 3)	$I_{OUTmax}$	500	mA	
Output Voltage (Note 1)	$V_{OUT}$	$V_{SS}-0.3 \sim V_{IN}+0.3$	V	
Continuous Total Power Dissipation	SOT-23	$P_D$	150	mW
	SOT-89		500	
Operating Ambient Temperature	$T_{opr}$	-40~+85	°C	
Storage Temperature	$T_{stg}$	-40~+125	°C	

## Electrical Characteristics ILC7062CP-50

$T_A = 25^\circ\text{C}$

Parameter	Symbol	Conditions	Min.	Typ.	Max.	Units
Output Voltage	$V_{OUT}$	$I_{OUT} = 40\text{mA}$ , $V_{IN} = 6.0\text{V}$	4.90	5.0	5.10	V
Maximum Output Current	$I_{OUTmax}$	$V_{IN} = 6.0\text{V}$ , $V_{OUT} \geq 4.5\text{V}$	250			mA
Load Stability	$\Delta V_{OUT}$	Conditions		40	80	mV
Input/Output Voltage Differential (Note 2)	$V_{dif}$	$I_{OUT} = 100\text{mA}$ $I_{OUT} = 200\text{mA}$		120 380	300 600	mV
Supply Current	$I_{SS}$	$V_{IN} = 6.0\text{V}$		2	4.5	$\mu\text{A}$
Input Stability	$\frac{\Delta V_{OUT}}{\Delta V_{IN} \cdot V_{OUT}}$	$I_{OUT} = 40\text{mA}$ $6.0\text{V} \leq V_{IN} \leq 10.0\text{V}$		0.2	0.3	%/V
Input Voltage	$V_{IN}$				10.0	V
Output Voltage Temperature Characteristics	$\frac{\Delta V_{OUT}}{\Delta T_{opr} \cdot V_{OUT}}$	$I_{OUT} = 40\text{mA}$ $-40^\circ\text{C} \leq T_{opr} \leq 85^\circ\text{C}$		$\pm 100$		ppm/ $^\circ\text{C}$

### Notes:

- $V_{OUT}$  means the output voltage when " $V_{OUT} + 1.0\text{V}$ " is provided at the  $V_{IN}$  pin while maintaining a certain  $I_{OUT}$  value.
- $V_{dif}$  is defined as " $V_{IN} - V_{OUT}$ " where  $V_{OUT} = V_{SET} \times 0.98$ .
- $I_{OUTmax}$  = This is specified for SOT-89 package. For SOT-23, it is limited by continuous total power dissipation.

## Electrical Characteristics ILC7062CP-33

$T_A = ^\circ\text{C}$

Parameter	Symbol	Conditions	Min.	Typ.	Max.	Units
Output Voltage	$V_{OUT}$	$I_{OUT} = 40\text{mA}$ , $V_{IN} = 4.3\text{V}$	3.234	3.300	3.366	V
Maximum Output Current	$I_{OUTmax}$	$V_{IN} = 4.3\text{V}$ , $V_{OUT} \geq 2.97\text{V}$	50			mA
Load Stability	$\Delta V_{OUT}$	$V_{IN} = 4.3\text{V}$ , $1\text{mA} \leq I_{OUT} \leq 80\text{mA}$		45	90	mV
Input/Output Voltage Differential (Note 2)	$V_{dif}$	$I_{OUT} = 80\text{mA}$ $I_{OUT} = 160\text{mA}$		180 400	360 700	mV
Supply Current	$I_{SS}$	$V_{IN} = 4.0\text{V}$		2	4.5	$\mu\text{A}$
Input Stability	$\frac{\Delta V_{OUT}}{\Delta V_{IN} \cdot V_{OUT}}$	$I_{OUT} = 40\text{mA}$ $4.3\text{V} \leq V_{IN} \leq 10.0\text{V}$		0.2	0.3	%/V
Input Voltage	$V_{IN}$				10.0	V
Output Voltage Temperature Characteristics	$\frac{\Delta V_{OUT}}{\Delta T_{opr} \cdot V_{OUT}}$	$I_{OUT} = 40\text{mA}$ $-30^\circ\text{C} \leq T_{opr} \leq 80^\circ\text{C}$		$\pm 100$		ppm/ $^\circ\text{C}$

## Electrical Characteristics ILC7062CP-30

$T_A = 25^\circ\text{C}$

Parameter	Symbol	Conditions	Min.	Typ.	Max.	Units
Output Voltage	$V_{OUT}$	$I_{OUT} = 40\text{mA}$ , $V_{IN} = 4.0\text{V}$	2.94	3.0	3.06	V
Maximum Output Current	$I_{OUTmax}$	$V_{IN} = 4.0\text{V}$ , $V_{OUT} \geq 2.7\text{V}$	150			mA
Load Stability	$\Delta V_{OUT}$	$V_{IN} = 4.0\text{V}$ , $1\text{mA} \leq I_{OUT} \leq 80\text{mA}$		45	90	mV
Input/Output Voltage Differential (Note 2)	$V_{dif}$	$I_{OUT} = 80\text{mA}$ $I_{OUT} = 160\text{mA}$		180 400	360 700	mV
Supply Current	$I_{SS}$	$V_{IN} = 4.0\text{V}$		2	4.5	$\mu\text{A}$
Input Stability	$\frac{\Delta V_{OUT}}{\Delta V_{IN} \cdot \Delta V_{OUT}}$	$I_{OUT} = 40\text{mA}$ $4.0\text{V} \leq V_{IN} \leq 10.0\text{V}$		0.2	0.3	%/V
Input Voltage	$V_{IN}$				10.0	V
Output Voltage Temperature Characteristics	$\frac{\Delta V_{OUT}}{\Delta T_{opr} \cdot V_{OUT}}$	$I_{OUT} = 40\text{mA}$ $-30^\circ\text{C} \leq T_{opr} \leq 80^\circ\text{C}$		$\pm 100$		ppm/ $^\circ\text{C}$

### Notes:

- $V_{OUT}$  means the output voltage when “ $V_{OUT} + 1.0\text{V}$ ” is provided at the  $V_{IN}$  pin while maintaining a certain  $I_{OUT}$  value.
- $V_{dif}$  is defined as “ $V_{IN} - V_{OUT}$ ” where  $V_{OUT} = V_{SET} \times 0.98$ .
- $I_{OUTmax}$  = This is specified for SOT-89 package. For SOT-23, it is limited by continuous total power dissipation.

# Typical Performance Characteristics General conditions for all curves

**Output Voltage vs Output Current**

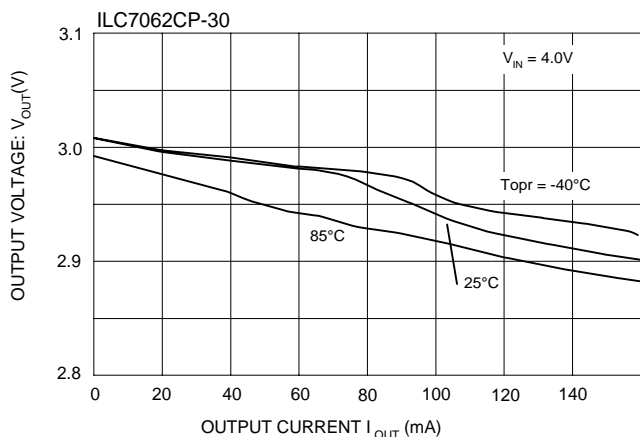

**V<sub>DO</sub> vs Output Current**

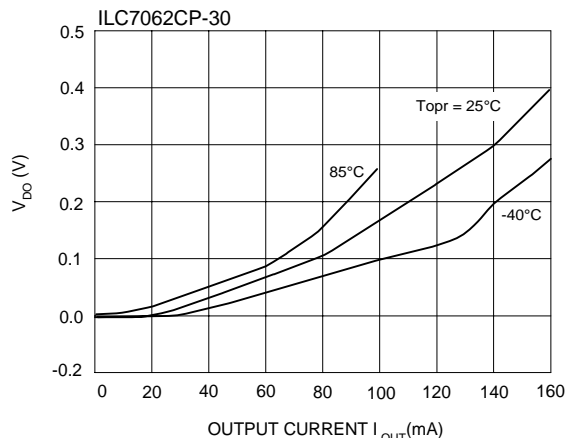

**Output Voltage vs Input Voltage**

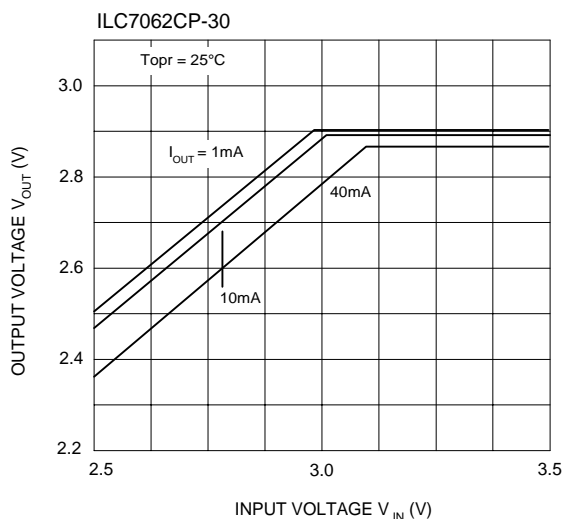

**Output Voltage vs Output Current**

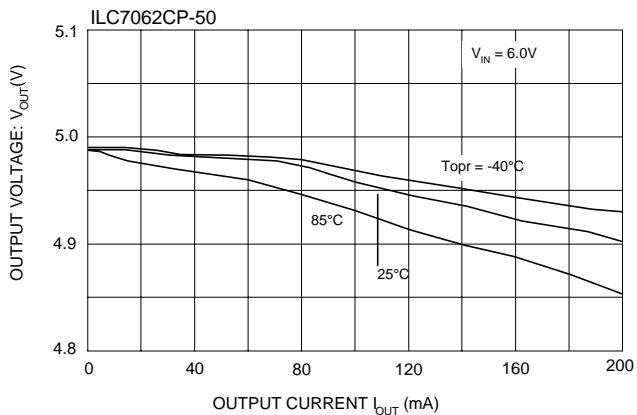

**Output Voltage vs Input Voltage**

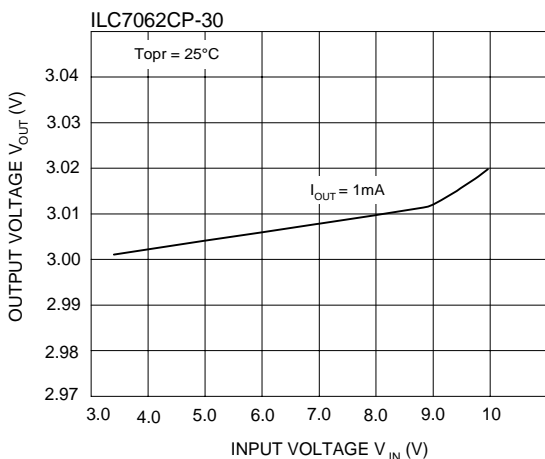

**Output Voltage vs Input Voltage**

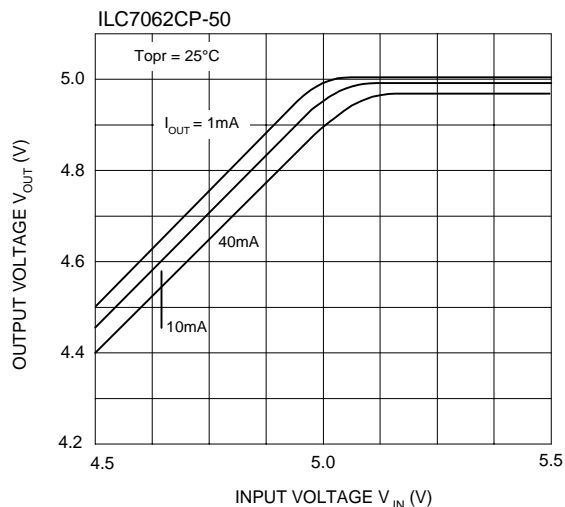

# Typical Performance Characteristics General conditions for all curves

**Output Voltage vs Input Voltage**

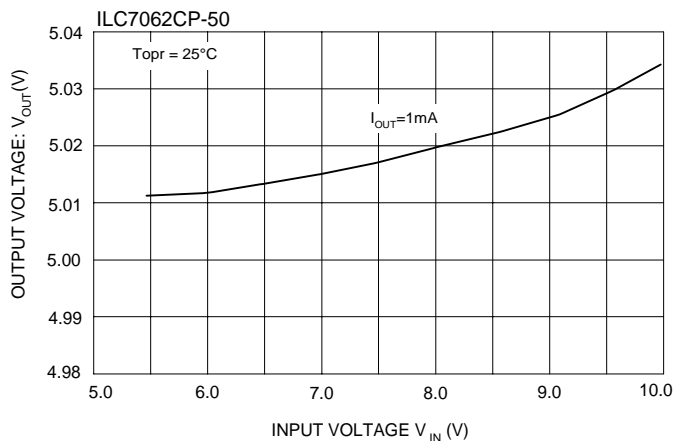

**I<sub>DD</sub> vs Input Voltage**

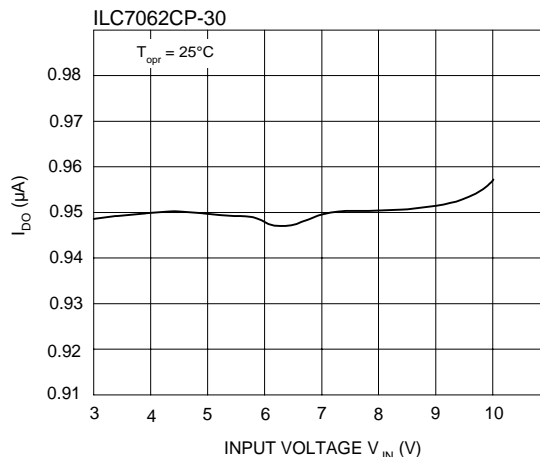

**V<sub>DD</sub> vs Output Current**

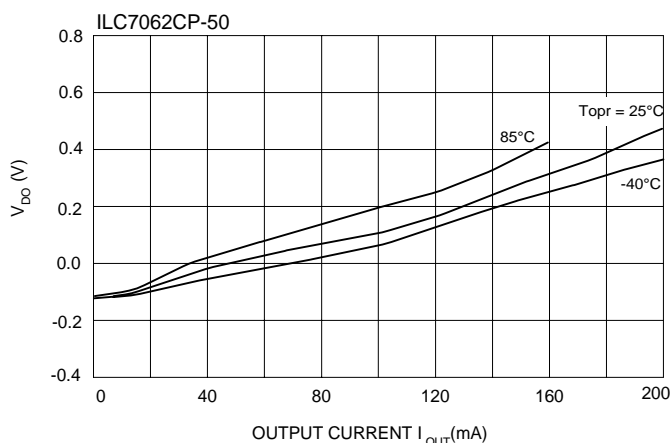

**I<sub>DD</sub> vs T<sub>opr</sub>**

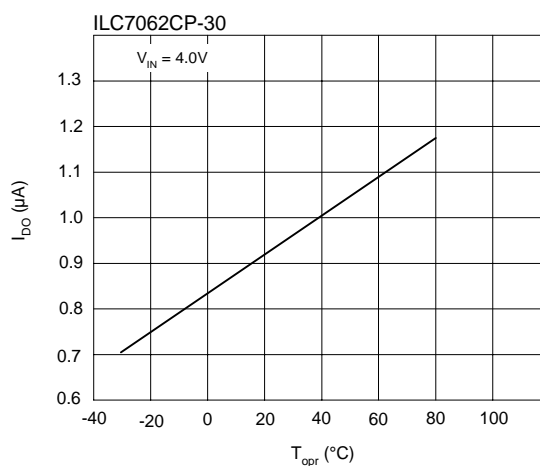

**Output Voltage vs Temperature**

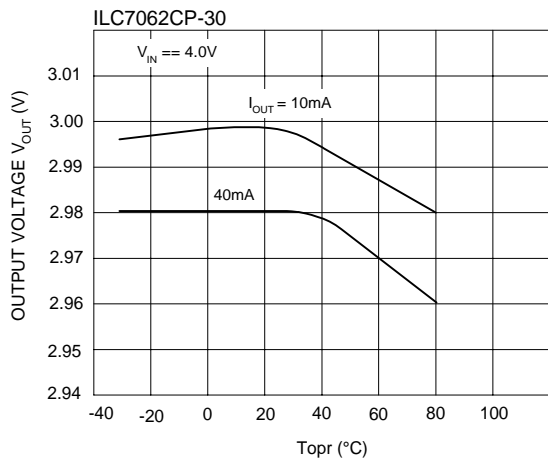

**Output Voltage vs Temperature**

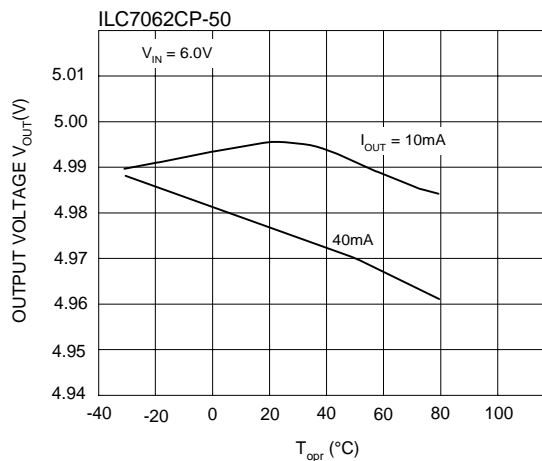

# Typical Performance Characteristics General conditions for all curves

**$I_{DD}$  vs Input Voltage**

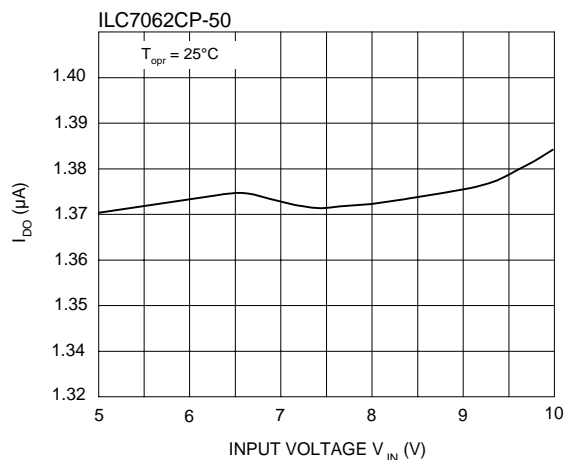

**$I_{DD}$  vs  $T_{opr}$**

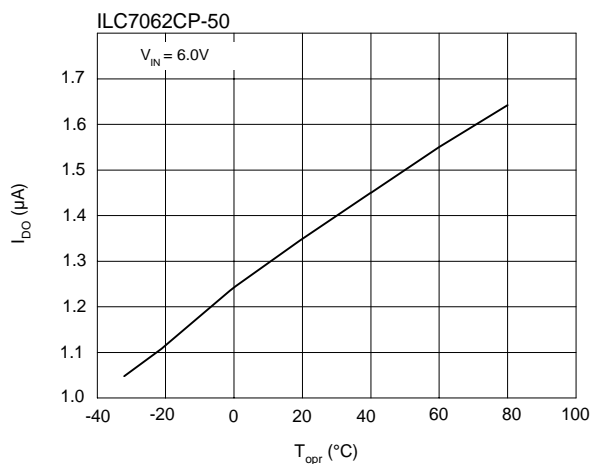

**Line Transient Response**

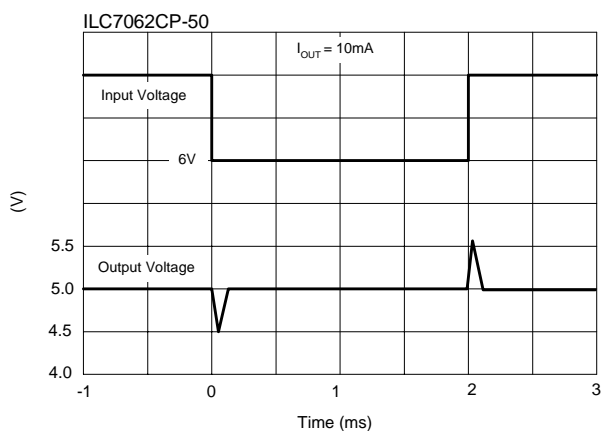

**Load Transient Response**

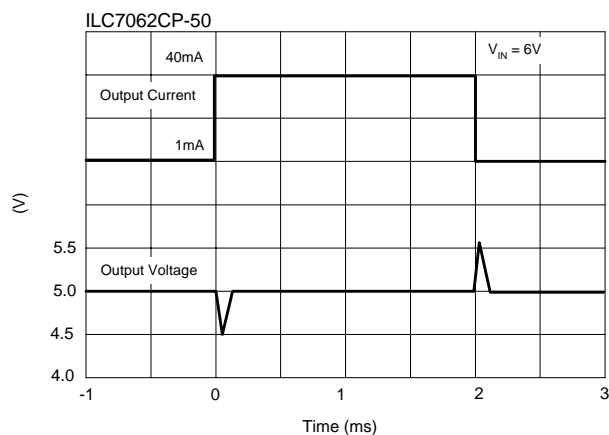

**Ripple Rejection Rate**

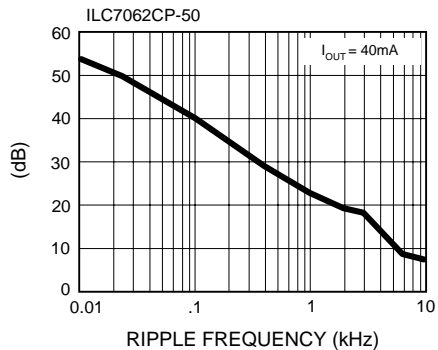

**Ripple Rejection Rate**

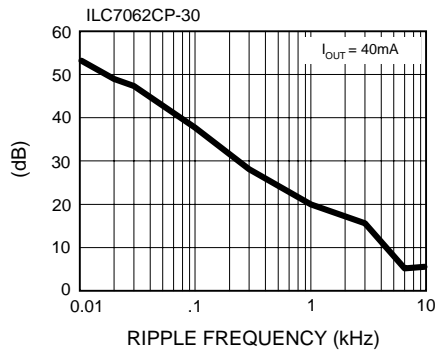

Ordering Information	
ILC7062CP-50	5.0V output, SOT-89*
ILC7062CM-50	5.0V output, SOT-23-3**
ILC7062CP-46	4.6V output, SOT-89*
ILC7062CP-33	3.3V output, SOT-89*
ILC7062CP-30	3.0V output, SOT-89*
ILC7062CP-25	2.5V output, SOT-89*
ILC7062CM-25	2.5V output, SOT-23-3**
	*Max power dissipation of 500mW **Max power dissipation of 150mW

\*Standard product offering comes in tape & reel, quantity 3000 per reel, orientation right for SOT-23, quantity 1000 per reel, orientation right for SOT-89

#### DISCLAIMER

FAIRCHILD SEMICONDUCTOR RESERVES THE RIGHT TO MAKE CHANGES WITHOUT FURTHER NOTICE TO ANY PRODUCTS HEREIN TO IMPROVE RELIABILITY, FUNCTION OR DESIGN. FAIRCHILD DOES NOT ASSUME ANY LIABILITY ARISING OUT OF THE APPLICATION OR USE OF ANY PRODUCT OR CIRCUIT DESCRIBED HEREIN; NEITHER DOES IT CONVEY ANY LICENSE UNDER ITS PATENT RIGHTS, NOR THE RIGHTS OF OTHERS.

#### LIFE SUPPORT POLICY

FAIRCHILD'S PRODUCTS ARE NOT AUTHORIZED FOR USE AS CRITICAL COMPONENTS IN LIFE SUPPORT DEVICES OR SYSTEMS WITHOUT THE EXPRESS WRITTEN APPROVAL OF THE PRESIDENT OF FAIRCHILD SEMICONDUCTOR CORPORATION. As used herein:

1. Life support devices or systems are devices or systems which, (a) are intended for surgical implant into the body, or (b) support or sustain life, and (c) whose failure to perform when properly used in accordance with instructions for use provided in the labeling, can be reasonably expected to result in a significant injury of the user.
2. A critical component in any component of a life support device or system whose failure to perform can be reasonably expected to cause the failure of the life support device or system, or to affect its safety or effectiveness.