

GTLP8T306 8-Bit LVTTTL/GTLP Bus Transceiver

General Description

The GTLP8T306 is an 8-bit bus transceiver that provides LVTTTL to GTLP signal level translation. The device provides a high speed interface between cards operating at LVTTTL logic levels and a backplane operating at GTLP logic levels. High speed backplane operation is a direct result of GTLP's reduced output swing (<1V), reduced input threshold levels and output edge rate control. The edge rate control minimizes bus settling time. GTLP is a Fairchild Semiconductor derivative of the Gunning Transceiver logic (GTL) JEDEC standard JESD8-3.

Fairchild's GTLP has internal output edge-rate control and is process, voltage, and temperature (PVT) compensated. Its function is similar to BTL and GTL but with different output levels and receiver thresholds. The GTLP output LOW level is typically less than 0.5V, the output HIGH level is 1.5V and the receiver threshold is 1.0V.

Features

- Bidirectional interface between GTLP and LVTTTL logic levels
- Designed with edge rate control circuitry to reduce output noise on the GTLP port
- V_{REF} pin provides external supply reference voltage for receiver threshold adjustability
- Special PVT Compensation circuitry to provide consistent performance over variations of process, supply voltage and temperature
- TTL compatible driver and control inputs
- Designed using Fairchild advanced CMOS technology
- Bushold data inputs on A port to eliminate the need for external pull-up resistors for unused inputs
- Power up/down and power off high impedance for live insertion
- 5V over voltage tolerance on LVTTTL ports
- Open drain on GTLP to support wired-or connection
- Flow through pinout optimizes PCB layout
- A Port source/sink -24mA/+24mA
- B Port sink +50mA

Ordering Code:

Order Number	Package Number	Package Description
GTLP8T306MTC	MTC24	24-Lead Thin Shrink Small Outline Package (TSSOP), JEDEC MO-153, 4.4mm Wide

Devices also available in Tape and Reel. Specify by appending the suffix letter "X" to the ordering code.

Connection Diagram

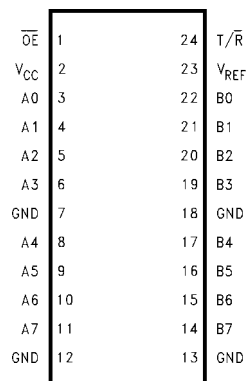

Pin Descriptions

Pin Names	Description
\overline{OE}	Output Enable (Active LOW)
T/\overline{R}	Transmit/Receive Input
A0–A7	Side A Inputs or 3-STATE Outputs
B0–B7	Side B Inputs or 3-STATE Outputs
V_{REF}	GTLP Reference Voltage

Truth Table

Inputs		Output
\overline{OE}	T/\overline{R}	
H	X	HIGH Z on Bus A and Bus B
L	L	Bus B Data to Bus A
L	H	Bus A Data to Bus B

Functional Description

The GTLP8T306 is an 8-bit transceiver providing the standard 245 functionality that supports both GTL and GTLP signal levels.

Data polarity is non-inverting and the data flow direction is controlled by the T/\overline{R} pin. The outputs are enabled to allow data through the device when \overline{OE} is LOW otherwise both the A and B ports are placed in a HIGH impedance state.

Logic Diagram

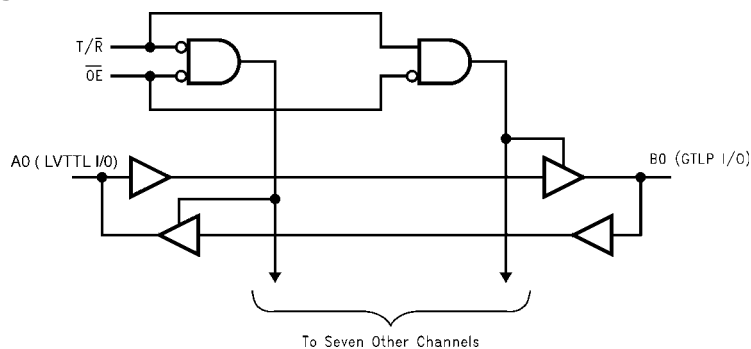

Absolute Maximum Ratings (Note 1)		Recommended Operating Conditions (Note 3)	
Supply Voltage (V_{CC})	-0.5V to 7.0V	Supply Voltage V_{CC}	3.15V to 3.45V
DC Input Voltage (V_I)	-0.5V to +7.0V	Bus Termination Voltage (V_{TT})	
DC Output Voltage (V_O)		GTL	1.35V to 1.65V
Outputs 3-STATE	-0.5V to +7.0V	GTL	1.14V to 1.26V
Outputs Active (Note 2)	-0.5V to 7.0V	Input Voltage (V_I) on A-Port and control pins	0V to 5.5V
DC Output Sink Current into A-Port, I_{OL}	48 mA	HIGH Level Output Current (I_{OH})	
DC Output Source Current from A Port I_{OH}	-48 mA	A Port	-24 mA
DC Output Sink Current into B-Port in the LOW State, I_{OL}	100 mA	LOW Level Output Current (I_{OL})	
DC Input Diode Current (I_{IK})		A Port	+24 mA
$V_I < 0V$	-50 mA	B Port	+50 mA
DC Output Diode Current (I_{OK})		Operating Temperature (T_A)	-40°C to +85°C
$V_O < 0V$	-50 mA		
$V_O > V_{CC}$	+50 mA		
ESD Rating	>2000V		
Storage Temperature (T_{STG})	-65°C to +150°C		

Note 1: The Absolute Maximum Ratings are those values beyond which the safety of the device cannot be guaranteed. The device should not be operated at these limits. The parametric values defined in the Electrical Characteristics tables are not guaranteed at the absolute maximum rating. The "Recommended Operating Conditions" table will define the conditions for actual device operation.

Note 2: I_O Absolute Maximum Rating must be observed.

Note 3: Unused inputs must be held HIGH or LOW.

DC Electrical Characteristics

Over Recommended Operating Free-Air Temperature Range, $V_{REF} = 1.0V$ (unless otherwise noted).

Symbol	Test Conditions	Min	Typ (Note 4)	Max	Units
V_{IH}	B Port	$V_{REF} + 0.05$		V_{TT}	V
	Others	2.0			V
V_{IL}	B Port	0.0		$V_{REF} - 0.05$	V
	Others			0.8	V
V_{REF}	GTL		1.0		V
	GTL		0.8		V
V_{IK}	$V_{CC} = 3.15V$	$I_I = -18 mA$		-1.2	V
V_{OH}	A Port	$V_{CC} = \text{Min to Max (Note 5)}$	$I_{OH} = -100 \mu A$	$V_{CC} - 0.2$	V
		$V_{CC} = 3.15V$	$I_{OH} = -12 mA$	2.4	
			$I_{OH} = -24 mA$	2.0	
V_{OL}	A Port	$V_{CC} = \text{Min to Max (Note 5)}$	$I_{OL} = 100 \mu A$		0.2
		$V_{CC} = 3.15V$	$I_{OL} = 24 mA$		0.5
	B Port	$V_{CC} = 3.15V$	$I_{OL} = 40 mA$		0.4
			$I_{OL} = 50 mA$		0.55
I_I	A Port	$V_{CC} = 3.45V$	$V_I = 5.5V$ $V_I = 0V$		20 -20
	Control Pins	$V_{CC} = 3.45V$	$V_I = 5.5V$ $V_I = 0V$		5 -5
	B Port	$V_{CC} = 3.45V$	$V_I = V_{TT}$ $V_I = 0$		5 -5
I_{OFF}	A Port	$V_{CC} = 0$	V_I or $V_O = 0$ to 4.5V		100
I_I (Hold)	A Port	$V_{CC} = 3.15V$	$V_I = 0.8V$	75	μA
			$V_I = 2.0V$	-20	
I_{OZH}	A Port	$V_{CC} = 3.45V$	$V_O = 3.45V$		20
	B Port		$V_O = 1.5V$		5
I_{OZL}	A Port	$V_{CC} = 3.45V$	$V_O = 0$		-20
	B Port	$V_{CC} = 3.45V$	$V_O = 0.55$		-5

DC Electrical Characteristics (Continued)

Symbol		Test Conditions		Min	Typ (Note 4)	Max	Units
I_{CC}	A or B Ports	$V_{CC} = 3.45V$ $I_O = 0$ $V_I = V_{CC}$ or GND	Outputs HIGH		7	18	mA
			Outputs LOW		8	20	
			Outputs Disabled		8	20	
I_{CC} (Note 6)	A Port and Control Pins	$V_{CC} = 3.45V$ A or Control Inputs at V_{CC} or GND	One Input at $V_{CC}-0.6V$		0	1	mA
C_{IN}	Control Pins		$V_I = V_{CC}$ or 0		5		pF
	A Port		$V_I = V_{CC}$ or 0		7		
	B Port		$V_I = V_{CC}$ or 0		9		

Note 4: All typical values are $V_{CC} = 3.3V$ and $T_A = 25^\circ C$.

Note 5: For conditions shown as Min, use the appropriate value specified under recommended operating conditions.

Note 6: This is the increase in supply current for each input that is at the specified LVTTTL voltage level rather than V_{CC} or GND.

AC Electrical Characteristics

Over recommended range of supply voltage and operating free air-temperature, $V_{REF} = 1.0V$ (unless otherwise noted).

$C_L = 30$ pF for B Port and $C_L = 50$ pF for A Port.

Symbol	From (Input)	To (Output)	Min	Typ (Note 7)	Max	Units
t_{PLH}	An	Bn	1.0	4.0	7.5	ns
t_{PHL}			1.0	5.1	7.5	
t_{PLH}	Bn	An	1.0	5.8	8.3	ns
t_{PHL}			1.0	4.9	8.3	
t_{RISE}	Transition Time, B Outputs (20% to 80%)			2.6		ns
t_{FALL}	Transition Time, B Outputs (20% to 80%)			2.6		ns
t_{RISE}	Transition Time, A Outputs (10% to 90%)			2.5		ns
t_{FALL}	Transition Time, A Outputs (10% to 90%)			2.5		ns
t_{PZH}, t_{PZL}	\overline{OE}	An	1.0	4.5	9.5	ns
t_{PHZ}, t_{PLZ}			1.0	4.9	9.5	
t_{PLH}	\overline{OE}	Bn	1.0	5.4	9.5	ns
t_{PHL}			1.0	6.0	9.5	

Note 7: All typical values are at $V_{CC} = 3.3V$ and $T_A = 25^\circ C$.

Test Circuit and Timing Waveforms

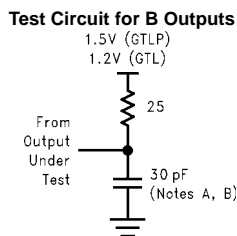
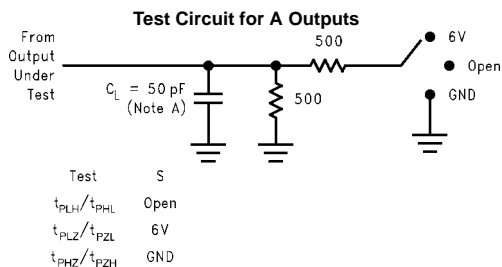

Voltage Waveforms Pulse Duration
($V_M = V_{CC}/2$ for A Port and 1.0 for B-Port)

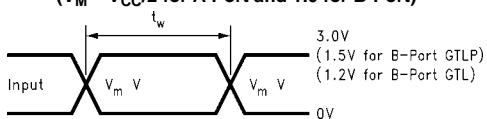

Voltage Waveforms Enable and Disable Times A Port

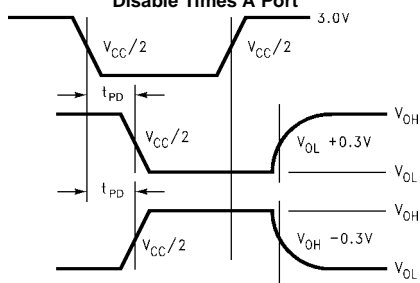

Voltage Waveforms Propagation Delay and Setup and Hold Times
($V_M = V_{CC}/2$ for A Port and 1.0 for B Port)

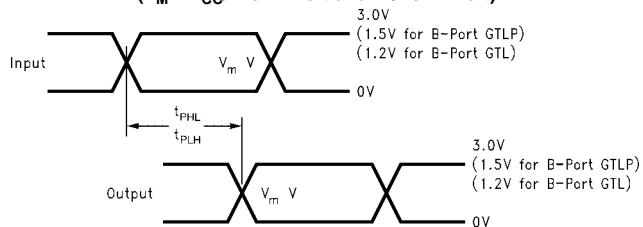

Note A: C_L includes probes and Jig capacitance.

Note B: For B Port, $C_L = 30 \text{ pF}$ is used for worst case.

Physical Dimensions inches (millimeters) unless otherwise noted

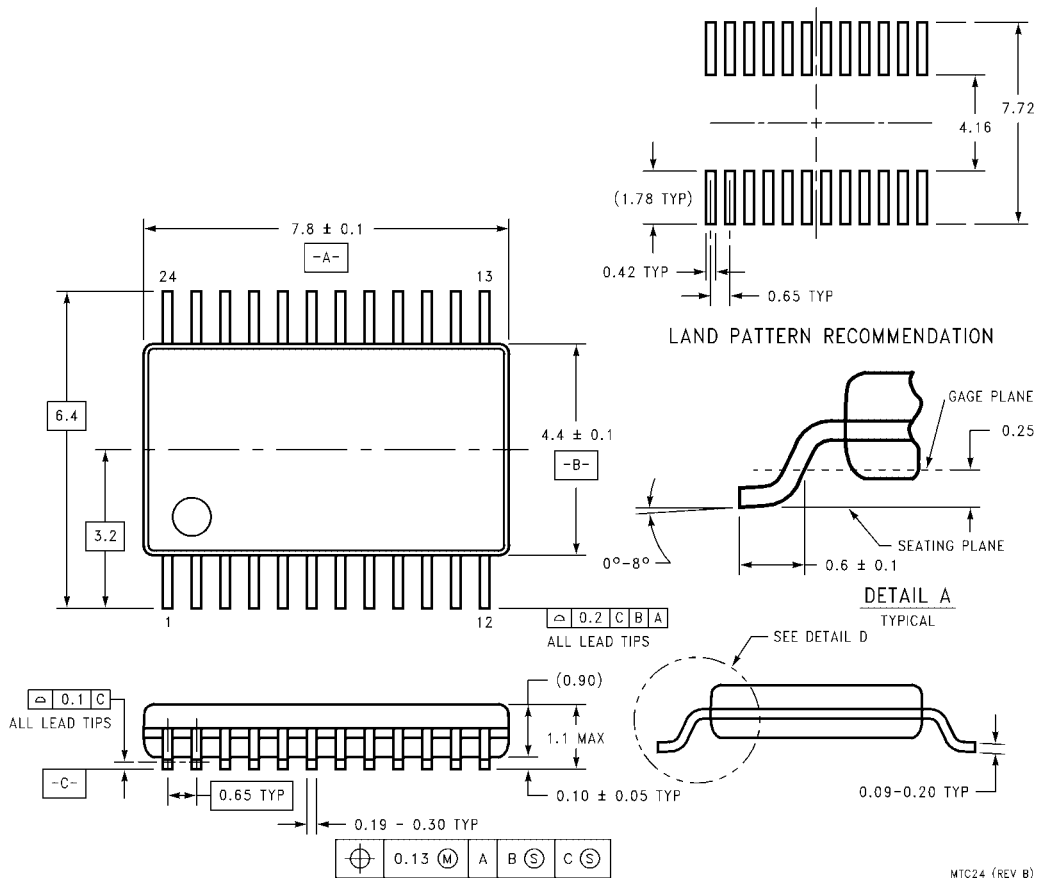

**24-Lead Thin Shrink Small Outline Package (TSSOP), JEDEC MO-153, 4.4mm Wide
Package Number MTC24**

MTC24 (REV B)

Fairchild does not assume any responsibility for use of any circuitry described, no circuit patent licenses are implied and Fairchild reserves the right at any time without notice to change said circuitry and specifications.

LIFE SUPPORT POLICY

FAIRCHILD'S PRODUCTS ARE NOT AUTHORIZED FOR USE AS CRITICAL COMPONENTS IN LIFE SUPPORT DEVICES OR SYSTEMS WITHOUT THE EXPRESS WRITTEN APPROVAL OF THE PRESIDENT OF FAIRCHILD SEMICONDUCTOR CORPORATION. As used herein:

1. Life support devices or systems are devices or systems which, (a) are intended for surgical implant into the body, or (b) support or sustain life, and (c) whose failure to perform when properly used in accordance with instructions for use provided in the labeling, can be reasonably expected to result in a significant injury to the user.
2. A critical component in any component of a life support device or system whose failure to perform can be reasonably expected to cause the failure of the life support device or system, or to affect its safety or effectiveness.

www.fairchildsemi.com