

GTLP6C816 GTLP/TTL 1:6 Clock Driver

General Description

The GTLP6C816 is a clock driver that provides TTL to GTLP signal level translation (and vice versa). The device provides a high speed interface between cards operating at TTL logic levels and a backplane operating at GTLP logic levels. High speed backplane operation is a direct result of GTLP's reduced output swing (<1V), reduced input threshold levels and output edge rate control. The edge rate control minimizes bus settling time. GTLP is a Fairchild Semiconductor derivative of the Gunning Transceiver logic (GTL) JEDEC standard JESD8-3.

Fairchild's GTLP has internal edge-rate control and is process, voltage, and temperature (PVT) compensated. Its function is similar to BTL and GTL but with different output levels and receiver threshold. GTLP output LOW level is typically less than 0.5V, the output level HIGH is 1.5V and the receiver threshold is 1.0V.

Features

- Interface between LVTTTL and GTLP logic levels
- Designed with edge rate control circuitry to reduce output noise on the GTLP port
- V_{REF} pin provides external supply reference voltage for receiver threshold adjustability
- Special PVT compensation circuitry to provide consistent performance over variations of process, supply voltage and temperature
- TTL compatible driver and control inputs
- Designed using Fairchild advanced CMOS technology
- Bushold data inputs on A port to eliminate the need for external pull-up resistors for unused inputs
- Power up/down and power off high impedance for live insertion
- 5V over voltage tolerance on LVTTTL ports
- Open drain on GTLP to support wired-or connection
- A Port source/sink $-24mA/+24mA$
- B Port sink $+50mA$
- 1:6 fanout clock driver for TTL port
- 1:2 fanout clock driver for GTLP port

Ordering Code:

Order Number	Package Number	Package Description
GTLP6C816MTC	MTC24	24-Lead Thin Shrink Small Outline Package (TSSOP), JEDEC MO-153, 4.4mm Wide

Device also available in Tape and Reel. Specify by appending the suffix letter "X" to the ordering code.

Pin Descriptions

Pin Names	Description
TTLIN, GTLPIN	Clock Inputs (TTL and GTLP respectively)
\overline{OEB}	Output Enable (Active LOW) GTLP Port (TTL Levels)
\overline{OEA}	Output Enable (Active LOW) TTL Port (TTL Levels)
V_{CCT} -GNDT	TTL Output Supplies (5V)
V_{CC}	Internal Circuitry V_{CC} (5V)
GNDG	OBn GTLP Output Grounds
V_{REF}	Voltage Reference Input
OA0-OA5	TTL Buffered Clock Outputs
OB0-OB1	GTLP Buffered Clock Outputs

Connection Diagram

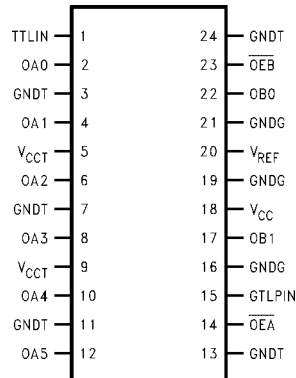

Functional Description

The GTLP6C816 is a clock driver providing TTL-to-GTLP clock translation, and GTLP-to-TTL clock translation in the same package. The TTL-to-GTLP direction is a 1:2 clock driver path with a single Enable pin (\overline{OEB}). For the GTLP-to-TTL direction the clock receiver path is a 1:6 buffer with a single Enable control (\overline{OEA}). Data polarity is inverting for both directions.

Truth Tables

Inputs		Outputs
TTLIN	\overline{OEB}	O _{Bn}
H	L	L
L	L	H
X	H	High Z

Inputs		Outputs
GTLPIN	\overline{OEA}	O _{An}
H	L	L
L	L	H
X	H	High Z

Logic Diagram

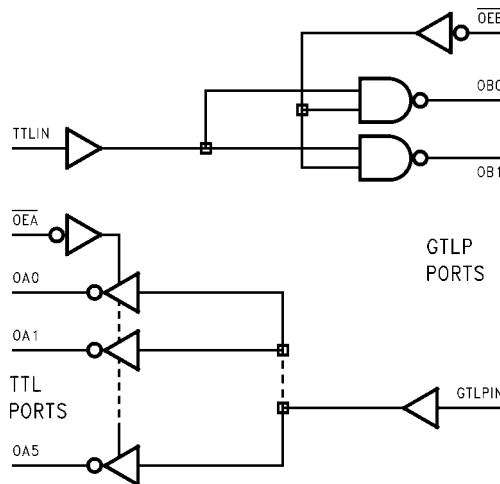

Absolute Maximum Ratings (Note 1)		Recommended Operating Conditions (Note 3)	
Supply Voltage (V_{CC})	-0.5V to +7.0V	Supply Voltage V_{CC}	4.75V to 5.25V
DC Input Voltage (V_I)	-0.5V to +7.0V	Bus Termination Voltage (V_{TT})	
DC Output Voltage (V_O)		GTLP	1.47V to 1.53V
Outputs 3-STATE	-0.5V to +7.0V	V_{REF}	0.98V to 1.02V
Outputs Active (Note 2)	-0.5V to +7.0V	Input Voltage (V_I) on INA Port and Control Pins	0.0V to 5.5V
DC Output Sink Current into OA Port I_{OL}	48 mA	HIGH Level Output Current (I_{OH})	
DC Output Source Current from OA Port I_{OH}	-48 mA	OA Port	-24 mA
DC Output Sink Current into OB Port in the LOW State I_{OL}	80 mA	LOW Level Output Current (I_{OL})	
DC Input Diode Current (I_{IK})		OA Port	+24 mA
$V_I < 0V$	-50 mA	OB Port	+34 mA
DC Output Diode Current (I_{OK})		Operating Temperature (T_A)	-40°C to +85°C
$V_O < 0V$	-50 mA	Note 1: Absolute Maximum continuous ratings are those values beyond which damage to the device may occur. Exposure to these conditions or conditions beyond those indicated may adversely affect device reliability. Functional operation under absolute maximum rated conditions is not implied.	
$V_O > V_{CC}$	+50 mA	Note 2: I_o Absolute Maximum Rating must be observed.	
ESD Rating	> 2000V	Note 3: Unused input must be held HIGH or LOW.	
Storage Temperature (T_{STG})	-65°C to +150°C		

DC Electrical Characteristics

Over Recommended Operating Free-Air Temperature Range, $V_{REF} = 1.0V$ (unless otherwise noted).

Symbol	Test Conditions	Min	Typ (Note 4)	Max	Units	
V_{IH}	GTLPIN	$V_{REF} + 0.05$		V_{TT}	V	
	Others	2.0				
V_{IL}	GTLPIN	0.0		$V_{REF} - 0.05$	V	
	Others			0.8		
V_{REF} (Note 5)	GTLP		1.0		V	
	GTL		0.8			
V_{TT} (Note 5)	GTLP		1.5		V	
	GTL		1.2			
V_{IK}	$V_{CC} = 4.75V$	$I_I = -18 \text{ mA}$		-1.2	V	
V_{OH}	OAn Port	$V_{CC} = 4.75V$	$I_{OH} = -100 \mu A$	$V_{CC} - 0.2$	V	
			$I_{OH} = -18 \text{ mA}$	2.4		
			$I_{OH} = -24 \text{ mA}$	2.2		
V_{OL}	OAn Port	$V_{CC} = 4.75V$	$I_{OL} = 100 \mu A$	0.2	V	
			$I_{OL} = 18 \text{ mA}$	0.4		
			$I_{OL} = 24 \text{ mA}$	0.5		
V_{OL}	OBn Port	$V_{CC} = 4.75V$	$I_{OL} = 100 \mu A$	0.2	V	
			$I_{OL} = 34 \text{ mA}$	0.65		
I_I	TTLIN/Control Pins	$V_{CC} = 5.25V$	$V_I = 5.25V$ $V_I = 0V$	5 -5	μA	
	GTLPIN	$V_{CC} = 5.25V$	$V_I = V_{TT}$ $V_I = 0$	5 -5		
I_{OFF}	TTLIN	$V_{CC} = 0$	V_I or $V_O = 0V$ to 5.25V	100	μA	
I_{OZH}	OAn Port	$V_{CC} = 5.25V$	$V_O = 5.25V$	5	μA	
	OBn Port		$V_O = 1.5V$	5		
I_{OZL}	OAn Port	$V_{CC} = 5.25V$	$V_O = 0$	-5	μA	
I_{CC}	OAn or OBn Ports	$V_{CC} = 5.25V$	Outputs HIGH	7	mA	
			Outputs LOW	7		20
			Outputs Disabled	7		20
ΔI_{CC}	TTLIN	$V_{CC} = 5.25V$	$V_I = V_{CC} - 2.1$	6	mA	

DC Electrical Characteristics (Continued)

Symbol		Test Conditions	Min	Typ (Note 4)	Max	Units
C _{IN}	Control Pins/GTL PIN/ TTLIN	V _I = V _{CC} or 0		3.7		pF
C _{OUT}	OAn Port	V _I = V _{CC} or 0		7		pF
	OBn Port	V _I = V _{CC} or 0		7		

Note 4: All typical values are at V_{CC} = 5.0V and T_A = 25°C.

Note 5: GTLP V_{REF} and V_{TT} are specified to 2% tolerance since signal integrity and noise margin can be significantly degraded if these supplies are noisy. In addition, V_{TT} and R_{TERM} can be adjusted to accommodate backplane impedances other than 50Ω, within the boundaries of not exceeding the DC Absolute I_{OL} ratings. Similarly V_{REF} can be adjusted to compensate for changes in V_{TT}.

AC Electrical Characteristics

Over recommended range of supply voltage and operating free air temperature. V_{REF} = 1.0V (unless otherwise noted).
 C_L = 30 pF for OBn Port and C_L = 50 pF for OAn Port.

Symbol	From (Input)	To (Output)	Min	Typ (Note 6)	Max	Units
t _{PLH}	TTLIN	OBn	1.5	3.8	6.0	ns
t _{PHL}			1.5	2.8	5.0	
t _{PLH}	$\overline{\text{OEB}}$	OBn	1.5	6.4	10.5	ns
t _{PHL}			1.5	3.2	6.0	
t _{RISE}	Transition Time, OB Outputs (20% to 80%)			2.3		ns
t _{FALL}	Transition Time, OB outputs (20% to 80%)			2.3		ns
t _{RISE}	Transition Time, OA outputs (10% to 90%)			2.0		ns
t _{FALL}	Transition Time, OA outputs (10% to 90%)			2.0		ns
t _{PZH} , t _{PZL}	$\overline{\text{OEA}}$	OAn	0.5	3.6	6.5	ns
t _{PLZ} , t _{PHZ}			0.5	3.8	6.5	
t _{PLH}	GTL PIN	OAn	1.5	4.4	6.5	ns
t _{PHL}			1.5	4.0	6.0	
t _{OSHL} , t _{OSLH} (Note 7)	Common Edge Skew			0.2	1.0	ns

Note 6: All typical values are at V_{CC} = 5.0V and T_A = 25°C.

Note 7: Skew specs are given for specific worst case V_{CC} Temp. Skew values between the OBn outputs could vary on the backplane due to loading and impedance seen by the device.

Test Circuit and Timing Waveforms

Test Circuit for A Outputs

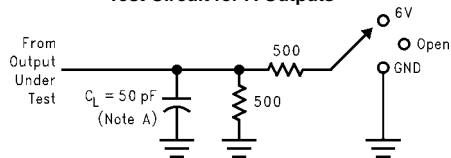

Test	S
t_{PLH}/t_{PHL}	Open
t_{PLZ}/t_{PZL}	6V
t_{PHZ}/t_{PZH}	GND

Note A: C_L includes probes and jig capacitance.

Test Circuit for B Outputs

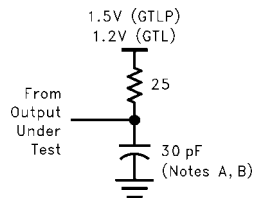

Note A: C_L includes probes and jig capacitance.
Note B: For B Port $C_L = 30 \text{ pF}$ is used for worst case.

Voltage Waveforms Enable and Disable Times A Port

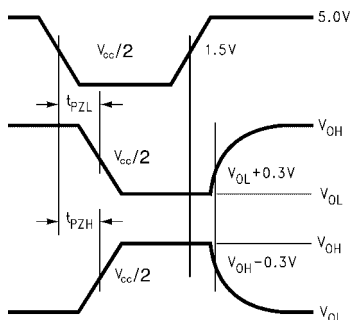

Voltage Waveforms Propagation Delay ($V_m = V_{CC}/2$ for A Port and 1.0 for B Port)

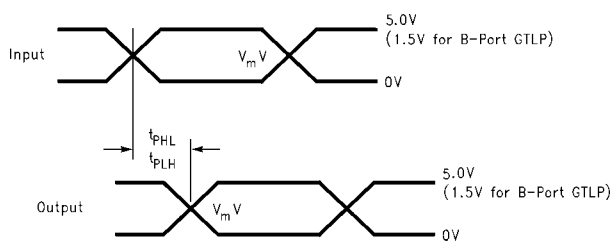

Physical Dimensions inches (millimeters) unless otherwise noted

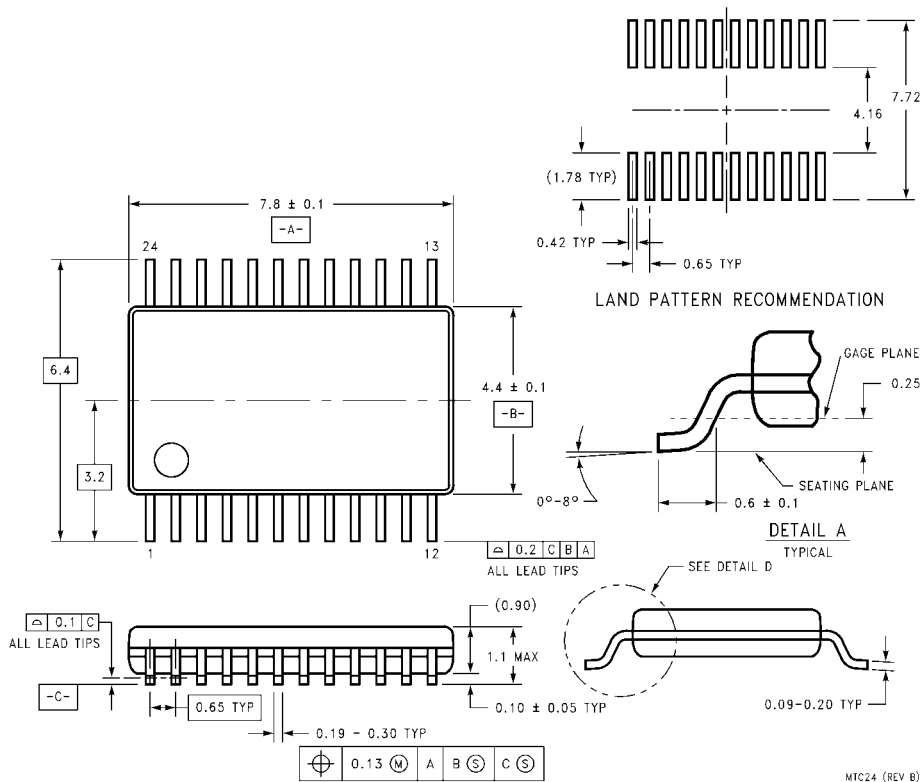

**24-Lead Thin Shrink Small Outline Package (TSSOP), JEDEC MO-153, 4.4mm Wide
Package Number MTC24**

Fairchild does not assume any responsibility for use of any circuitry described, no circuit patent licenses are implied and Fairchild reserves the right at any time without notice to change said circuitry and specifications.

LIFE SUPPORT POLICY

FAIRCHILD'S PRODUCTS ARE NOT AUTHORIZED FOR USE AS CRITICAL COMPONENTS IN LIFE SUPPORT DEVICES OR SYSTEMS WITHOUT THE EXPRESS WRITTEN APPROVAL OF THE PRESIDENT OF FAIRCHILD SEMICONDUCTOR CORPORATION. As used herein:

1. Life support devices or systems are devices or systems which, (a) are intended for surgical implant into the body, or (b) support or sustain life, and (c) whose failure to perform when properly used in accordance with instructions for use provided in the labeling, can be reasonably expected to result in a significant injury to the user.
2. A critical component in any component of a life support device or system whose failure to perform can be reasonably expected to cause the failure of the life support device or system, or to affect its safety or effectiveness.

www.fairchildsemi.com