

PNP Silicon Darlington Transistors

BC 876
... BC 880

- High current gain
- High collector current
- Low collector-emitter saturation voltage
- Complementary types: BC 875, BC 877, BC 879 (NPN)

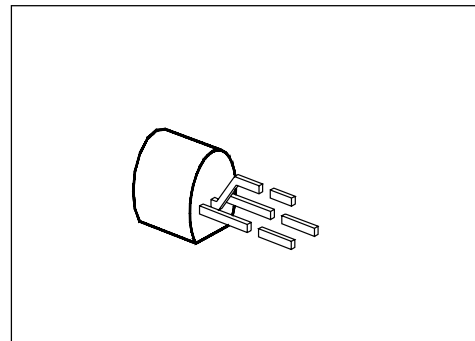

Type	Marking	Ordering Code	Pin Configuration			Package ¹⁾
			1	2	3	
BC 876 BC 878 BC 880	–	C62702-C943 C62702-C942 C62702-C941	E	C	B	TO-92

Maximum Ratings

Parameter	Symbol	Values			Unit
		BC 876	BC 878	BC 880	
Collector-emitter voltage	V_{CE0}	45	60	80	V
Collector-base voltage	V_{CB0}	60	80	100	
Emitter-base voltage	V_{EB0}	5			
Collector current	I_C	1			A
Peak collector current	I_{CM}	2			
Base current	I_B	100			mA
Peak base current	I_{BM}	200			
Total power dissipation, $T_C = 90\text{ °C}^2)$	P_{tot}	0.8 (1)			W
Junction temperature	T_j	150			°C
Storage temperature range	T_{stg}	– 65 ... + 150			

Thermal Resistance

Junction - ambient ²⁾	$R_{th JA}$	≤ 156	K/W
Junction - case ³⁾	$R_{th JC}$	≤ 75	

1) For detailed information see chapter Package Outlines.

2) If transistors with max. 4 mm lead length are fixed on PCBs with a min. 10 mm × 10 mm large copper area for the collector terminal, $R_{thJA} = 125\text{ K/W}$ and thus $P_{tot max} = 1\text{ W}$ at $T_A = 25\text{ °C}$.

3) Mounted on Al heat sink 15 mm × 25 mm × 0.5 mm.

Electrical Characteristics

at $T_A = 25\text{ °C}$, unless otherwise specified.

Parameter	Symbol	Values			Unit
		min.	typ.	max.	

DC characteristics

Collector-emitter breakdown voltage $I_C = 50\text{ mA}$	$V_{(BR)CE0}$				V
BC 876		45	–	–	
BC 878		60	–	–	
BC 880		80	–	–	
Collector-base breakdown voltage $I_C = 100\text{ }\mu\text{A}$	$V_{(BR)CB0}$				
BC 876		60	–	–	
BC 878		80	–	–	
BC 880		100	–	–	
Emitter-base breakdown voltage, $I_E = 100\text{ }\mu\text{A}$	$V_{(BR)EB0}$	5	–	–	
Collector cutoff current $V_{CE} = 0.5 \times V_{CEmax}$	I_{CE0}	–	–	500	
Collector cutoff current $V_{CB} = V_{CBmax}$ $V_{CB} = V_{CBmax}, T_A = 150\text{ °C}$	I_{CB0}	–	–	100 20	nA μA
Emitter cutoff current, $V_{EB} = 4\text{ V}$	I_{EB0}	–	–	100	nA
DC current gain $I_C = 150\text{ mA}; V_{CE} = 10\text{ V}^1)$ $I_C = 500\text{ mA}; V_{CE} = 10\text{ V}^1)$	h_{FE}	1000 2000	– –	– –	–
Collector-emitter saturation voltage ¹⁾ $I_C = 500\text{ mA}, I_B = 0.5\text{ mA}$ $I_C = 1000\text{ mA}, I_B = 1\text{ mA}$	V_{CEsat}	– –	– –	1.3 1.8	V
Base-emitter saturation voltage ¹⁾ $I_C = 1000\text{ mA}; I_B = 1\text{ mA}$	V_{BEsat}	–	–	2.2	

AC characteristics

Transition frequency $I_C = 200\text{ mA}, V_{CE} = 5\text{ V}, f = 20\text{ MHz}$	f_T	–	150	–	MHz
---	-------	---	-----	---	-----

¹⁾ Pulse test: $t \leq 300\text{ }\mu\text{s}, D \leq 2\%$.

Total power dissipation $P_{tot} = f(T_A; T_C)$

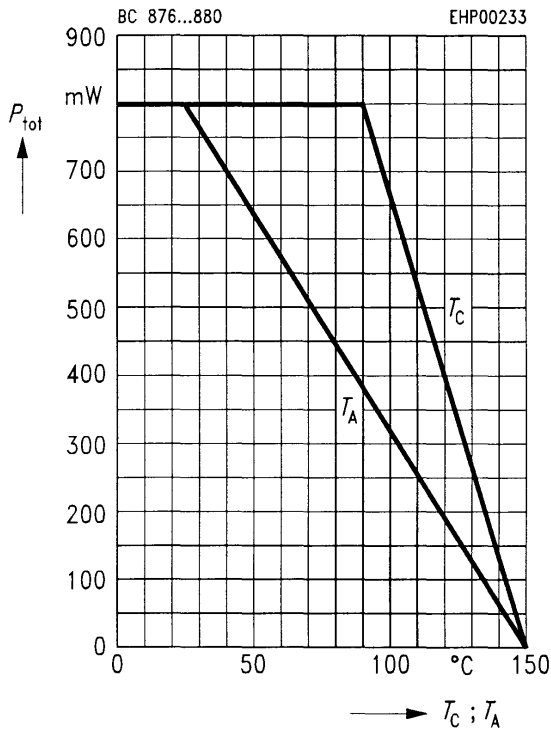

Collector cutoff current $I_{CB0} = f(T_A)$

$V_{CB} = 100$ V

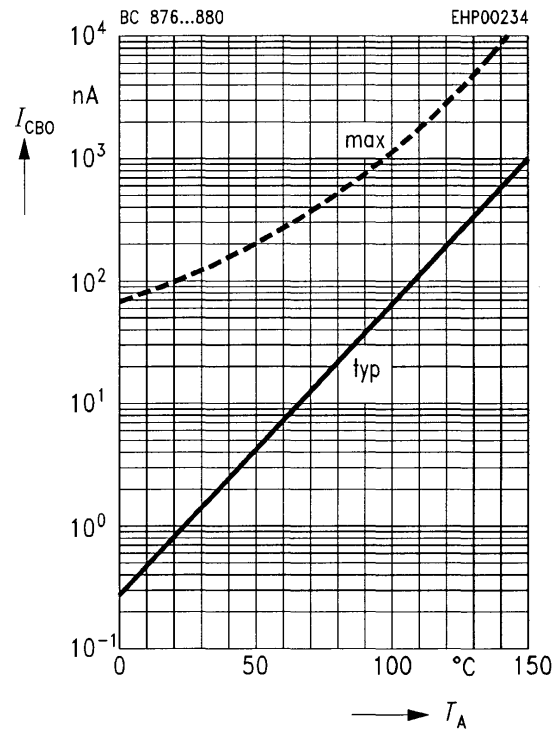

Permissible pulse load $R_{thJA} = f(t_p)$

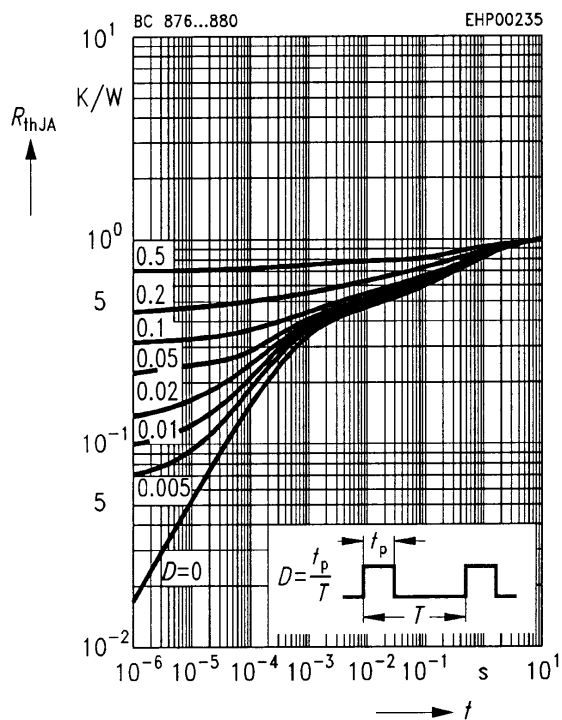

DC current gain $h_{FE} = f(T_A)$

$V_{CE} = 10$ V

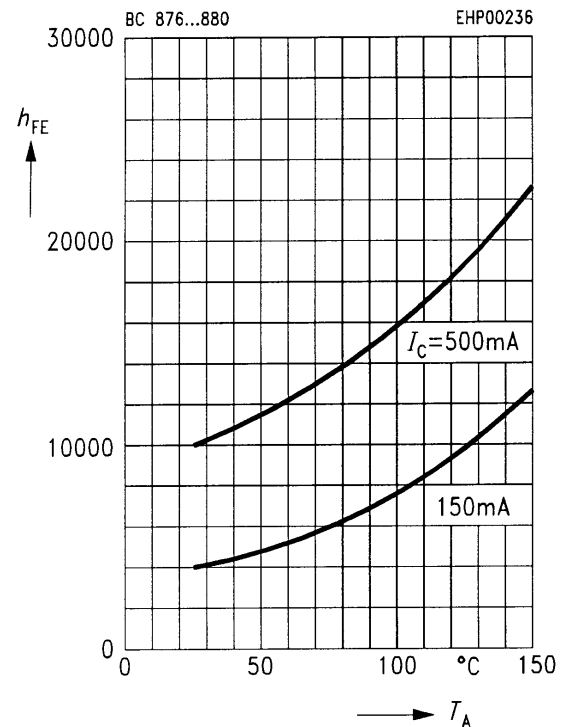

DC current gain $h_{FE} = f(I_C)$
 $V_{CE} = 10 \text{ V}, T_A = 25 \text{ }^\circ\text{C}$

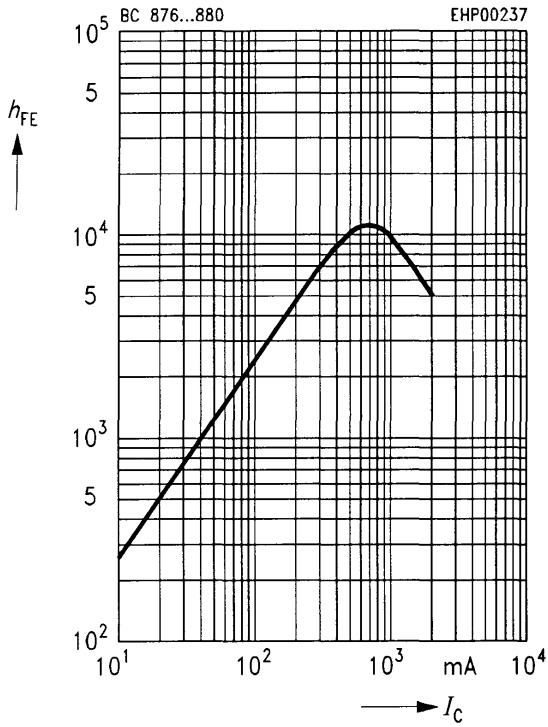

Transition frequency $f_T = f(I_C)$
 $V_{CE} = 5 \text{ V}, f = 20 \text{ MHz}$

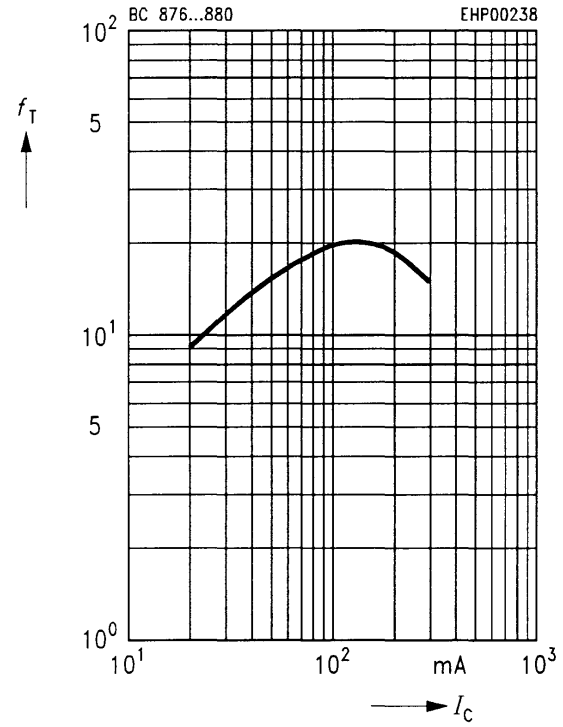

Collector-emitter saturation voltage
 $V_{CEsat} = f(I_C)$
 Parameter = $I_B, T_A = 25 \text{ }^\circ\text{C}$

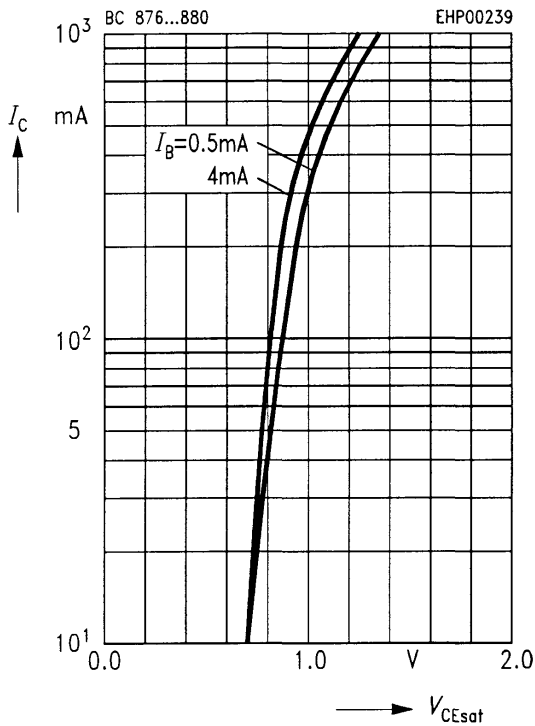

Base-emitter saturation voltage
 $V_{BEsat} = f(I_C)$
 Parameter = $I_B, T_A = 25 \text{ }^\circ\text{C}$

