

BSS84LT1

Power MOSFET 130 mA, 50 V P-Channel SOT-23

These miniature surface mount MOSFETs reduce power loss conserve energy, making this device ideal for use in small power management circuitry. Typical applications are DC-DC converters, load switching, power management in portable and battery-powered products such as computers, printers, cellular and cordless telephones.

Features

- Energy Efficient
- Miniature SOT-23 Surface Mount Package Saves Board Space
- Pb-Free Package is Available

MAXIMUM RATINGS ($T_J = 25^\circ\text{C}$ unless otherwise noted)

Rating	Symbol	Value	Unit
Drain-to-Source Voltage	V_{DSS}	50	Vdc
Gate-to-Source Voltage – Continuous	V_{GS}	± 20	Vdc
Drain Current			mA
– Continuous @ $T_A = 25^\circ\text{C}$	I_D	130	
– Pulsed Drain Current ($t_p \leq 10 \mu\text{s}$)	I_{DM}	520	
Total Power Dissipation @ $T_A = 25^\circ\text{C}$	P_D	225	mW
Operating and Storage Temperature Range	T_J, T_{stg}	- 55 to 150	$^\circ\text{C}$
Thermal Resistance – Junction-to-Ambient	$R_{\theta JA}$	556	$^\circ\text{C}/\text{W}$
Maximum Lead Temperature for Soldering Purposes, for 10 seconds	T_L	260	$^\circ\text{C}$

Maximum ratings are those values beyond which device damage can occur. Maximum ratings applied to the device are individual stress limit values (not normal operating conditions) and are not valid simultaneously. If these limits are exceeded, device functional operation is not implied, damage may occur and reliability may be affected.



ON Semiconductor®

<http://onsemi.com>

130 mA, 50 V $R_{DS(on)} = 10 \Omega$

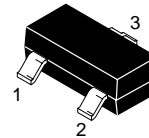
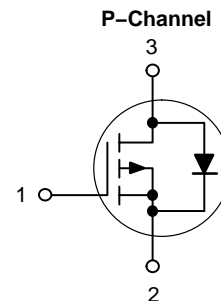

**SOT-23
CASE 318
STYLE 21**

MARKING DIAGRAM & PIN ASSIGNMENT

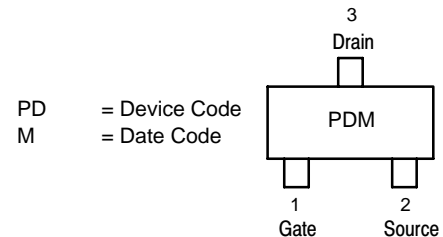

ORDERING INFORMATION

Device	Package	Shipping†
BSS84LT1	SOT-23	3000 Tape & Reel
BSS84LT1G	SOT-23 (Pb-Free)	3000 Tape & Reel

†For information on tape and reel specifications, including part orientation and tape sizes, please refer to our Tape and Reel Packaging Specifications Brochure, BRD8011/D.

BSS84LT1

ELECTRICAL CHARACTERISTICS (T_A = 25°C unless otherwise noted)

Characteristic	Symbol	Min	Typ	Max	Unit
----------------	--------	-----	-----	-----	------

OFF CHARACTERISTICS

Drain-to-Source Breakdown Voltage (V _{GS} = 0 Vdc, I _D = 250 μAdc)	V _{(BR)DSS}	50	-	-	Vdc
Zero Gate Voltage Drain Current (V _{DS} = 25 Vdc, V _{GS} = 0 Vdc) (V _{DS} = 50 Vdc, V _{GS} = 0 Vdc) (V _{DS} = 50 Vdc, V _{GS} = 0 Vdc, T _J = 125°C)	I _{DSS}	-	-	0.1 15 60	μAdc
Gate-Body Leakage Current (V _{GS} = ± 20 Vdc, V _{DS} = 0 Vdc)	I _{GSS}	-	-	±10	nAdc

ON CHARACTERISTICS (Note 1)

Gate-Source Threshold Voltage (V _{DS} = V _{GS} , I _D = 250 μA)	V _{GS(th)}	0.9	-	2.0	Vdc
Static Drain-to-Source On-Resistance (V _{GS} = 5.0 Vdc, I _D = 100 mAdc)	R _{DS(on)}	-	5.0	10	Ω
Transfer Admittance (V _{DS} = 25 Vdc, I _D = 100 mAdc, f = 1.0 kHz)	y _{fs}	50	-	-	mS

DYNAMIC CHARACTERISTICS

Input Capacitance	V _{DS} = 5.0 Vdc	C _{iss}	-	30	-	pF
Output Capacitance	V _{DS} = 5.0 Vdc	C _{oss}	-	10	-	
Transfer Capacitance	V _{DG} = 5.0 Vdc	C _{rfs}	-	5.0	-	

SWITCHING CHARACTERISTICS (Note 2)

Turn-On Delay Time	V _{DD} = -15 Vdc, I _D = -2.5 Adc, R _L = 50 Ω	t _{d(on)}	-	2.5	-	ns
Rise Time		t _r	-	1.0	-	
Turn-Off Delay Time		t _{d(off)}	-	16	-	
Fall Time		t _f	-	8.0	-	
Gate Charge		Q _T	-	6000	-	pC

SOURCE-DRAIN DIODE CHARACTERISTICS

Continuous Current		I _S	-	-	0.130	A
Pulsed Current		I _{SM}	-	-	0.520	
Forward Voltage (Note 2)	V _{GS} = 0 V, I _S = 130 mA	V _{SD}	-	-	2.2	V

1. Pulse Test: Pulse Width ≤ 300 μs, Duty Cycle ≤ 2%.
2. Switching characteristics are independent of operating junction temperature.

TYPICAL ELECTRICAL CHARACTERISTICS

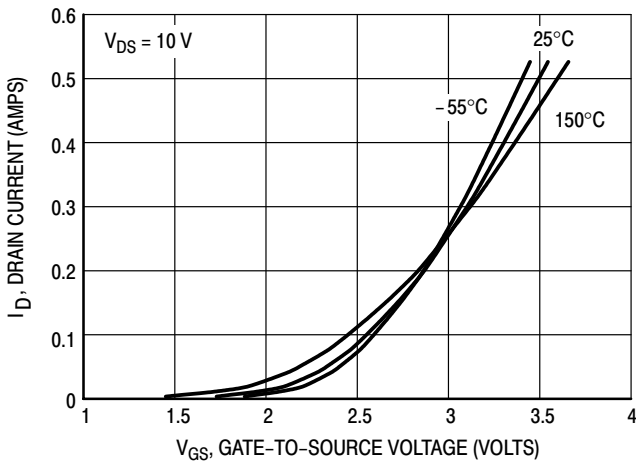

Figure 1. Transfer Characteristics

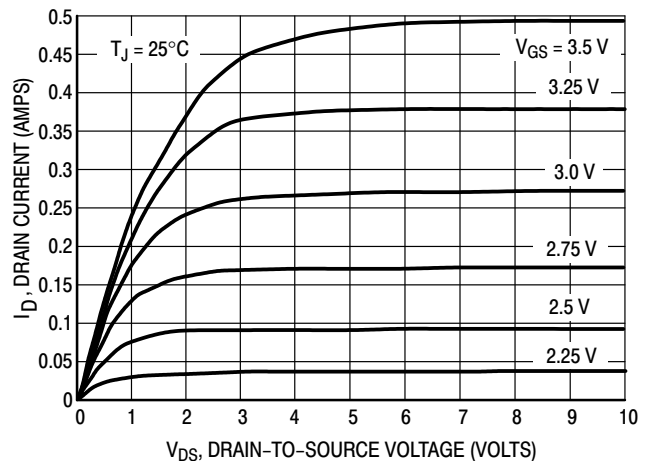

Figure 2. On-Region Characteristics

BSS84LT1

TYPICAL ELECTRICAL CHARACTERISTICS

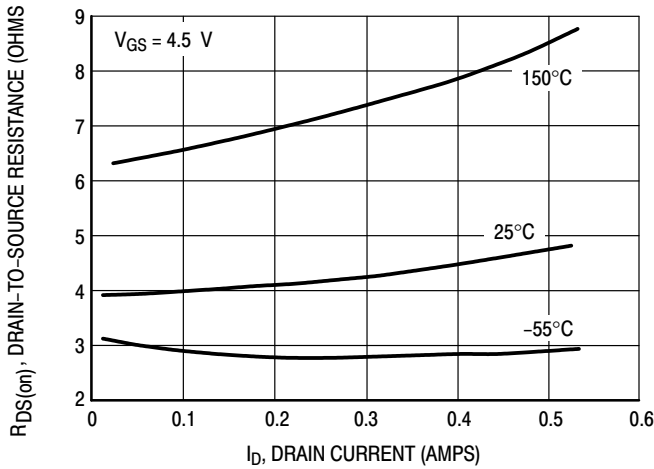

Figure 3. On-Resistance versus Drain Current

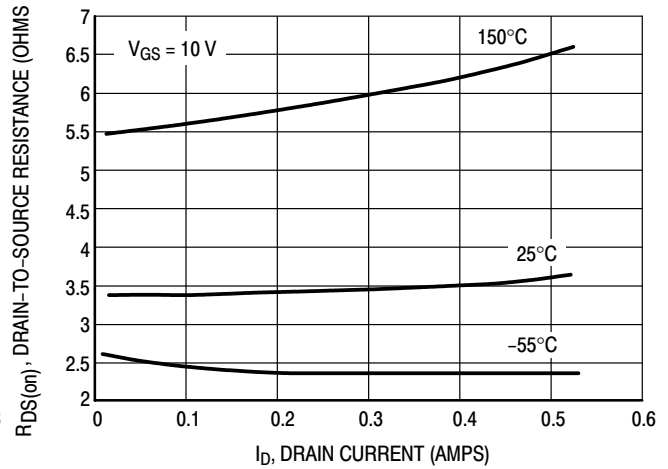

Figure 4. On-Resistance versus Drain Current

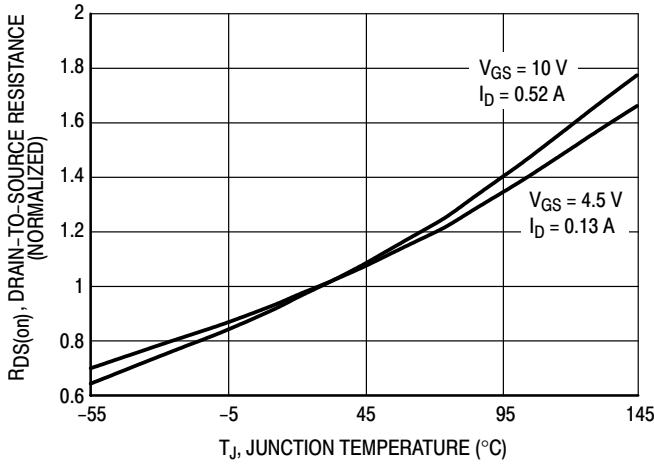

Figure 5. On-Resistance Variation with Temperature

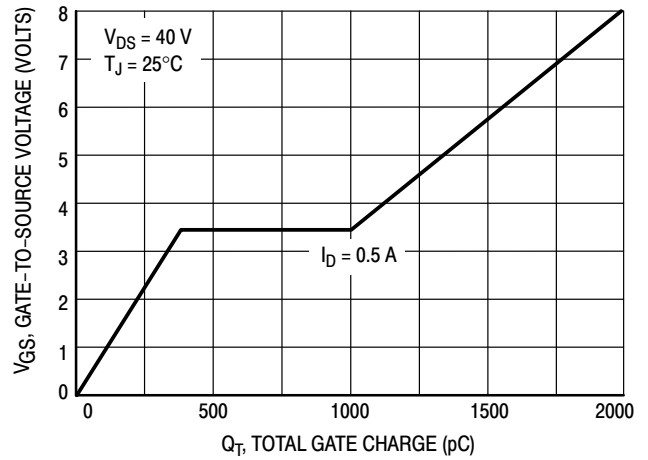

Figure 6. Gate Charge

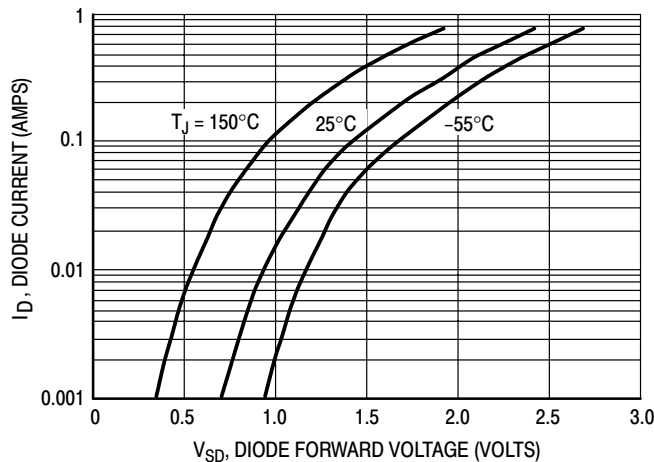
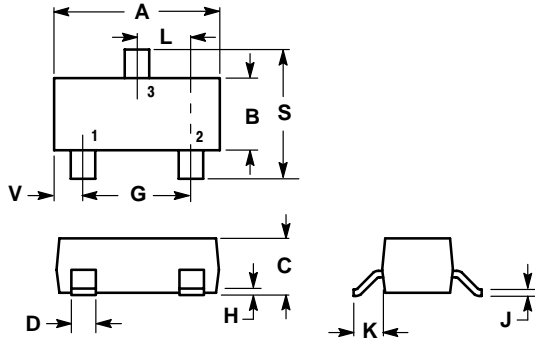

Figure 7. Body Diode Forward Voltage

BSS84LT1

PACKAGE DIMENSIONS

SOT-23 (TO-236)
CASE 318-08
ISSUE AH



NOTES:

1. DIMENSIONING AND TOLERANCING PER ANSI Y14.5M, 1982.
2. CONTROLLING DIMENSION: INCH.
3. MAXIMUM LEAD THICKNESS INCLUDES LEAD FINISH THICKNESS. MINIMUM LEAD THICKNESS IS THE MINIMUM THICKNESS OF BASE MATERIAL.
4. 318-03 AND -07 OBSOLETE, NEW STANDARD 318-08.

DIM	INCHES		MILLIMETERS	
	MIN	MAX	MIN	MAX
A	0.1102	0.1197	2.80	3.04
B	0.0472	0.0551	1.20	1.40
C	0.0350	0.0440	0.89	1.11
D	0.0150	0.0200	0.37	0.50
G	0.0701	0.0807	1.78	2.04
H	0.0005	0.0040	0.013	0.100
J	0.0034	0.0070	0.085	0.177
K	0.0140	0.0285	0.35	0.69
L	0.0350	0.0401	0.89	1.02
S	0.0830	0.1039	2.10	2.64
V	0.0177	0.0236	0.45	0.60

STYLE 21:

1. GATE
2. SOURCE
3. DRAIN

SOLDERING FOOTPRINT*

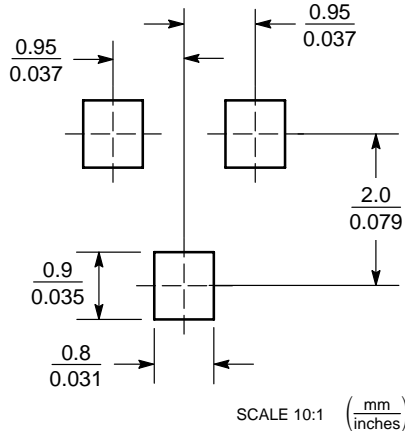

*For additional information on our Pb-Free strategy and soldering details, please download the ON Semiconductor Soldering and Mounting Techniques Reference Manual, SOLDERRM/D.

ON Semiconductor and are registered trademarks of Semiconductor Components Industries, LLC (SCILLC). SCILLC reserves the right to make changes without further notice to any products herein. SCILLC makes no warranty, representation or guarantee regarding the suitability of its products for any particular purpose, nor does SCILLC assume any liability arising out of the application or use of any product or circuit, and specifically disclaims any and all liability, including without limitation special, consequential or incidental damages. "Typical" parameters which may be provided in SCILLC data sheets and/or specifications can and do vary in different applications and actual performance may vary over time. All operating parameters, including "Typicals" must be validated for each customer application by customer's technical experts. SCILLC does not convey any license under its patent rights nor the rights of others. SCILLC products are not designed, intended, or authorized for use as components in systems intended for surgical implant into the body, or other applications intended to support or sustain life, or for any other application in which the failure of the SCILLC product could create a situation where personal injury or death may occur. Should Buyer purchase or use SCILLC products for any such unintended or unauthorized application, Buyer shall indemnify and hold SCILLC and its officers, employees, subsidiaries, affiliates, and distributors harmless against all claims, costs, damages, and expenses, and reasonable attorney fees arising out of, directly or indirectly, any claim of personal injury or death associated with such unintended or unauthorized use, even if such claim alleges that SCILLC was negligent regarding the design or manufacture of the part. SCILLC is an Equal Opportunity/Affirmative Action Employer. This literature is subject to all applicable copyright laws and is not for resale in any manner.

PUBLICATION ORDERING INFORMATION

LITERATURE FULFILLMENT:

Literature Distribution Center for ON Semiconductor
P.O. Box 61312, Phoenix, Arizona 85082-1312 USA
Phone: 480-829-7710 or 800-344-3860 Toll Free USA/Canada
Fax: 480-829-7709 or 800-344-3867 Toll Free USA/Canada
Email: orderlit@onsemi.com

N. American Technical Support: 800-282-9855 Toll Free
USA/Canada

Japan: ON Semiconductor, Japan Customer Focus Center
2-9-1 Kamimeguro, Meguro-ku, Tokyo, Japan 153-0051
Phone: 81-3-5773-3850

ON Semiconductor Website: <http://onsemi.com>

Order Literature: <http://www.onsemi.com/litorder>

For additional information, please contact your local Sales Representative.