

# BB505M

## Build in Biasing Circuit MOS FET IC UHF RF Amplifier

REJ03G0365-0100Z

Rev.1.00

Jun.14.2004

### Features

- Build in Biasing Circuit; To reduce using parts cost & PC board space.
- Low noise; NF = 1.5 dB typ. at f = 900 MHz
- High gain; PG = 24 dB typ. at f = 900 MHz
- Withstanding to ESD;  
Build in ESD absorbing diode. Withstand up to 190 V at C = 200 pF, Rs = 0 conditions.
- Provide mini mold packages; MPAK-4 (SOT-143mod)

### Outline

MPAK-4

1. Source  
2. Gate1  
3. Gate2  
4. Drain

Notes: 1. Marking is "ES-".  
2. BB505M is individual type number of RENESAS BBFET.

### Absolute Maximum Ratings

(Ta = 25°C)

Item	Symbol	Ratings	Unit
Drain to source voltage	$V_{DS}$	6	V
Gate1 to source voltage	$V_{G1S}$	+6 -0	V
Gate2 to source voltage	$V_{G2S}$	+6 -0	V
Drain current	$I_D$	20	mA
Channel power dissipation	$P_{ch}^{note3}$	300	mW
Channel temperature	$T_{ch}$	150	°C
Storage temperature	$T_{stg}$	-55 to +150	°C

Notes: 3. Value on the glass epoxy board (50 mm × 40 mm × 1 mm ).

Electrical Characteristics

(Ta = 25°C)

Item	Symbol	Min	Typ	Max	Unit	Test Conditions
Drain to source breakdown voltage	$V_{(BR)DSS}$	6	—	—	V	$I_D = 200 \mu A, V_{G1S} = V_{G2S} = 0$
Gate1 to source breakdown voltage	$V_{(BR)G1SS}$	+6	—	—	V	$I_{G1} = +10 \mu A, V_{G2S} = V_{DS} = 0$
Gate2 to source breakdown voltage	$V_{(BR)G2SS}$	+6	—	—	V	$I_{G2} = +10 \mu A, V_{G1S} = V_{DS} = 0$
Gate1 to source cutoff current	$I_{G1SS}$	—	—	+100	nA	$V_{G1S} = +5 V, V_{G2S} = V_{DS} = 0$
Gate2 to source cutoff current	$I_{G2SS}$	—	—	+100	nA	$V_{G2S} = +5 V, V_{G1S} = V_{DS} = 0$
Gate1 to source cutoff voltage	$V_{G1S(off)}$	0.5	0.7	1.0	V	$V_{DS} = 5 V, V_{G2S} = 4 V, I_D = 100 \mu A$
Gate2 to source cutoff voltage	$V_{G2S(off)}$	0.5	0.7	1.0	V	$V_{DS} = 5 V, V_{G1S} = 5 V, I_D = 100 \mu A$
Drain current	$I_{D(op)}$	7	11	15	mA	$V_{DS} = 5 V, V_{G1} = 5 V, V_{G2S} = 4 V$ $R_G = 220 k\Omega$
Forward transfer admittance	$ y_{fs} $	28	33	38	mS	$V_{DS} = 5 V, V_{G1} = 5 V, V_{G2S} = 4 V$ $R_G = 220 k\Omega, f = 1 kHz$
Input capacitance	$C_{iss}$	1.4	1.75	2.1	pF	$V_{DS} = 5 V, V_{G1} = 5 V, V_{G2S} = 4 V$ $R_G = 220 k\Omega, f = 1 MHz$
Output capacitance	$C_{oss}$	1.0	1.4	1.8	pF	
Reverse transfer capacitance	$C_{rss}$	—	0.03	0.05	pF	
Power gain	PG	19	24	29	dB	$V_{DS} = 5 V, V_{G1} = 5 V, V_{G2S} = 4 V$
Noise figure	NF	—	1.5	2.2	dB	$R_G = 220 k\Omega, f = 900 MHz$

Bias Circuit for Operating Items ( $I_{D(op)}$ ,  $|y_{fs}|$ ,  $C_{iss}$ ,  $C_{oss}$ ,  $C_{rss}$ , NF, PG)

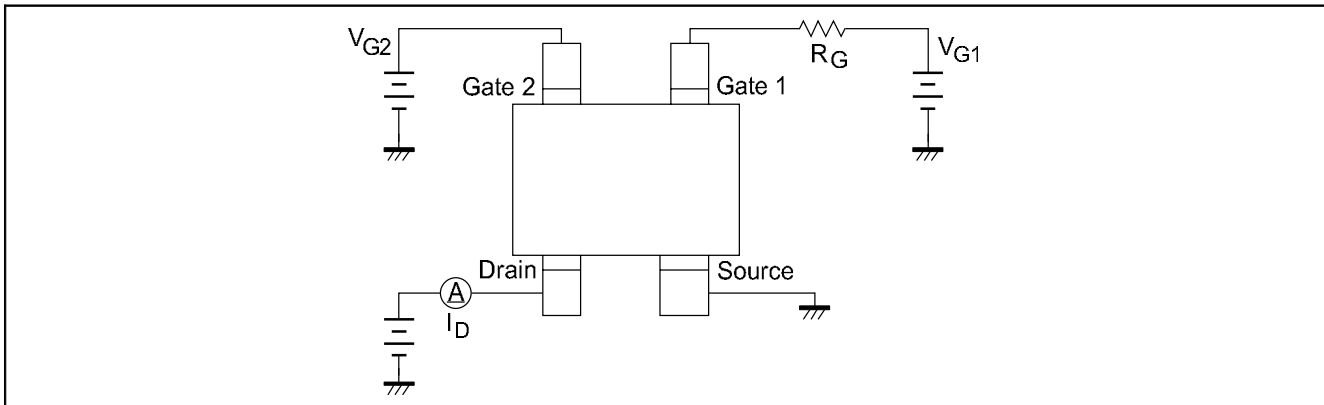

900 MHz Power Gain, Noise Figure Test Circuit

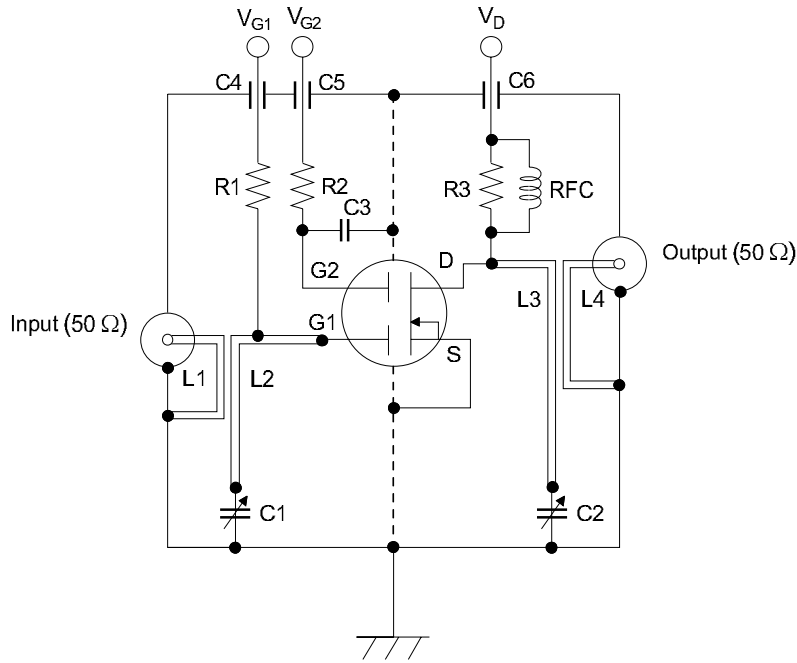

- C1, C2 : Variable Capacitor (10 pF MAX)
- C3 : Disk Capacitor (1000 pF)
- C4 to C6 : Air Capacitor (1000 pF)
- R1 : 220 kΩ
- R2 : 47 kΩ
- R3 : 4.7 kΩ

L1:

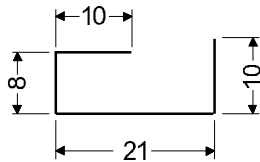

L2:

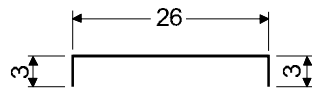

(φ1mm Copper wire)  
Unit : mm

L3:

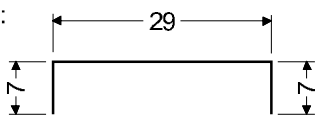

L4:

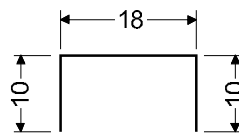

RFC : φ1mm Copper wire with enamel 4 turns inside dia 6 mm

Main Characteristics

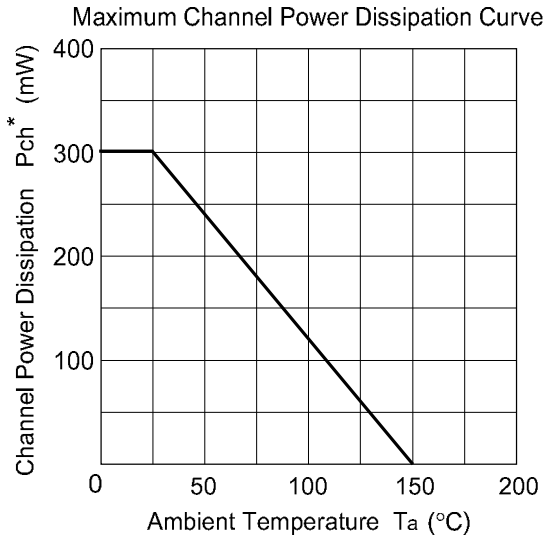

\* Value on the glass epoxy board (50mm × 40mm × 1mm)

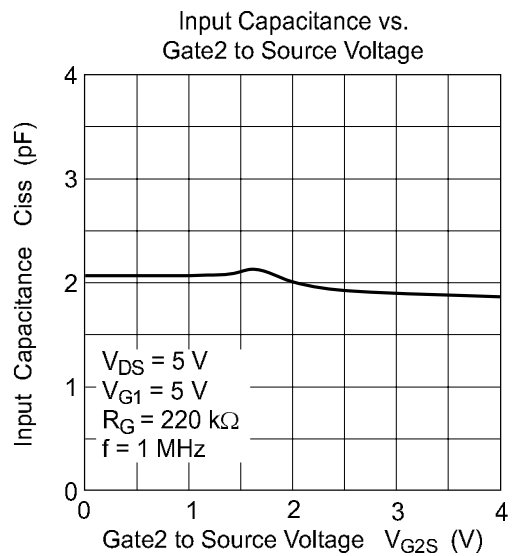
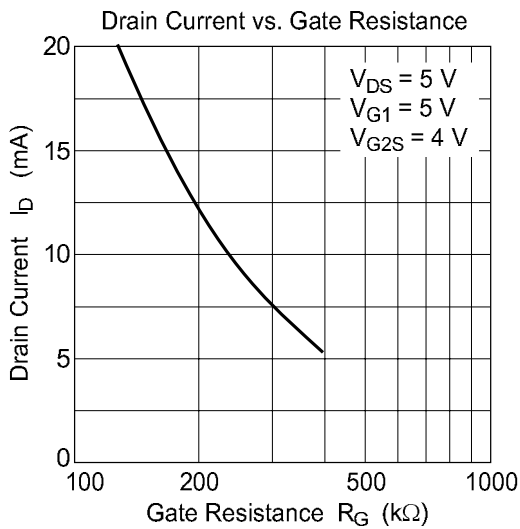
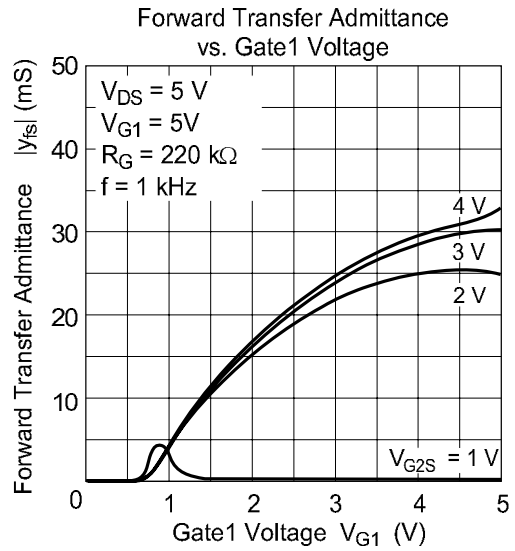
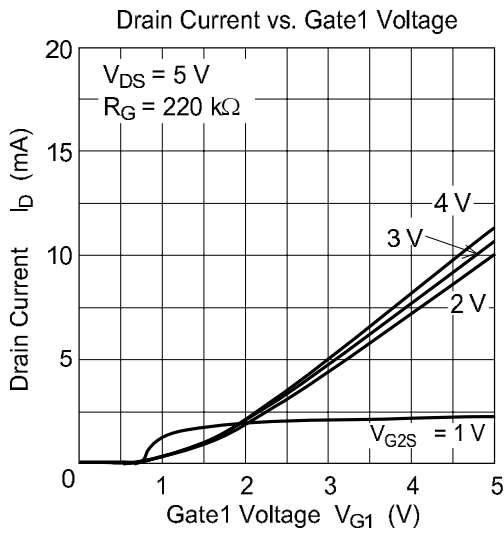
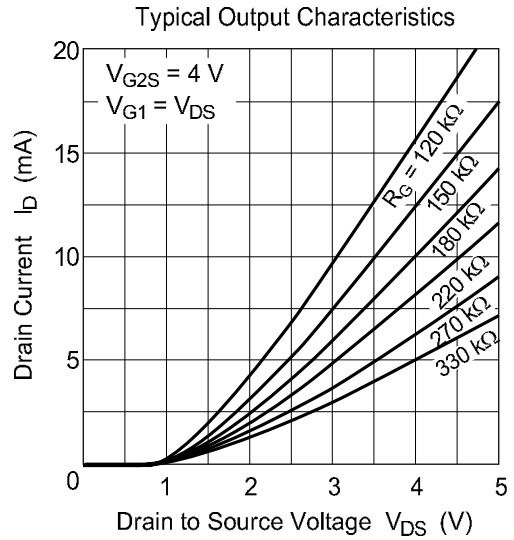

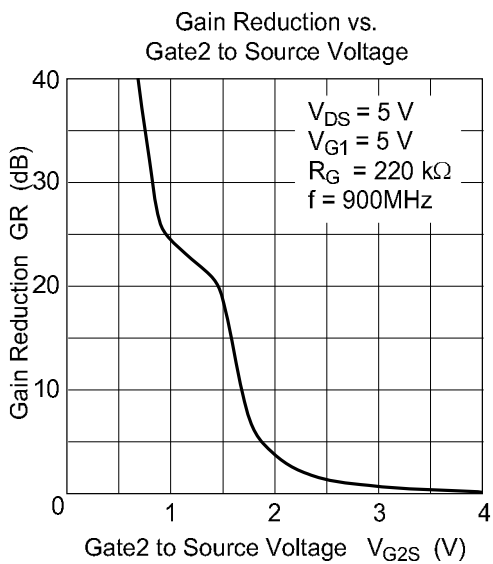
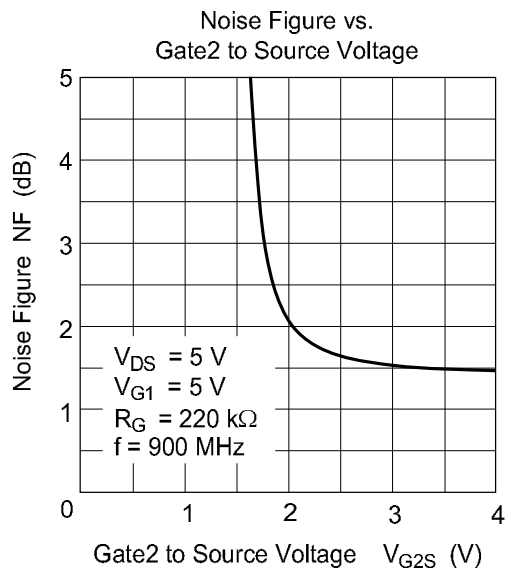
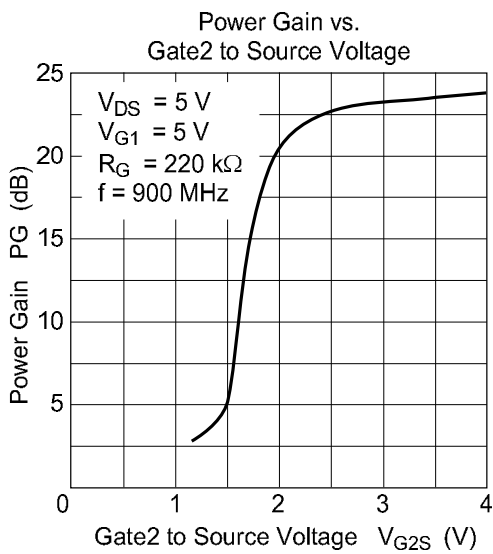
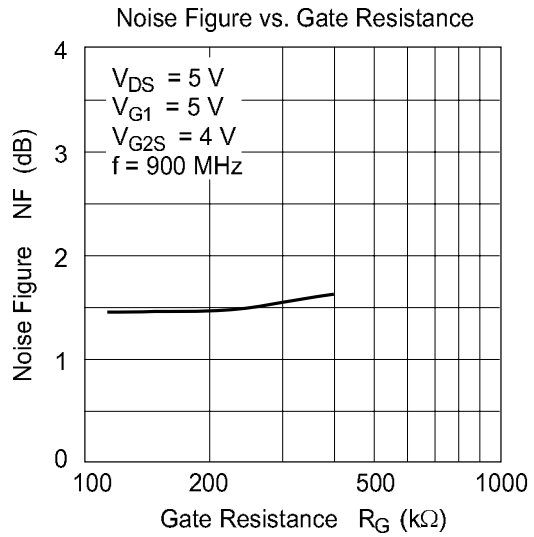
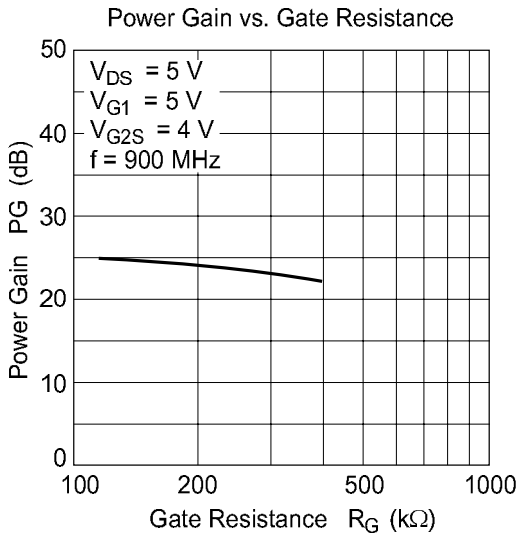

S<sub>11</sub> Parameter vs. Frequency

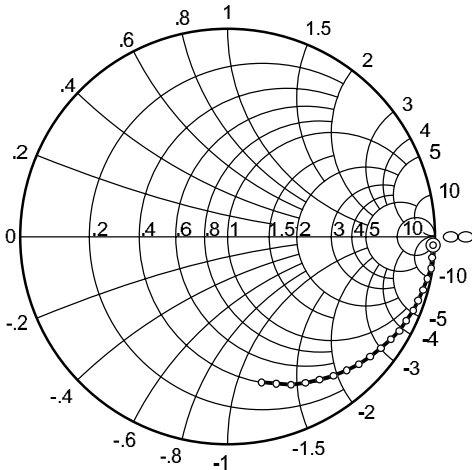

Condition:  $V_{DS} = 5\text{ V}$ ,  $V_{G1} = 5\text{ V}$ ,  $V_{G2S} = 4\text{ V}$   
 $R_G = 220\text{ k}\Omega$ ,  $Z_o = 50\ \Omega$   
 50 to 1000 MHz (50 MHz Step)

S<sub>21</sub> Parameter vs. Frequency

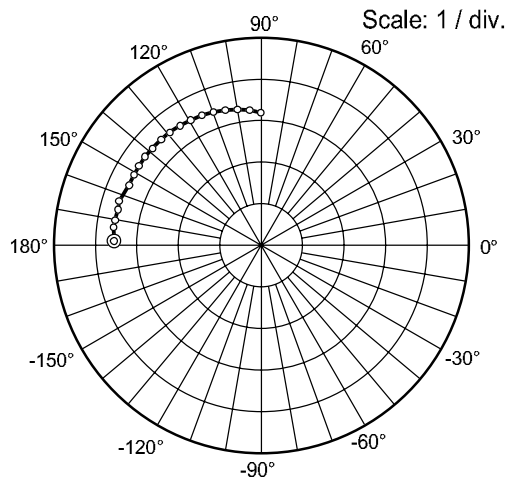

Condition:  $V_{DS} = 5\text{ V}$ ,  $V_{G1} = 5\text{ V}$ ,  $V_{G2S} = 4\text{ V}$   
 $R_G = 220\text{ k}\Omega$ ,  $Z_o = 50\ \Omega$   
 50 to 1000 MHz (50 MHz Step)

S<sub>12</sub> Parameter vs. Frequency

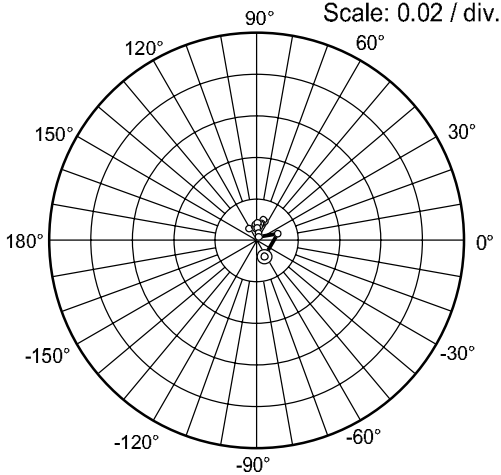

Condition:  $V_{DS} = 5\text{ V}$ ,  $V_{G1} = 5\text{ V}$ ,  $V_{G2S} = 4\text{ V}$   
 $R_G = 220\text{ k}\Omega$ ,  $Z_o = 50\ \Omega$   
 50 to 1000 MHz (50 MHz Step)

S<sub>22</sub> Parameter vs. Frequency

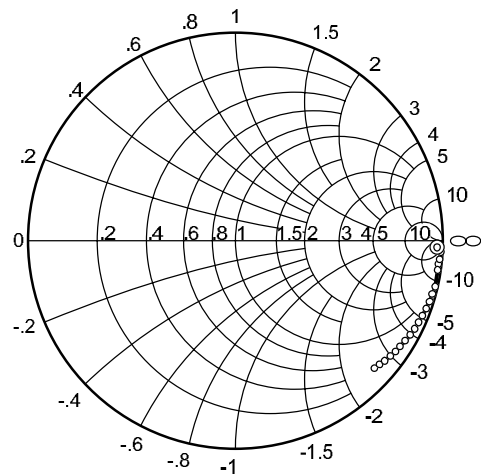

Condition:  $V_{DS} = 5\text{ V}$ ,  $V_{G1} = 5\text{ V}$ ,  $V_{G2S} = 4\text{ V}$   
 $R_G = 220\text{ k}\Omega$ ,  $Z_o = 50\ \Omega$   
 50 to 1000 MHz (50 MHz Step)

## S parameter

 $(V_{DS} = 5 \text{ V}, V_{G1} = 5 \text{ V}, V_{G2S} = 4 \text{ V}, R_G = 200 \text{ k}\Omega, Z_O = 50 \Omega)$ 

f (MHz)	S11		S21		S12		S22	
	MAG	ANG	MAG	ANG	MAG	ANG	MAG	ANG
50	0.991	-2.4	3.55	178.2	0.009	-64.5	0.976	-1.8
100	0.991	-5.9	3.58	172.9	0.011	18.0	0.995	-3.1
150	0.993	-8.9	3.58	170.2	0.002	61.4	0.990	-5.2
200	0.983	-11.9	3.56	165.9	0.004	77.7	0.986	-6.5
250	0.977	-15.3	3.59	162.6	0.006	87.6	0.986	-8.2
300	0.969	-18.5	3.50	155.5	0.008	87.8	0.990	-12.9
350	0.962	-21.6	3.51	151.0	0.006	94.6	0.984	-15.1
400	0.952	-25.2	3.52	146.9	0.007	80.9	0.982	-17.3
450	0.944	-28.7	3.52	142.6	0.008	87.1	0.977	-19.5
500	0.929	-32.2	3.51	138.2	0.008	78.1	0.973	-21.8
550	0.914	-36.0	3.51	133.4	0.008	74.7	0.968	-24.0
600	0.897	-40.0	3.50	129.0	0.008	84.8	0.963	-26.1
650	0.881	-44.2	3.49	124.2	0.010	72.6	0.957	-28.2
700	0.863	-48.3	3.47	119.4	0.010	67.5	0.950	-30.4
750	0.842	-52.7	3.45	114.5	0.008	78.7	0.943	-32.6
800	0.819	-57.3	3.41	109.7	0.008	82.1	0.939	-34.6
850	0.797	-62.0	3.37	104.9	0.008	85.3	0.931	-36.6
900	0.775	-66.8	3.33	99.9	0.008	95.6	0.924	-38.7
950	0.746	-71.8	3.27	94.9	0.007	97.4	0.916	-40.6
1000	0.721	-76.9	3.20	90.2	0.007	122.8	0.909	-42.4

Package Dimensions

As of January, 2003  
Unit: mm

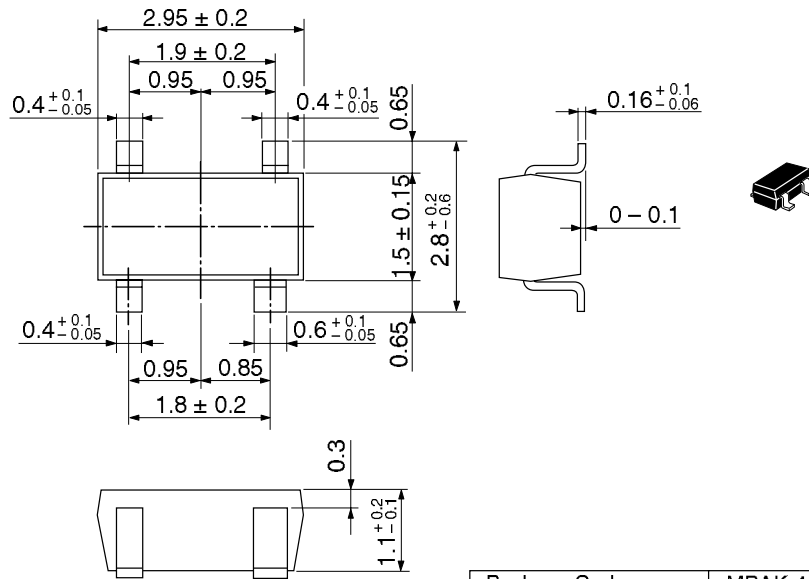

Package Code	MPAK-4
JEDEC	—
JEITA	Conforms
Mass (reference value)	0.013 g

Ordering Information

Part Name	Quantity	Shipping Container
BB505MES-	3000	Taping

Note: For some grades, production may be terminated. Please contact the Renesas sales office to check the state of production before ordering the product.



**Renesas Technology Corp.** Sales Strategic Planning Div. Nippon Bldg., 2-6-2, Ohte-machi, Chiyoda-ku, Tokyo 100-0004, Japan

---

Keep safety first in your circuit designs!

1. Renesas Technology Corp. puts the maximum effort into making semiconductor products better and more reliable, but there is always the possibility that trouble may occur with them. Trouble with semiconductors may lead to personal injury, fire or property damage.  
Remember to give due consideration to safety when making your circuit designs, with appropriate measures such as (i) placement of substitutive, auxiliary circuits, (ii) use of nonflammable material or (iii) prevention against any malfunction or mishap.

Notes regarding these materials

1. These materials are intended as a reference to assist our customers in the selection of the Renesas Technology Corp. product best suited to the customer's application; they do not convey any license under any intellectual property rights, or any other rights, belonging to Renesas Technology Corp. or a third party.
2. Renesas Technology Corp. assumes no responsibility for any damage, or infringement of any third-party's rights, originating in the use of any product data, diagrams, charts, programs, algorithms, or circuit application examples contained in these materials.
3. All information contained in these materials, including product data, diagrams, charts, programs and algorithms represents information on products at the time of publication of these materials, and are subject to change by Renesas Technology Corp. without notice due to product improvements or other reasons. It is therefore recommended that customers contact Renesas Technology Corp. or an authorized Renesas Technology Corp. product distributor for the latest product information before purchasing a product listed herein.

The information described here may contain technical inaccuracies or typographical errors.

Renesas Technology Corp. assumes no responsibility for any damage, liability, or other loss arising from these inaccuracies or errors.

Please also pay attention to information published by Renesas Technology Corp. by various means, including the Renesas Technology Corp. Semiconductor home page (<http://www.renesas.com>).

4. When using any or all of the information contained in these materials, including product data, diagrams, charts, programs, and algorithms, please be sure to evaluate all information as a total system before making a final decision on the applicability of the information and products. Renesas Technology Corp. assumes no responsibility for any damage, liability or other loss resulting from the information contained herein.
  5. Renesas Technology Corp. semiconductors are not designed or manufactured for use in a device or system that is used under circumstances in which human life is potentially at stake. Please contact Renesas Technology Corp. or an authorized Renesas Technology Corp. product distributor when considering the use of a product contained herein for any specific purposes, such as apparatus or systems for transportation, vehicular, medical, aerospace, nuclear, or undersea repeater use.
  6. The prior written approval of Renesas Technology Corp. is necessary to reprint or reproduce in whole or in part these materials.
  7. If these products or technologies are subject to the Japanese export control restrictions, they must be exported under a license from the Japanese government and cannot be imported into a country other than the approved destination.  
Any diversion or reexport contrary to the export control laws and regulations of Japan and/or the country of destination is prohibited.
  8. Please contact Renesas Technology Corp. for further details on these materials or the products contained therein.
- 



**RENESAS SALES OFFICES**

<http://www.renesas.com>

---

**Renesas Technology America, Inc.**

450 Holger Way, San Jose, CA 95134-1368, U.S.A  
Tel: <1> (408) 382-7500 Fax: <1> (408) 382-7501

**Renesas Technology Europe Limited.**

Dukes Meadow, Millboard Road, Bourne End, Buckinghamshire, SL8 5FH, United Kingdom  
Tel: <44> (1628) 585 100, Fax: <44> (1628) 585 900

**Renesas Technology Europe GmbH**

Dornacher Str. 3, D-85622 Feldkirchen, Germany  
Tel: <49> (89) 380 70 0, Fax: <49> (89) 929 30 11

**Renesas Technology Hong Kong Ltd.**

7/F., North Tower, World Finance Centre, Harbour City, Canton Road, Hong Kong  
Tel: <852> 2265-6688, Fax: <852> 2375-6836

**Renesas Technology Taiwan Co., Ltd.**

FL 10, #99, Fu-Hsing N. Rd., Taipei, Taiwan  
Tel: <886> (2) 2715-2888, Fax: <886> (2) 2713-2999

**Renesas Technology (Shanghai) Co., Ltd.**

26/F., Ruijin Building, No.205 Maoming Road (S), Shanghai 200020, China  
Tel: <86> (21) 6472-1001, Fax: <86> (21) 6415-2952

**Renesas Technology Singapore Pte. Ltd.**

1, Harbour Front Avenue, #06-10, Keppel Bay Tower, Singapore 098632  
Tel: <65> 6213-0200, Fax: <65> 6278-8001