

PRELIMINARY
 Notice: This is not a final specification.
 Some parametric limits are subject to change.

MITSUBISHI HVIGBT MODULES CM1200HA-50H

HIGH POWER SWITCHING USE
 INSULATED TYPE

HVIGBT (High Voltage Insulated Gate Bipolar Transistor) Modules

CM1200HA-50H



- IC 1200A
- VCES 2500V
- Insulated Type
- 1-element in a pack

APPLICATION

Inverters, Converters, DC choppers, Induction heating, DC to DC converters.

OUTLINE DRAWING & CIRCUIT DIAGRAM

Dimensions in mm

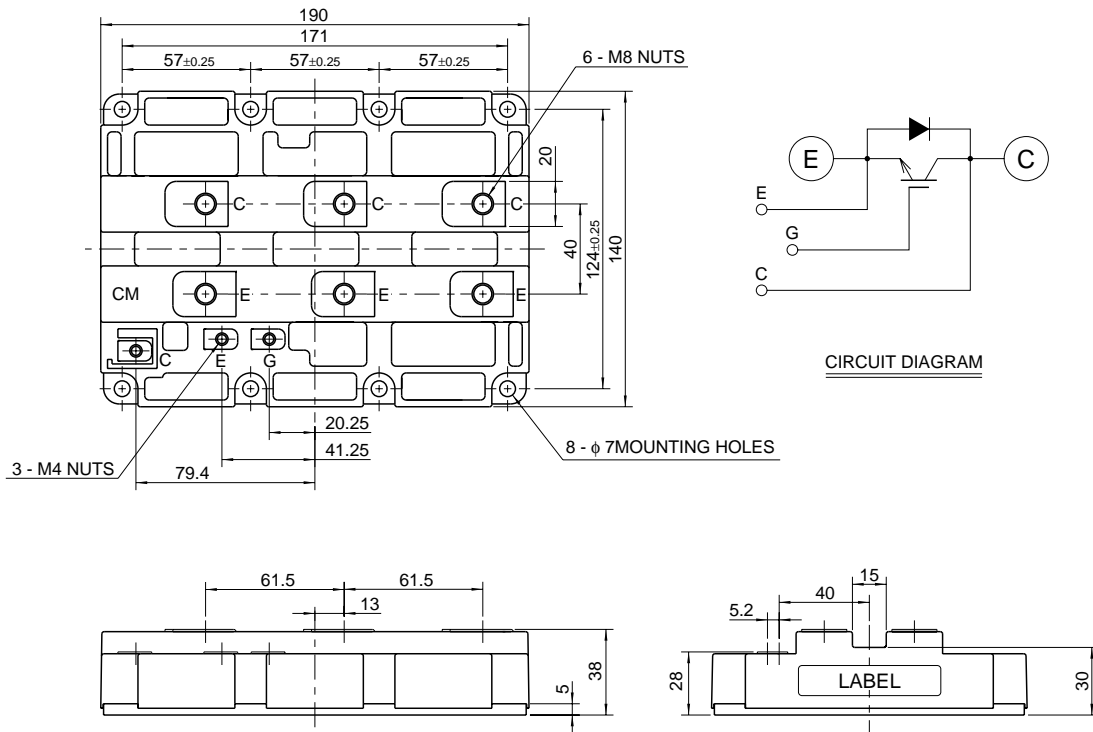

HVIGBT MODULES (High Voltage Insulated Gate Bipolar Transistor Modules)

Mar. 2001

PRELIMINARY
 Notice: This is not a final specification.
 Some parametric limits are subject to change.

CM1200HA-50H

**HIGH POWER SWITCHING USE
 INSULATED TYPE**

HVIGBT (High Voltage Insulated Gate Bipolar Transistor) Modules

MAXIMUM RATINGS (Tj = 25°C)

Symbol	Item	Conditions	Ratings	Unit
V _{CE} S	Collector-emitter voltage	V _{GE} = 0V	2500	V
V _{GE} S	Gate-emitter voltage	V _{CE} = 0V	±20	V
I _C	Collector current	T _C = 25°C	1200	A
I _{CM}		Pulse (Note 1)	2400	A
I _E (Note 2)	Emitter current	T _C = 25°C	1200	A
I _{EM} (Note 2)		Pulse (Note 1)	2400	A
P _C (Note 3)	Maximum collector dissipation	T _C = 25°C, IGBT part	10400	W
T _j	Junction temperature	—	-40 ~ +150	°C
T _{stg}	Storage temperature	—	-40 ~ +125	°C
V _{iso}	Isolation voltage	Charged part to base plate, rms, sinusoidal, AC 60Hz 1min.	6000	V
—	Mounting torque	Main terminals screw M8	6.67 ~ 13.00	N·m
		Mounting screw M6	2.84 ~ 6.00	N·m
		Auxiliary terminals screw M4	0.88 ~ 2.00	N·m
—	Mass	Typical value	2.2	kg

ELECTRICAL CHARACTERISTICS (Tj = 25°C)

Symbol	Item	Conditions	Limits			Unit
			Min	Typ	Max	
I _{CE} S	Collector cutoff current	V _{CE} = V _{CE} S, V _{GE} = 0V	—	—	15	mA
V _{GE(th)}	Gate-emitter threshold voltage	I _C = 120mA, V _{CE} = 10V	4.5	6.0	7.5	V
I _{GE} S	Gate-leakage current	V _{GE} = V _{GE} S, V _{CE} = 0V	—	—	0.5	µA
V _{CE(sat)}	Collector-emitter saturation voltage	T _j = 25°C	—	3.20	4.16	V
		T _j = 125°C	—	3.60	—	
C _{ies}	Input capacitance	V _{CE} = 10V V _{GE} = 0V	—	120	—	nF
C _{oes}	Output capacitance		—	13.2	—	nF
C _{res}	Reverse transfer capacitance		—	4.0	—	nF
Q _G	Total gate charge	V _{CC} = 1250V, I _C = 1200A, V _{GE} = 15V	—	5.4	—	µC
t _{d(on)}	Turn-on delay time	V _{CC} = 1250V, I _C = 1200A	—	—	1.60	µs
t _r	Turn-on rise time	V _{GE1} = V _{GE2} = 15V	—	—	2.00	µs
t _{d(off)}	Turn-off delay time	R _G = 2.5Ω	—	—	2.50	µs
t _f	Turn-off fall time	Resistive load switching operation	—	—	1.00	µs
V _{EC} (Note 2)	Emitter-collector voltage	I _E = 1200A, V _{GE} = 0V	—	2.90	3.77	V
t _{rr} (Note 2)	Reverse recovery time	I _E = 1200A	—	—	1.20	µs
Q _{rr} (Note 2)	Reverse recovery charge	die / dt = -2400A / µs	—	250	—	µC
R _{th(j-c)Q}	Thermal resistance	Junction to case, IGBT part	—	—	0.012	K/W
R _{th(j-c)R}		Junction to case, FWDI part	—	—	0.024	K/W
R _{th(c-f)}	Contact thermal resistance	Case to fin, conductive grease applied	—	0.006	—	K/W

- Note 1. Pulse width and repetition rate should be such that the device junction temp. (T_j) does not exceed T_{jmax} rating.
 2. I_E, V_{EC}, t_{rr}, Q_{rr} & die/dt represent characteristics of the anti-parallel, emitter to collector free-wheel diode.
 3. Junction temperature (T_j) should not increase beyond 150°C.
 4. Pulse width and repetition rate should be such as to cause negligible temperature rise.

PRELIMINARY
 Notice: This is not a final specification.
 Some parametric limits are subject to change.

CM1200HA-50H

**HIGH POWER SWITCHING USE
 INSULATED TYPE**

HVIGBT (High Voltage Insulated Gate Bipolar Transistor) Modules

PERFORMANCE CURVES

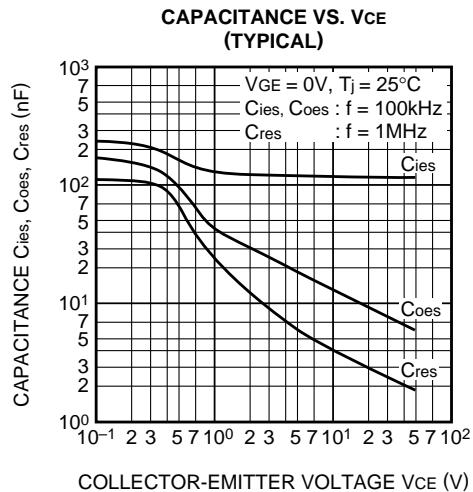
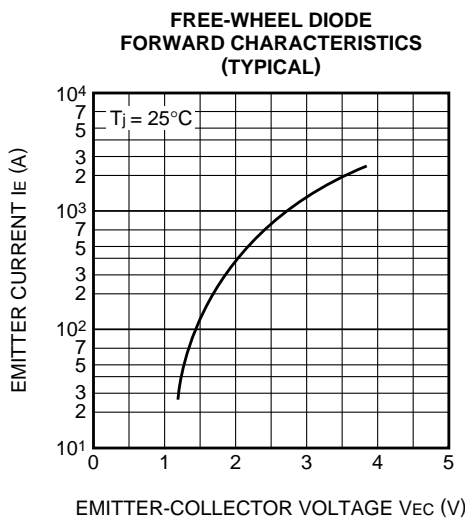
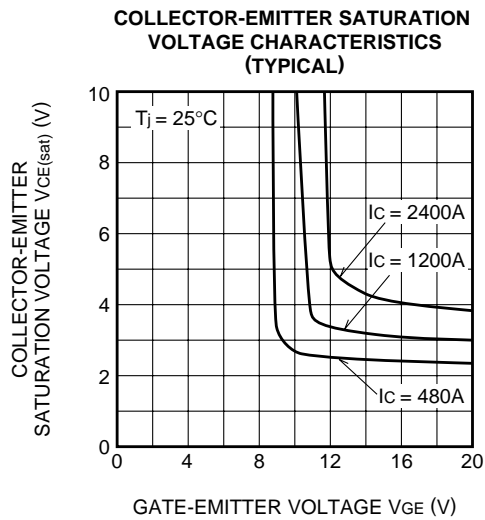
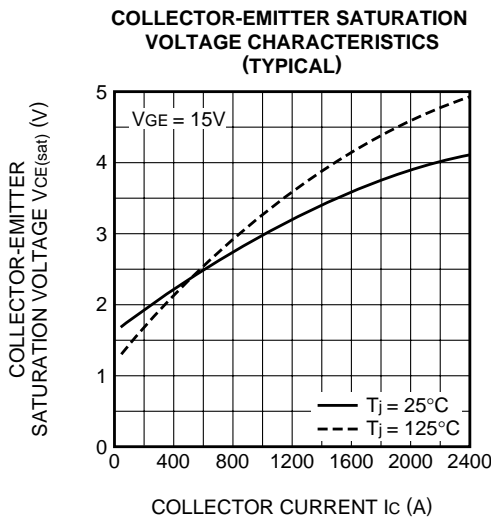
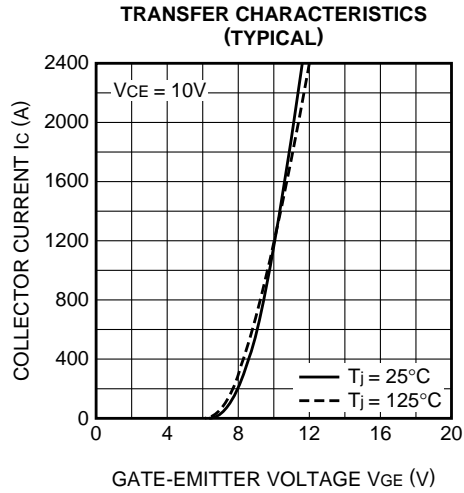
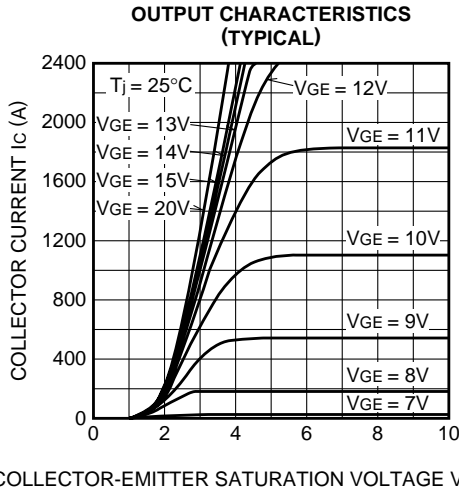

PRELIMINARY
 Notice: This is not a final specification.
 Some parametric limits are subject to change.

CM1200HA-50H

**HIGH POWER SWITCHING USE
 INSULATED TYPE**

HVIGBT (High Voltage Insulated Gate Bipolar Transistor) Modules

**HALF-BRIDGE
 SWITCHING CHARACTERISTICS
 (TYPICAL)**

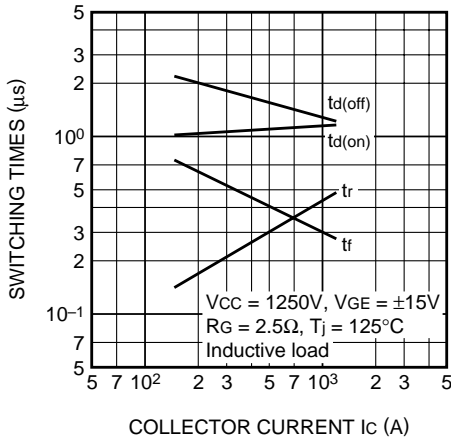

**REVERSE RECOVERY CHARACTERISTICS
 OF FREE-WHEEL DIODE
 (TYPICAL)**

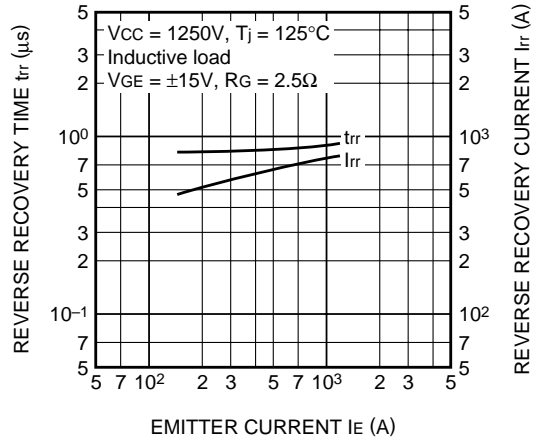

**TRANSIENT THERMAL
 IMPEDANCE CHARACTERISTICS
 (IGBT part)**

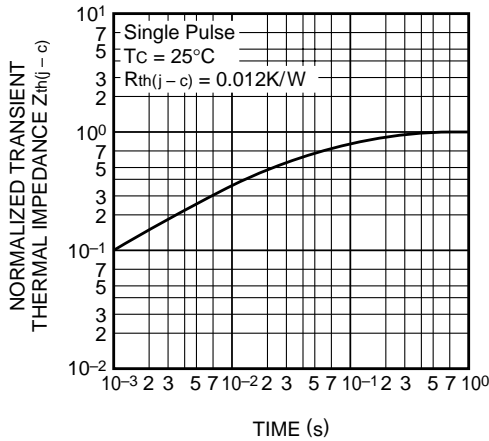

**TRANSIENT THERMAL
 IMPEDANCE CHARACTERISTICS
 (FWDi part)**

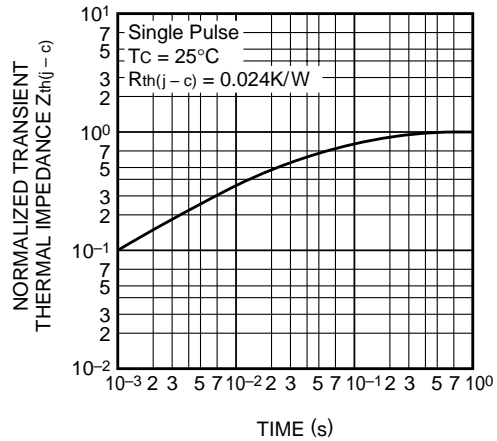

**V_{GE} - GATE CHARGE
 (TYPICAL)**

