



- Contents -

| | |
|--|-----|
| ▣ General handling precautions | 1~2 |
| ▣ Electrical & optical parameters & definitions | 3 |
| ▣ Package type & dimensions | 4~5 |
| ▣ How to read the part number - Numbering | 5 |
| | |
| ▣ Red laser - 635nm | |
| 1. SLD63518240 for Measuring instrument | 6 |
| 2. SLD63518240C for Measuring instrument | 7 |
| 3. SLD63518240J for Measuring instrument | 8 |
| 4. SLD63518250 for Measuring instrument / Barcode Scanner | 9 |
| 5. SLD63518260 for Measuring instrument / Barcode Scanner | 10 |
| 6. SLD63518350 for Measuring instrument / Barcode Scanner | 11 |
| | |
| ▣ Red laser - 650nm | |
| 7. SLD65018250ST for Barcode Scanner / Pointer | 12 |
| 8. SLD65038250ST for Barcode Scanner / Pointer | 13 |
| 9. SLD65018260 for Barcode Scanner / Sensor | 14 |
| 10. SLD65018271 for DVD-P / DVD-R | 15 |
| 11. SLD65018271L for DVD-P / DVD-R | 16 |
| 12. SLD65018271M for DVD-P / DVD-R | 17 |
| 13. SLD65018371 for DVD-Combo / Industrial Barcode Scanner | 18 |
| 14. SLD65018871 for DVD-RW | 19 |
| | |
| ▣ Infrared laser - 780nm | |
| 15. SLD78018261 for CD-P / CD-R | 20 |
| 16. SLD78018261F for CD-P / CD-R | 21 |
| 17. SLD78018262C for LSU (Laser printer) | 22 |
| 18. SLD78018271D for CD-P (Discman) | 23 |
| 19. SLD78018360P for LSU (Laser printer) | 24 |
| 20. SLD78018371 for CD-R / CD-P | 25 |
| 21. SLD78018971 for CD-RW | 26 |
| | |
| ▣ Red / Infra-Red Monolithic laser | |
| 22. 2 Beam laser for DVD-P / DVD-R | 27 |
| | |
| ▣ Packing spec. | 28 |
| | |
| ▣ Labeling spec. | 28 |



Samsung Semiconductor Laser

General handling precautions

1. INTRODUCTION

Laser Diode (LD) is a semiconductor device with p-n junction which emit laser / strong coherency / radiation by applying a current in forward direction. However, in difference from usually semiconductor diodes LD have the next peculiarities:

1.LD usually operates at operation current 20~40mA for a low power LD and 80~120mA for a high power LD and low applied forward voltage (usually ~2V). But very important peculiarity of LD is high current densities (~2000~4000A/cm²) during LD operation. Therefore, LD operation generates a significant heat thin active layer.

2.In normal operation mode LD has a relatively small volume for laser output power (3~7mW for low power LD and 25~220mW for high power LD). But they have a very high density of laser radiation in a active layer and on output mirror facet (~1.0MW/cm² and more). Therefore, there is a optical power limit caused by optical damage of output mirror facet / COD (Catastrophic Optical Damage) /.

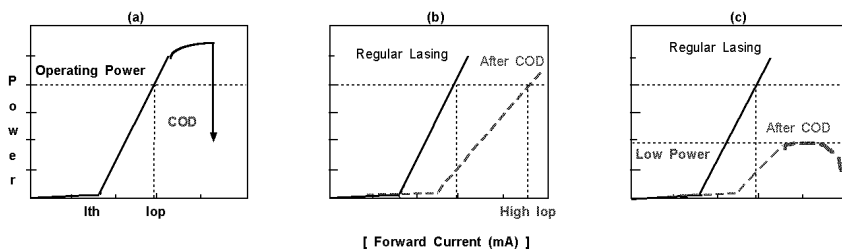

Fig. 1 COD (Catastrophic Optical Damage)

Fig.1 shows us typical COD phenomenon of laser diode. When you operate LD after occurrence of COD, operating current at a specific power would be much higher than before COD -Fig.1(b)-. In the worst case, laser power could not reach a required power due to COD -Fig.1(c)-. When you drive LD, please pay attention to LD operation under COD power level.

3.LD has a very quick electrical and light response (lower than a few nano-second and less). In connection with these features LD are extremely susceptible to damage caused by current surges. It must be stressed here that even an instantaneous application extra pulse current cause a rapid LD's deterioration. Whenever You handle LD, please pay strict attention to the following precautions.

2. ELECTROSTATIC SURGE PREVENTION.

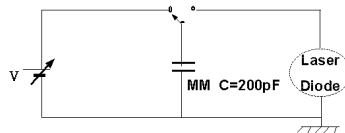

Fig. 2 Static Electricity Test Circuit

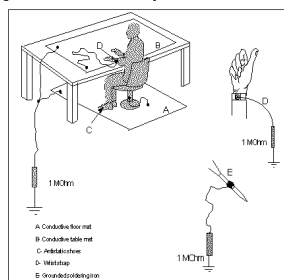

Fig. 3

It is necessary to strike that LD are even more sensitive to electrostatic discharge than Si-based semiconductor chips and require more careful preventive measures. COD also could be happened by small surge due to electrostatic discharge. Fig. 2 shows us a static electricity test circuit of Samsung. When shipping the laser diodes, they would be inserted in antistatic bags to prevent electrostatic charging by transportation. Example of a typical workbench for operation with Laser Diode Fig. 3 :

- 1.Ground work tables and floors using conductive table mats and floor mats;
- 2.Ground operators using conductive wrist bands;
- 3.All used tools as well as soldering irons should be ground

The grounding should be connected through a resistor of approximately 1MΩ



Samsung Semiconductor Laser

3. PRECAUTIONS FOR CURRENT DRIVING CIRCUITS

1. While operating, LD can be easily damaged by surge currents which may occur during power on and off of the drive circuit or while adjusting the optical power output.

2. If possible, for standard testing process we recommend to use the special industrial laser diode current driver for example the Melles Griot current source 06 DLD 201 or other type.

3. When you use nonindustrial self designed drivers, please make it sure that the spike current generated in on-off switching of power supplies does not exceed the maximum LD operation current. It is recommended to insert an appropriate filter consisting of a appropriate CR circuit or other slow start circuit when chattering or overshoot shown in Fig. 4. Care must also be taken to prevent surge currents from entering the circuit from external sources. Use an AC noise filter.

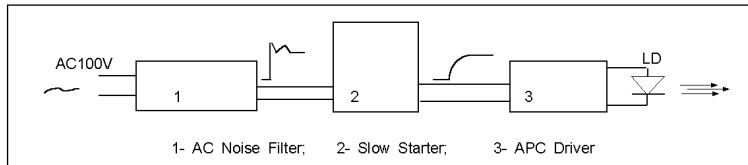

Fig. 4

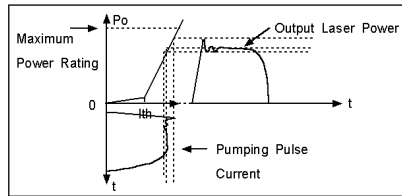

Fig. 5

In pulse mode operation, overshoot in optical power output is sometimes observed.

In this case, try to suppress the overshoot or lower the overshoot power level below the maximum LD operation current shown in Fig. 5.

4. Make all electrical connections secure. An open or short circuit while the LD is on, will result in deterioration. It is desirable to use shielded cables.

5. Use a reliable control for setting the operation current. Improper contacts may result in current surges.

6. While LD is powered up, don't touch probes from a oscilloscope or volt-meter against the circuit or LD terminals.

7. Don't **CONNECT OR DISCONNECT** the laser diode terminals while the **POWER** is **ON**.

4. HEAT DIFFUSION PRECAUTIONS.

1. All main LD's parameters depend on a temperature. Because of LD in operation during generation of heat at the p-n junction/ active layer/ it is necessary provide a good heat conduction mechanism. Usually LD chip is mounted on a heat sink within the package to facilitate effective heat diffusion. Because the heat sink conducts the generated heat to the package flange, it is advisable LD to attach a heat radiator to the LD package flange for better heat diffusion. Thermal contact between the package flange and the heat radiator plate must be good. Furthermore heat diffusion also depends on the design of the radiator plate, i.e., shape, size and material. An appropriate design is required for each industrial application.

2. Ineffective heat diffusion can cause a positive feed back of driving current and limit the usability of the LD. Namely, high temperature of LD package reduces an optical output power below an expected level, which requires higher driving current to maintain the nominal output. As a result, this raises the temperature and requires more higher current. Thus excessive driving current can destroy LD.

5. ON THE SAFETY OF LASER LIGHT

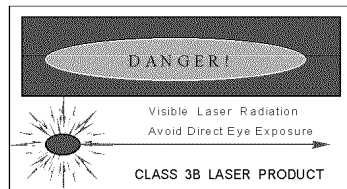

Avoid to look into the laser light directly or directly through an optical system. It is very **DANGEROUS!** Samsung red and IR laser diodes correspond to the class IIIb of the International Radiation Standard of the Laser Products.

Although the typical optical output power of Samsung low power laser ranges from a several mW to 5mW, their power density can reach 1MW/cm². For observing laser beam safely, you always have to use safety goggles that block infrared rays.



Samsung Semiconductor Laser

■ Electrical & optical parameters & definitions

| | | |
|--|-----------------------|---|
| Output optical power | Pop | Maximum allowable instantaneous light power in pulse or CW mode. Up to this output level there are no kinks in the Light-Current curve. |
| Operating current | Iop | The forward current through the LD which necessary for the LD to produce its specified typical optical output power |
| Operating voltage | Vop | The forward voltage across the LD by forward operating current |
| Wavelength | λ_p | The wavelength of the laser spectral line with the greatest intensity |
| Watt-ampere / Slope / Efficiency | SE | The value of the incremental change in laser beam power for an incremental change in forward current above the threshold current. |
| Monitoring current | I_m | The monitoring photodiode current is proportional to LD laser output power/ at a specified reverse bias voltage |
| Threshold current | I_{th} | The forward current value at which the LD begins to produce laser output |
| Laser beam divergency in horizontal plane | $\theta_{//}$ | The laser beam's full angular at the half-maximum intensity points(FWHM), measured in horizontal plane /parallel to the LD p-n junction plane/ |
| Laser beam divergency in vertical plane | θ_{\perp} | The laser beam's full angular at the half-maximum intensity points(FWHN), measured in vertical plane /perpendicular to the LD p-n junction plane/ |
| LD reverse voltage | VR | Maximum admissible reverse bias voltage, which may be applied to the LD without a damage |
| PD bias voltage | VR_p | Maximum admissible reverse bias voltage, which may be applied to the monitoring PD without a damage |
| Operating temperature | Topr | Range of the case temperature within which LD may be safety stored |
| Storage temperature | Tstg | Range of the ambient temperature within which LD may be safety stored |
| Forward current | If | Current through the forward biased LD |
| Forward bias voltage | Vf | Laser diode voltage by an applied forward bias |



Samsung Semiconductor Laser

Package 1 : TO-18 (Φ5.6mm)

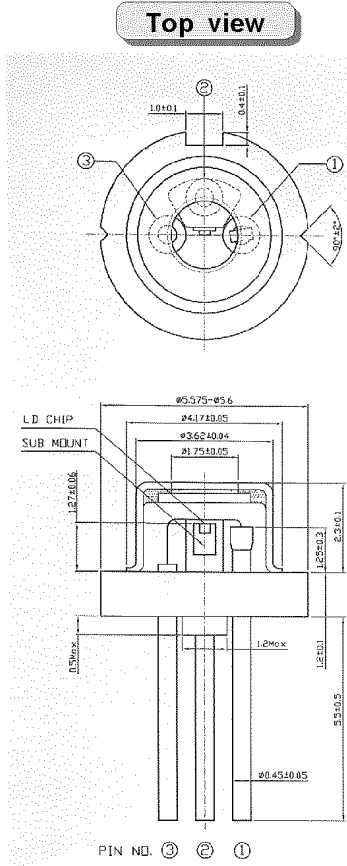

Front view

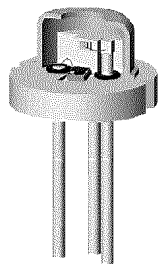

Package 2 : Φ3.8mm Small size

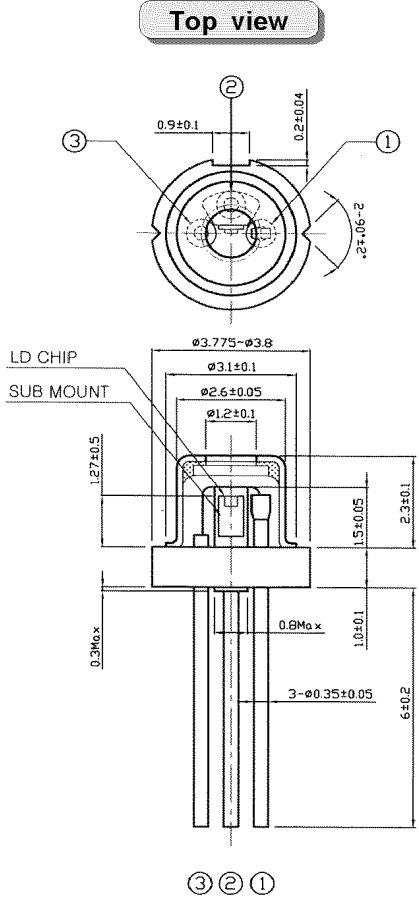

Front view

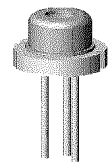



Samsung Semiconductor Laser

Package 3 : Mold type package

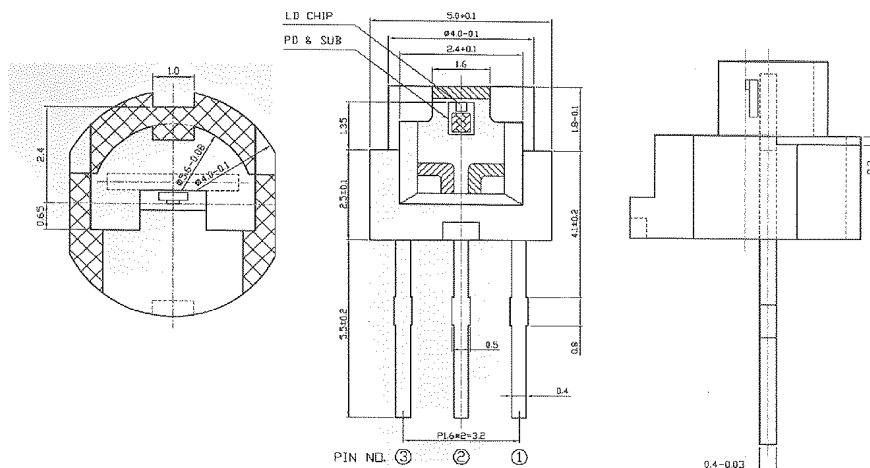

How to read the part number - Numbering

Ex.) **SLD - 650 - 18 - 2 7 1 X**

① ② ③ ④ ⑤ ⑥ ⑦

- ① **Samsung Laser Diode**
- ② **Wavelength** : 635nm, 650nm, 780nm
- ③ **Package type** : 18 ⇒ TO-18 (5.6mm)
38 ⇒ Small package (3.8mm)
★ Suffix 'F' ⇒ Mold type package
- ④ **Optical power** : 2 ⇒ 5mW, 3 ⇒ 7mW, 8 ⇒ 50mW, 9 ⇒ 90mW
- ⑤ **Operating Temp** : 4 ⇒ 40°C, 5 ⇒ 50°C, 6 ⇒ 60°C, 7 ⇒ 70°C
- ⑥ **Pin configuration** : 0 ⇒ LD anode, PD cathode, common
1 ⇒ LD anode, PD anode, common
2 ⇒ LD cathode, PD anode, common
- ⑦ **Suffix** : Derivative parts



1. SLD63518240

■ Application : Measuring Instrument

■ Features

- Lasing wavelength : $\lambda_p = 635\text{nm}$
- Optical output power : $P_o = 5\text{mW (CW)}$
- Package type : TO-18 [$\Phi 5.6$]
- Built-in photodiode for optical power monitoring
- InGaAlP laser with multi-quantum well structure

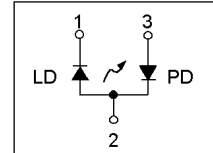

[SLD63518240]

■ Absolute maximum ratings [$T_c = 25^\circ\text{C}$]

| Parameter | Symbol | Value | Unit |
|-----------------------|-----------|-----------|------------------|
| Optical output power | P_o | 7 | mW |
| LD reverse voltage | VR | 2 | V |
| PD reverse voltage | VR | 30 | V |
| Operating temperature | T_{opr} | -10 ~ +40 | $^\circ\text{C}$ |
| Storage temperature | T_{stg} | -40 ~ +85 | $^\circ\text{C}$ |

■ Electrical & optical characteristics [$T_c = 25^\circ\text{C}$]

| Parameter | Symbol | Condition | Min. | Typ. | Max. | Unit |
|-------------------------|--------------------------------|--------------------|------|------|-----------|---------------|
| Optical output power | P_o | - | - | 5 | - | mW |
| Threshold current | I_{th} | - | - | 30 | 35 | mA |
| Operating current | I_{op} | $P_o = 5\text{mW}$ | - | 38 | 40 | mA |
| Operating voltage | V_{op} | $P_o = 5\text{mW}$ | - | 2.2 | 2.7 | V |
| Monitor current | I_m | $P_o = 5\text{mW}$ | 0.01 | 0.04 | 0.1 | mA |
| Lasing wavelength | λ | $P_o = 5\text{mW}$ | 630 | 637 | 640 | nm |
| Beam divergence | $\theta_{//}$ | $P_o = 5\text{mW}$ | 6 | 8 | 15 | degree |
| | θ_{\perp} | $P_o = 5\text{mW}$ | 22 | 33 | 40 | |
| Beam angle accuracy | $\Delta\theta_{//}$ | $P_o = 5\text{mW}$ | - | - | ± 1.5 | degree |
| | $\Delta\theta_{\perp}$ | $P_o = 5\text{mW}$ | - | - | ± 2.5 | |
| Positional accuracy | $\Delta X, \Delta Y, \Delta Z$ | $P_o = 5\text{mW}$ | - | - | ± 60 | μm |
| Differential efficiency | η | - | 0.3 | 0.5 | 0.7 | mW/mA |
| Astigmatism | A_s | $P_o = 5\text{mW}$ | - | - | - | μm |



2. SLD63518240C

■ Application : Measuring Instrument

■ Features

- Lasing wavelength : $\lambda_p = 635\text{nm}$
- Optical output power : $P_o = 5\text{mW (CW)}$
- Package type : TO-18 [$\Phi 5.6$]
- Built-in photodiode for optical power monitoring
- InGaAlP laser with multi-quantum well structure

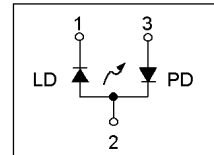

[SLD63518240C]

■ Absolute maximum ratings [$T_c = 25^\circ\text{C}$]

| Parameter | Symbol | Value | Unit |
|-----------------------|--------|-----------|------------------|
| Optical output power | P_o | 7 | mW |
| LD reverse voltage | VR | 2 | V |
| PD reverse voltage | VR | 30 | V |
| Operating temperature | Topr | -10 ~ +40 | $^\circ\text{C}$ |
| Storage temperature | Tstg | -40 ~ +85 | $^\circ\text{C}$ |

■ Electrical & optical characteristics [$T_c = 25^\circ\text{C}$]

| Parameter | Symbol | Condition | Min. | Typ. | Max. | Unit |
|-------------------------|--------------------------------|--------------------|------|------|-----------|---------------|
| Optical output power | P_o | - | - | 5 | - | mW |
| Threshold current | I_{th} | - | - | 30 | 35 | mA |
| Operating current | I_{op} | $P_o = 5\text{mW}$ | - | 33 | 36 | mA |
| Operating voltage | V_{op} | $P_o = 5\text{mW}$ | - | 2.2 | 2.7 | V |
| Monitor current | I_m | $P_o = 5\text{mW}$ | 0.01 | 0.04 | 0.1 | mA |
| Lasing wavelength | λ | $P_o = 5\text{mW}$ | 630 | 637 | 640 | nm |
| Beam divergence | $\theta_{//}$ | $P_o = 5\text{mW}$ | 6 | 8 | 15 | degree |
| | θ_{\perp} | $P_o = 5\text{mW}$ | 22 | 32 | 40 | |
| Beam angle accuracy | $\Delta\theta_{//}$ | $P_o = 5\text{mW}$ | - | - | ± 1.5 | |
| | $\Delta\theta_{\perp}$ | $P_o = 5\text{mW}$ | - | - | ± 2.5 | |
| Positional accuracy | $\Delta X, \Delta Y, \Delta Z$ | $P_o = 5\text{mW}$ | - | - | ± 60 | μm |
| Differential efficiency | η | - | 0.3 | 0.5 | 0.7 | mW/mA |
| Astigmatism | A_s | $P_o = 5\text{mW}$ | - | - | - | μm |



3. SLD63518240J

■ Application : Measuring Instrument

■ Features

- Lasing wavelength : $\lambda_p = 635\text{nm}$
- Optical output power : $P_o = 5\text{mW (CW)}$
- Package type : TO-18 [$\Phi 5.6$]
- Built-in photodiode for optical power monitoring
- InGaAlP laser with multi-quantum well structure

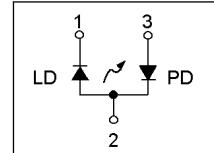

[SLD63518240J]

■ Absolute maximum ratings [$T_c = 25^\circ\text{C}$]

| Parameter | Symbol | Value | Unit |
|-----------------------|-----------|-----------|------------------|
| Optical output power | P_o | 7 | mW |
| LD reverse voltage | VR | 2 | V |
| PD reverse voltage | VR | 30 | V |
| Operating temperature | T_{opr} | -10 ~ +40 | $^\circ\text{C}$ |
| Storage temperature | T_{stg} | -40 ~ +85 | $^\circ\text{C}$ |

■ Electrical & optical characteristics [$T_c = 25^\circ\text{C}$]

| Parameter | Symbol | Condition | Min. | Typ. | Max. | Unit |
|-------------------------|--------------------------------|--------------------|------|------|-----------|---------------|
| Optical output power | P_o | - | - | 5 | - | mW |
| Threshold current | I_{th} | - | - | 30 | 35 | mA |
| Operating current | I_{op} | $P_o = 5\text{mW}$ | - | 43 | 48 | mA |
| Operating voltage | V_{op} | $P_o = 5\text{mW}$ | - | 2.3 | 2.7 | V |
| Monitor current | I_m | $P_o = 5\text{mW}$ | 0.01 | 0.04 | 0.1 | mA |
| Lasing wavelength | λ | $P_o = 5\text{mW}$ | 630 | 637 | 640 | nm |
| Beam divergence | $\theta_{//}$ | $P_o = 5\text{mW}$ | 6 | 8 | 15 | degree |
| | θ_{\perp} | $P_o = 5\text{mW}$ | 22 | 32 | 40 | |
| Beam angle accuracy | $\Delta\theta_{//}$ | $P_o = 5\text{mW}$ | - | - | ± 1.5 | |
| | $\Delta\theta_{\perp}$ | $P_o = 5\text{mW}$ | - | - | ± 2.5 | |
| Positional accuracy | $\Delta X, \Delta Y, \Delta Z$ | $P_o = 5\text{mW}$ | - | - | ± 60 | μm |
| Differential efficiency | η | - | 0.3 | 0.5 | 0.7 | mW/mA |
| Astigmatism | As | $P_o = 5\text{mW}$ | - | - | - | μm |



4. SLD63518250

■ Application : Measuring Instrument, Barcode Scanner

■ Features

- Lasing wavelength : $\lambda_p = 635\text{nm}$
- Optical output power : $P_o = 5\text{mW (CW)}$
- Package type : TO-18 [$\Phi 5.6$]
- Built-in photodiode for optical power monitoring
- InGaAlP laser with multi-quantum well structure

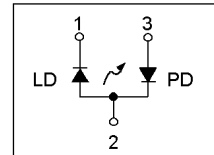

[SLD63518250]

■ Absolute maximum ratings [$T_c = 25^\circ\text{C}$]

| Parameter | Symbol | Value | Unit |
|-----------------------|--------|-----------|------------------|
| Optical output power | P_o | 7 | mW |
| LD reverse voltage | VR | 2 | V |
| PD reverse voltage | VR | 30 | V |
| Operating temperature | Topr | -10 ~ +50 | $^\circ\text{C}$ |
| Storage temperature | Tstg | -40 ~ +85 | $^\circ\text{C}$ |

■ Electrical & optical characteristics [$T_c = 25^\circ\text{C}$]

| Parameter | Symbol | Condition | Min. | Typ. | Max. | Unit |
|-------------------------|--------------------------------|--------------------|------|------|-----------|---------------|
| Optical output power | P_o | - | - | 5 | - | mW |
| Threshold current | I_{th} | - | - | 30 | 40 | mA |
| Operating current | I_{op} | $P_o = 5\text{mW}$ | - | 40 | 52 | mA |
| Operating voltage | V_{op} | $P_o = 5\text{mW}$ | - | 2.2 | 2.7 | V |
| Monitor current | I_m | $P_o = 5\text{mW}$ | 0.1 | 0.3 | 0.5 | mA |
| Lasing wavelength | λ | $P_o = 5\text{mW}$ | 630 | 637 | 640 | nm |
| Beam divergence | $\theta_{//}$ | $P_o = 5\text{mW}$ | 6 | 8 | 10 | degree |
| | θ_{\perp} | $P_o = 5\text{mW}$ | 30 | 33 | 40 | |
| Beam angle accuracy | $\Delta\theta_{//}$ | $P_o = 5\text{mW}$ | - | - | ± 2.0 | |
| | $\Delta\theta_{\perp}$ | $P_o = 5\text{mW}$ | - | - | ± 2.5 | |
| Positional accuracy | $\Delta X, \Delta Y, \Delta Z$ | $P_o = 5\text{mW}$ | - | - | ± 60 | μm |
| Differential efficiency | η | - | 0.4 | 0.6 | 0.8 | mW/mA |
| Astigmatism | As | $P_o = 5\text{mW}$ | - | - | - | μm |



5. SLD63518260 - Preliminary

■ Application : Measuring Instrument, Barcode Scanner

■ Features

- Lasing wavelength : $\lambda_p = 635\text{nm}$
- Optical output power : $P_o = 5\text{mW}$ (CW)
- Package type : TO-18 [Φ 5.6]
- Built-in photodiode for optical power monitoring
- InGaAlP laser with multi-quantum well structure

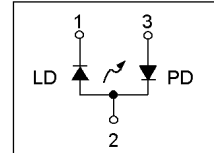

[SLD63518260]

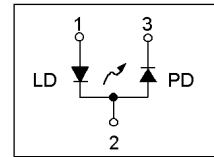

[SLD63518262]

■ Absolute maximum ratings [$T_c = 25^\circ\text{C}$]

| Parameter | Symbol | Value | Unit |
|-----------------------|-----------|-----------|------------------|
| Optical output power | P_o | 7 | mW |
| LD reverse voltage | VR | 2 | V |
| PD reverse voltage | VR | 30 | V |
| Operating temperature | T_{opr} | -10 ~ +60 | $^\circ\text{C}$ |
| Storage temperature | T_{stg} | -40 ~ +85 | $^\circ\text{C}$ |

■ Electrical & optical characteristics [$T_c = 25^\circ\text{C}$]

| Parameter | Symbol | Condition | Min. | Typ. | Max. | Unit |
|-------------------------|--------------------------------|--------------------|------|------|-----------|---------------|
| Optical output power | P_o | - | - | 5 | - | mW |
| Threshold current | I_{th} | - | - | 30 | 40 | mA |
| Operating current | I_{op} | $P_o = 5\text{mW}$ | - | 45 | 60 | mA |
| Operating voltage | V_{op} | $P_o = 5\text{mW}$ | - | 2.2 | 2.7 | V |
| Monitor current | I_m | $P_o = 5\text{mW}$ | 0.1 | 0.2 | 0.5 | mA |
| Lasing wavelength | λ | $P_o = 5\text{mW}$ | 630 | 637 | 640 | nm |
| Beam divergence | $\theta_{//}$ | $P_o = 5\text{mW}$ | 7 | 8.5 | 10 | degree |
| | θ_{\perp} | $P_o = 5\text{mW}$ | 22 | 33 | 40 | |
| Beam angle accuracy | $\Delta\theta_{//}$ | $P_o = 5\text{mW}$ | - | - | ± 2.0 | |
| | $\Delta\theta_{\perp}$ | $P_o = 5\text{mW}$ | - | - | ± 2.5 | |
| Positional accuracy | $\Delta X, \Delta Y, \Delta Z$ | $P_o = 5\text{mW}$ | - | - | ± 60 | μm |
| Differential efficiency | η | - | 0.4 | 0.65 | 0.9 | mW/mA |
| Astigmatism | As | $P_o = 5\text{mW}$ | - | - | - | μm |



6. SLD63518350 - Preliminary

■ Application : Measuring Instrument

■ Features

- Lasing wavelength : $\lambda_p = 635\text{nm}$
- Optical output power : $P_o = 7\text{mW (CW)}$
- Package type : TO-18 [$\Phi 5.6$]
- Built-in photodiode for optical power monitoring
- High power laser
- InGaAIP laser with multi-quantum well structure

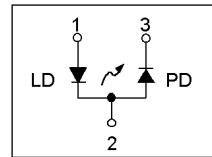
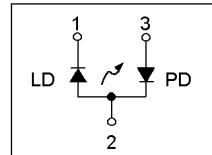

■ Absolute maximum ratings [$T_c = 25^\circ\text{C}$]

| Parameter | Symbol | Value | Unit |
|-----------------------|-----------|-----------|------------------|
| Optical output power | P_o | 10 | mW |
| LD reverse voltage | VR | 2 | V |
| PD reverse voltage | VR | 30 | V |
| Operating temperature | T_{opr} | -10 ~ +50 | $^\circ\text{C}$ |
| Storage temperature | T_{stg} | -40 ~ +85 | $^\circ\text{C}$ |

■ Electrical & optical characteristics [$T_c = 25^\circ\text{C}$]

| Parameter | Symbol | Condition | Min. | Typ. | Max. | Unit |
|-------------------------|--------------------------------|--------------------|------|------|-----------|---------------|
| Optical output power | P_o | - | - | 7 | - | mW |
| Threshold current | I_{th} | - | - | 30 | 40 | mA |
| Operating current | I_{op} | $P_o = 7\text{mW}$ | - | 45 | 60 | mA |
| Operating voltage | V_{op} | $P_o = 7\text{mW}$ | - | 2.2 | 2.7 | V |
| Monitor current | I_m | $P_o = 7\text{mW}$ | 0.1 | 0.2 | 0.5 | mA |
| Lasing wavelength | λ | $P_o = 7\text{mW}$ | 630 | 637 | 640 | nm |
| Beam divergence | $\theta_{//}$ | $P_o = 7\text{mW}$ | 6 | 8.5 | 10 | degree |
| | θ_{\perp} | $P_o = 7\text{mW}$ | 30 | 33 | 40 | |
| Beam angle accuracy | $\Delta\theta_{//}$ | $P_o = 7\text{mW}$ | - | - | ± 2.0 | |
| | $\Delta\theta_{\perp}$ | $P_o = 7\text{mW}$ | - | - | ± 2.5 | |
| Positional accuracy | $\Delta X, \Delta Y, \Delta Z$ | $P_o = 7\text{mW}$ | - | - | ± 60 | μm |
| Differential efficiency | η | - | 0.4 | 0.6 | 0.8 | mW/mA |
| Astigmatism | As | $P_o = 7\text{mW}$ | - | - | - | μm |



7. SLD65018250ST

■ Application : Barcode Scanner, Pointer

■ Features

- Lasing wavelength : $\lambda_p = 650\text{nm}$
- Optical output power : $P_o = 5\text{mW (CW)}$
- Package type : TO-18 [$\Phi 5.6$]
- Built-in photodiode for optical power monitoring
- InGaAlP laser with multi-quantum well structure

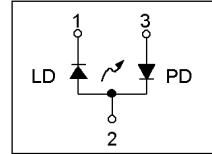

[SLD65018250ST]

■ Absolute maximum ratings [$T_c = 25^\circ\text{C}$]

| Parameter | Symbol | Value | Unit |
|-----------------------|-----------|-----------|------------------|
| Optical output power | P_o | 7 | mW |
| LD reverse voltage | VR | 2 | V |
| PD reverse voltage | VR | 30 | V |
| Operating temperature | T_{opr} | -10 ~ +50 | $^\circ\text{C}$ |
| Storage temperature | T_{stg} | -40 ~ +85 | $^\circ\text{C}$ |

■ Electrical & optical characteristics [$T_c = 25^\circ\text{C}$]

| Parameter | Symbol | Condition | Min. | Typ. | Max. | Unit |
|-------------------------|--------------------------------|--------------------|------|------|-----------|---------------|
| Optical output power | P_o | - | - | 5 | - | mW |
| Threshold current | I_{th} | - | - | 23 | 35 | mA |
| Operating current | I_{op} | $P_o = 5\text{mW}$ | - | 30 | 40 | mA |
| Operating voltage | V_{op} | $P_o = 5\text{mW}$ | - | 2.2 | 2.6 | V |
| Monitor current | I_m | $P_o = 5\text{mW}$ | 0.1 | 0.2 | 0.5 | mA |
| Lasing wavelength | λ | $P_o = 5\text{mW}$ | 650 | 655 | 660 | nm |
| Beam divergence | $\theta_{//}$ | $P_o = 5\text{mW}$ | 6 | 8 | 11 | degree |
| | θ_{\perp} | $P_o = 5\text{mW}$ | 22 | 30 | 38 | |
| Beam angle accuracy | $\Delta\theta_{//}$ | $P_o = 5\text{mW}$ | - | - | ± 2.0 | |
| | $\Delta\theta_{\perp}$ | $P_o = 5\text{mW}$ | - | - | ± 3.0 | |
| Positional accuracy | $\Delta X, \Delta Y, \Delta Z$ | $P_o = 5\text{mW}$ | - | - | ± 60 | μm |
| Differential efficiency | η | - | 0.5 | 0.75 | 0.95 | mW/mA |
| Astigmatism | A_s | $P_o = 5\text{mW}$ | - | - | - | μm |



8. SLD65038250ST

■ Application : Barcode Scanner, Pointer

■ Features

- Lasing wavelength : $\lambda_p = 650\text{nm}$
- Optical output power : $P_o = 5\text{mW (CW)}$
- Package type : Small Package [$\Phi 3.8$]
- Built-in photodiode for optical power monitoring
- Ultra small package
- InGaAIP laser with multi-quantum well structure

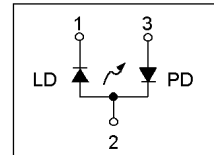

[SLD65038250ST]

■ Absolute maximum ratings [$T_c = 25^\circ\text{C}$]

| Parameter | Symbol | Value | Unit |
|-----------------------|-----------|-----------|------------------|
| Optical output power | P_o | 7 | mW |
| LD reverse voltage | VR | 2 | V |
| PD reverse voltage | VR | 30 | V |
| Operating temperature | T_{opr} | -10 ~ +50 | $^\circ\text{C}$ |
| Storage temperature | T_{stg} | -40 ~ +85 | $^\circ\text{C}$ |

■ Electrical & optical characteristics [$T_c = 25^\circ\text{C}$]

| Parameter | Symbol | Condition | Min. | Typ. | Max. | Unit |
|-------------------------|--------------------------------|--------------------|------|------|-----------|---------------|
| Optical output power | P_o | - | - | 5 | - | mW |
| Threshold current | I_{th} | - | - | 30 | 35 | mA |
| Operating current | I_{op} | $P_o = 5\text{mW}$ | - | 35 | 45 | mA |
| Operating voltage | V_{op} | $P_o = 5\text{mW}$ | - | 2.2 | 2.6 | V |
| Monitor current | I_m | $P_o = 5\text{mW}$ | 0.08 | 0.2 | 0.5 | mA |
| Lasing wavelength | λ | $P_o = 5\text{mW}$ | 650 | 655 | 660 | nm |
| Beam divergence | $\theta_{//}$ | $P_o = 5\text{mW}$ | 6 | 9 | 11 | degree |
| | θ_{\perp} | $P_o = 5\text{mW}$ | 22 | 30 | 38 | |
| Beam angle accuracy | $\Delta\theta_{//}$ | $P_o = 5\text{mW}$ | - | - | ± 2.0 | |
| | $\Delta\theta_{\perp}$ | $P_o = 5\text{mW}$ | - | - | ± 3.0 | |
| Positional accuracy | $\Delta X, \Delta Y, \Delta Z$ | $P_o = 5\text{mW}$ | - | - | ± 60 | μm |
| Differential efficiency | η | - | 0.2 | 0.5 | 0.8 | mW/mA |
| Astigmatism | As | $P_o = 5\text{mW}$ | - | - | - | μm |



9. SLD65018260

■ Application : Barcode Scanner, Sensor

■ Features

- Lasing wavelength : $\lambda_p = 650\text{nm}$
- Optical output power : $P_o = 5\text{mW (CW)}$
- Package type : TO-18 [$\Phi 5.6$]
- Built-in photodiode for optical power monitoring
- InGaAlP laser with multi-quantum well structure

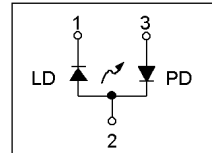

[SLD65018260]

■ Absolute maximum ratings [$T_c = 25^\circ\text{C}$]

| Parameter | Symbol | Value | Unit |
|-----------------------|-----------|-----------|------------------|
| Optical output power | P_o | 7 | mW |
| LD reverse voltage | VR | 2 | V |
| PD reverse voltage | VR | 30 | V |
| Operating temperature | T_{opr} | -10 ~ +60 | $^\circ\text{C}$ |
| Storage temperature | T_{stg} | -40 ~ +85 | $^\circ\text{C}$ |

■ Electrical & optical characteristics [$T_c = 25^\circ\text{C}$]

| Parameter | Symbol | Condition | Min. | Typ. | Max. | Unit |
|-------------------------|--------------------------------|--------------------|------|------|-----------|---------------|
| Optical output power | P_o | - | - | 5 | - | mW |
| Threshold current | I_{th} | - | - | 30 | 40 | mA |
| Operating current | I_{op} | $P_o = 5\text{mW}$ | - | 40 | 50 | mA |
| Operating voltage | V_{op} | $P_o = 5\text{mW}$ | - | 2.2 | 2.6 | V |
| Monitor current | I_m | $P_o = 5\text{mW}$ | 0.1 | 0.2 | 0.5 | mA |
| Lasing wavelength | λ | $P_o = 5\text{mW}$ | 648 | 651 | 654 | nm |
| Beam divergence | $\theta_{//}$ | $P_o = 5\text{mW}$ | 7 | 8 | 9.5 | degree |
| | θ_{\perp} | $P_o = 5\text{mW}$ | 26 | 29 | 32 | |
| Beam angle accuracy | $\Delta\theta_{//}$ | $P_o = 5\text{mW}$ | - | - | ± 1.5 | |
| | $\Delta\theta_{\perp}$ | $P_o = 5\text{mW}$ | - | - | ± 2.5 | |
| Positional accuracy | $\Delta X, \Delta Y, \Delta Z$ | $P_o = 5\text{mW}$ | - | - | ± 60 | μm |
| Differential efficiency | η | - | 0.4 | 0.65 | 0.9 | mW/mA |
| Astigmatism | As | $P_o = 5\text{mW}$ | - | 8 | 10 | μm |



10. SLD65018271

■ Application : DVD-P, DVD-R

■ Features

- Lasing wavelength : $\lambda_p = 650\text{nm}$
- Optical output power : $P_o = 5\text{mW (CW)}$
- Package type : TO-18 [$\Phi 5.6$]
- Built-in photodiodes for optical power monitoring
- InGaAlP laser with multi-quantum well structure

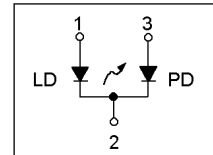

[SLD65018271]

■ Absolute maximum ratings [$T_c = 25^\circ\text{C}$]

| Parameter | Symbol | Value | Unit |
|-----------------------|--------|-----------|------------------|
| Optical output power | P_o | 7 | mW |
| LD reverse voltage | VR | 2 | V |
| PD reverse voltage | VR | 30 | V |
| Operating temperature | Topr | -10 ~ +70 | $^\circ\text{C}$ |
| Storage temperature | Tstg | -40 ~ +85 | $^\circ\text{C}$ |

■ Electrical & optical characteristics [$T_c = 25^\circ\text{C}$]

| Parameter | Symbol | Condition | Min. | Typ. | Max. | Unit |
|-------------------------|--------------------------------|--------------------|------|------|-----------|---------------|
| Optical output power | P_o | - | - | 5 | - | mW |
| Threshold current | I_{th} | - | - | 30 | 40 | mA |
| Operating current | I_{op} | $P_o = 5\text{mW}$ | - | 40 | 50 | mA |
| Operating voltage | V_{op} | $P_o = 5\text{mW}$ | - | 2.2 | 2.6 | V |
| Monitor current | I_m | $P_o = 5\text{mW}$ | 0.1 | 0.2 | 0.4 | mA |
| Lasing wavelength | λ | $P_o = 5\text{mW}$ | 645 | 654 | 657 | nm |
| Beam divergence | $\theta_{//}$ | $P_o = 5\text{mW}$ | 7 | 8 | 10 | degree |
| | θ_{\perp} | $P_o = 5\text{mW}$ | 25 | 28 | 32 | |
| Beam angle accuracy | $\Delta\theta_{//}$ | $P_o = 5\text{mW}$ | - | - | ± 1.5 | |
| | $\Delta\theta_{\perp}$ | $P_o = 5\text{mW}$ | - | - | ± 2.5 | |
| Positional accuracy | $\Delta X, \Delta Y, \Delta Z$ | $P_o = 5\text{mW}$ | - | - | ± 60 | μm |
| Differential efficiency | η | - | 0.4 | 0.65 | 0.9 | mW/mA |
| Astigmatism | A_s | $P_o = 5\text{mW}$ | - | - | 12 | μm |



11. SLD65018271L

■ Application : DVD-P, DVD-R

■ Features

- Lasing wavelength : $\lambda_p = 650\text{nm}$
- Optical output power : $P_o = 5\text{mW (CW)}$
- Package type : TO-18 [$\Phi 5.6$]
- Built-in photodiodes for optical power monitoring
- InGaAlP laser with multi-quantum well structure

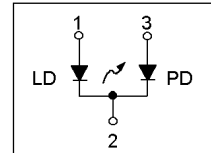

[SLD65018271L]

■ Absolute maximum ratings [$T_c = 25^\circ\text{C}$]

| Parameter | Symbol | Value | Unit |
|-----------------------|-----------|-----------|------------------|
| Optical output power | P_o | 7 | mW |
| LD reverse voltage | VR | 2 | V |
| PD reverse voltage | VR | 30 | V |
| Operating temperature | T_{opr} | -10 ~ +70 | $^\circ\text{C}$ |
| Storage temperature | T_{stg} | -40 ~ +85 | $^\circ\text{C}$ |

■ Electrical & optical characteristics [$T_c = 25^\circ\text{C}$]

| Parameter | Symbol | Condition | Min. | Typ. | Max. | Unit |
|-------------------------|--------------------------------|--------------------|------|------|-----------|---------------|
| Optical output power | P_o | - | - | 5 | - | mW |
| Threshold current | I_{th} | - | - | 30 | 35 | mA |
| Operating current | I_{op} | $P_o = 5\text{mW}$ | - | 37 | 40 | mA |
| Operating voltage | V_{op} | $P_o = 5\text{mW}$ | - | 2.2 | 2.6 | V |
| Monitor current | I_m | $P_o = 5\text{mW}$ | 0.1 | 0.2 | 0.3 | mA |
| Lasing wavelength | λ | $P_o = 5\text{mW}$ | 645 | 654 | 657 | nm |
| Beam divergence | $\theta_{//}$ | $P_o = 5\text{mW}$ | 7 | 8 | 10 | degree |
| | θ_{\perp} | $P_o = 5\text{mW}$ | 25 | 28 | 33 | |
| Beam angle accuracy | $\Delta\theta_{//}$ | $P_o = 5\text{mW}$ | - | - | ± 1.5 | |
| | $\Delta\theta_{\perp}$ | $P_o = 5\text{mW}$ | - | - | ± 2.5 | |
| Positional accuracy | $\Delta X, \Delta Y, \Delta Z$ | $P_o = 5\text{mW}$ | - | - | ± 60 | μm |
| Differential efficiency | η | - | 0.5 | 0.7 | 0.9 | mW/mA |
| Astigmatism | A_s | $P_o = 5\text{mW}$ | - | - | 12 | μm |



12. SLD65018271M

■ Application : DVD-P, DVD-R

■ Features

- Lasing wavelength : $\lambda_p = 650\text{nm}$
- Optical output power : $P_o = 5\text{mW (CW)}$
- Package type : TO-18 [$\Phi 5.6$]
- Built-in photodiodes for optical power monitoring
- Multi-mode laser
- InGaAIP laser with multi-quantum well structure

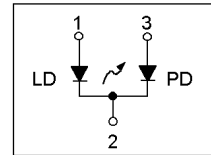

[SLD65018271M]

■ Absolute maximum ratings [$T_c = 25^\circ\text{C}$]

| Parameter | Symbol | Value | Unit |
|-----------------------|-----------|-----------|------------------|
| Optical output power | P_o | 7 | mW |
| LD reverse voltage | VR | 2 | V |
| PD reverse voltage | VR | 30 | V |
| Operating temperature | T_{opr} | -10 ~ +70 | $^\circ\text{C}$ |
| Storage temperature | T_{stg} | -40 ~ +85 | $^\circ\text{C}$ |

■ Electrical & optical characteristics [$T_c = 25^\circ\text{C}$]

| Parameter | Symbol | Condition | Min. | Typ. | Max. | Unit |
|-------------------------|--------------------------------|--------------------|------|------|-----------|---------------|
| Optical output power | P_o | - | - | 5 | - | mW |
| Threshold current | I_{th} | - | - | 59 | 75 | mA |
| Operating current | I_{op} | $P_o = 5\text{mW}$ | - | 72 | 90 | mA |
| Operating voltage | V_{op} | $P_o = 5\text{mW}$ | - | 2.2 | 2.6 | V |
| Monitor current | I_m | $P_o = 5\text{mW}$ | 0.1 | 0.2 | 0.5 | mA |
| Lasing wavelength | λ | $P_o = 5\text{mW}$ | 645 | 658 | 660 | nm |
| Beam divergence | $\theta_{//}$ | $P_o = 5\text{mW}$ | 7 | 8 | 12 | degree |
| | θ_{\perp} | $P_o = 5\text{mW}$ | 26 | 35 | 40 | |
| Beam angle accuracy | $\Delta\theta_{//}$ | $P_o = 5\text{mW}$ | - | - | ± 1.5 | |
| | $\Delta\theta_{\perp}$ | $P_o = 5\text{mW}$ | - | - | ± 2.5 | |
| Positional accuracy | $\Delta X, \Delta Y, \Delta Z$ | $P_o = 5\text{mW}$ | - | - | ± 60 | μm |
| Differential efficiency | η | - | 0.4 | 0.6 | 0.8 | mW/mA |
| Astigmatism | A_s | $P_o = 5\text{mW}$ | - | - | 15 | μm |



13. SLD65018371

Application : DVD-Combo, Industrial barcode scanner

Features

- Lasing wavelength : $\lambda_p = 650\text{nm}$
- Optical output power : $P_o = 7\text{mW (CW)}$
- Package type : TO-18 [$\Phi 5.6$]
- Built-in photodiode for optical power monitoring
- High power laser
- InGaAlP laser with multi-quantum well structure

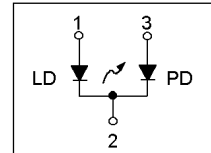

[SLD65018371]

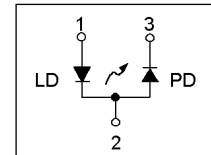

[SLD65018372]

Absolute maximum ratings [$T_c = 25^\circ\text{C}$]

| Parameter | Symbol | Value | Unit |
|-----------------------|-----------|-----------|------------------|
| Optical output power | P_o | 10 | mW |
| LD reverse voltage | VR | 2 | V |
| PD reverse voltage | VR | 30 | V |
| Operating temperature | T_{opr} | -10 ~ +70 | $^\circ\text{C}$ |
| Storage temperature | T_{stg} | -40 ~ +85 | $^\circ\text{C}$ |

Electrical & optical characteristics [$T_c = 25^\circ\text{C}$]

| Parameter | Symbol | Condition | Min. | Typ. | Max. | Unit |
|-------------------------|--------------------------------|--------------------|------|------|-----------|---------------|
| Optical output power | P_o | - | - | 7 | - | mW |
| Threshold current | I_{th} | - | - | 27 | 45 | mA |
| Operating current | I_{op} | $P_o = 7\text{mW}$ | - | 37 | 43 | mA |
| Operating voltage | V_{op} | $P_o = 7\text{mW}$ | - | 2.25 | 2.6 | V |
| Monitor current | I_m | $P_o = 7\text{mW}$ | 0.1 | 0.15 | 0.5 | mA |
| Lasing wavelength | λ | $P_o = 7\text{mW}$ | 645 | 655 | 660 | nm |
| Beam divergence | $\theta_{//}$ | $P_o = 7\text{mW}$ | 7 | 9 | 10 | degree |
| | θ_{\perp} | $P_o = 7\text{mW}$ | 24 | 26.5 | 33 | |
| Beam angle accuracy | $\Delta\theta_{//}$ | $P_o = 7\text{mW}$ | - | - | ± 1.5 | |
| | $\Delta\theta_{\perp}$ | $P_o = 7\text{mW}$ | - | - | ± 2.5 | |
| Positional accuracy | $\Delta X, \Delta Y, \Delta Z$ | $P_o = 7\text{mW}$ | - | - | ± 60 | μm |
| Differential efficiency | η | - | 0.5 | 0.75 | 1.0 | mW/mA |
| Astigmatism | As | $P_o = 7\text{mW}$ | - | - | 15 | μm |



14. SLD65018871 - Preliminary

■ Application : DVD-RW, DVD-RAM

■ Features

- Lasing wavelength : $\lambda_p = 650\text{nm}$
- Optical output power : $P_o = 50\text{mW}$ (CW)
- Package type : TO-18 [$\Phi 5.6$]
- Built-in photodiode for optical power monitoring
- High power laser

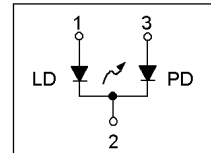

[SLD65018871]

■ Absolute maximum ratings [$T_c = 25^\circ\text{C}$]

| Parameter | Symbol | Value | Unit |
|-----------------------|-----------|-----------|------------------|
| Optical output power | P_o | 70 | mW |
| LD reverse voltage | VR | 2 | V |
| PD reverse voltage | VR | 30 | V |
| Operating temperature | T_{opr} | -10 ~ +70 | $^\circ\text{C}$ |
| Storage temperature | T_{stg} | -40 ~ +85 | $^\circ\text{C}$ |

■ Electrical & optical characteristics [$T_c = 25^\circ\text{C}$]

| Parameter | Symbol | Condition | Min. | Typ. | Max. | Unit |
|-------------------------|--------------------------------|---------------------|------|------|-----------|---------------|
| Optical output power | P_o | - | - | 50 | - | mW |
| Threshold current | I_{th} | - | - | 35 | 55 | mA |
| Operating current | I_{op} | $P_o = 50\text{mW}$ | - | 85 | 100 | mA |
| Operating voltage | V_{op} | $P_o = 50\text{mW}$ | - | 2.5 | 2.95 | V |
| Monitor current | I_m | $P_o = 50\text{mW}$ | - | - | - | mA |
| Lasing wavelength | λ | $P_o = 50\text{mW}$ | 650 | 656 | 660 | nm |
| Beam divergence | $\theta_{//}$ | $P_o = 50\text{mW}$ | 6 | 8.5 | 10 | degree |
| | θ_{\perp} | $P_o = 50\text{mW}$ | 19 | 22 | 25 | |
| Beam angle accuracy | $\Delta\theta_{//}$ | $P_o = 50\text{mW}$ | - | - | ± 2.0 | |
| | $\Delta\theta_{\perp}$ | $P_o = 50\text{mW}$ | - | - | ± 3.0 | |
| Positional accuracy | $\Delta X, \Delta Y, \Delta Z$ | $P_o = 50\text{mW}$ | - | - | - | μm |
| Differential efficiency | η | - | 0.8 | 1.0 | - | mW/mA |
| Astigmatism | As | $P_o = 50\text{mW}$ | - | - | - | μm |



15. SLD78018261

■ Application : CD-P, CD-R

■ Features

- Lasing wavelength : $\lambda_p = 780\text{nm}$
- Optical output power : $P_o = 3\text{mW (CW)}$
- Package type : TO-18 [$\Phi 5.6$]
- Built-in photodiode for optical power monitoring
- AlGaAs laser with multi-quantum well structure

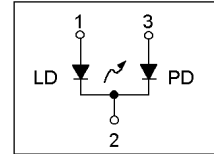

[SLD78018261]

■ Absolute maximum ratings [$T_c = 25^\circ\text{C}$]

| Parameter | Symbol | Value | Unit |
|-----------------------|-----------|-----------|------------------|
| Optical output power | P_o | 5 | mW |
| LD reverse voltage | VR | 2 | V |
| PD reverse voltage | VR | 30 | V |
| Operating temperature | T_{opr} | -10 ~ +70 | $^\circ\text{C}$ |
| Storage temperature | T_{stg} | -40 ~ +85 | $^\circ\text{C}$ |

■ Electrical & optical characteristics [$T_c = 25^\circ\text{C}$]

| Parameter | Symbol | Condition | Min. | Typ. | Max. | Unit |
|-------------------------|--------------------------------|--------------------|------|------|-----------|---------------|
| Optical output power | P_o | - | - | 3 | - | mW |
| Threshold current | I_{th} | - | - | 40 | 50 | mA |
| Operating current | I_{op} | $P_o = 3\text{mW}$ | - | 46 | 55 | mA |
| Operating voltage | V_{op} | $P_o = 3\text{mW}$ | - | 1.9 | 2.3 | V |
| Monitor current | I_m | $P_o = 3\text{mW}$ | 0.1 | 0.2 | 0.5 | mA |
| Lasing wavelength | λ | $P_o = 3\text{mW}$ | 770 | 788 | 810 | nm |
| Beam divergence | $\theta_{//}$ | $P_o = 3\text{mW}$ | 10 | 12.5 | 14 | degree |
| | θ_{\perp} | $P_o = 3\text{mW}$ | 20 | 36 | 40 | |
| Beam angle accuracy | $\Delta\theta_{//}$ | $P_o = 3\text{mW}$ | - | - | ± 1.5 | |
| | $\Delta\theta_{\perp}$ | $P_o = 3\text{mW}$ | - | - | ± 3.0 | |
| Positional accuracy | $\Delta X, \Delta Y, \Delta Z$ | $P_o = 3\text{mW}$ | - | - | ± 60 | μm |
| Differential efficiency | η | - | 0.2 | 0.4 | 0.6 | mW/mA |
| Astigmatism | As | $P_o = 3\text{mW}$ | - | - | - | μm |



16. SLD78018261F

■ Application : CD-P

■ Features

- Lasing wavelength : $\lambda_p = 780\text{nm}$
- Optical output power : $P_o = 3\text{mW (CW)}$
- Package type : Plastic mold Package
- Built-in photodiodes for optical power monitoring
- AlGaAs laser with multi-quantum well structure

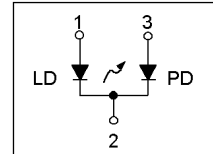

[SLD78018261F]

■ Absolute maximum ratings [$T_c = 25^\circ\text{C}$]

| Parameter | Symbol | Value | Unit |
|-----------------------|-----------|-----------|------------------|
| Optical output power | P_o | 5 | mW |
| LD reverse voltage | VR | 2 | V |
| PD reverse voltage | VR | 30 | V |
| Operating temperature | T_{opr} | -10 ~ +70 | $^\circ\text{C}$ |
| Storage temperature | T_{stg} | -40 ~ +85 | $^\circ\text{C}$ |

■ Electrical & optical characteristics [$T_c = 25^\circ\text{C}$]

| Parameter | Symbol | Condition | Min. | Typ. | Max. | Unit |
|-------------------------|--------------------------------|--------------------|------|------|-----------|---------------|
| Optical output power | P_o | - | - | 3 | - | mW |
| Threshold current | I_{th} | - | - | 40 | 50 | mA |
| Operating current | I_{op} | $P_o = 3\text{mW}$ | - | 1.9 | 2.3 | mA |
| Operating voltage | V_{op} | $P_o = 3\text{mW}$ | 0.1 | 0.2 | 0.5 | V |
| Monitor current | I_m | $P_o = 3\text{mW}$ | 770 | 785 | 810 | mA |
| Lasing wavelength | λ | $P_o = 3\text{mW}$ | 9 | 12 | 14 | nm |
| Beam divergence | $\theta_{//}$ | $P_o = 3\text{mW}$ | 20 | 35 | 40 | degree |
| | θ_{\perp} | $P_o = 3\text{mW}$ | - | - | ± 1.5 | |
| Beam angle accuracy | $\Delta\theta_{//}$ | $P_o = 3\text{mW}$ | - | - | ± 3.0 | |
| | $\Delta\theta_{\perp}$ | $P_o = 3\text{mW}$ | - | - | ± 60 | |
| Positional accuracy | $\Delta X, \Delta Y, \Delta Z$ | $P_o = 3\text{mW}$ | 0.2 | 0.35 | 0.6 | μm |
| Differential efficiency | η | - | - | - | - | mW/mA |
| Astigmatism | As | $P_o = 3\text{mW}$ | - | - | - | μm |



17. SLD78018262C

■ Application : LSU (Laser printer)

■ Features

- Lasing wavelength : $\lambda_p = 780\text{nm}$
- Optical output power : $P_o = 3\text{mW (CW)}$
- Package type : TO-18 [$\Phi 5.6$]
- Built-in photodiode for optical power monitoring
- AlGaAs laser with multi-quantum well structure

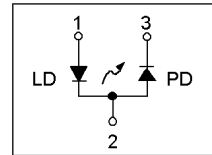

[SLD78018262C]

■ Absolute maximum ratings [$T_c = 25^\circ\text{C}$]

| Parameter | Symbol | Value | Unit |
|-----------------------|--------|-----------|------------------|
| Optical output power | P_o | 5 | mW |
| LD reverse voltage | VR | 2 | V |
| PD reverse voltage | VR | 30 | V |
| Operating temperature | Topr | -10 ~ +60 | $^\circ\text{C}$ |
| Storage temperature | Tstg | -40 ~ +85 | $^\circ\text{C}$ |

■ Electrical & optical characteristics [$T_c = 25^\circ\text{C}$]

| Parameter | Symbol | Condition | Min. | Typ. | Max. | Unit |
|-------------------------|--------------------------------|--------------------|------|------|-----------|---------------|
| Optical output power | P_o | - | - | 3 | - | mW |
| Threshold current | I_{th} | - | - | 40 | 50 | mA |
| Operating current | I_{op} | $P_o = 3\text{mW}$ | - | 45 | 55 | mA |
| Operating voltage | V_{op} | $P_o = 3\text{mW}$ | - | 1.9 | 2.3 | V |
| Monitor current | I_m | $P_o = 3\text{mW}$ | 0.15 | 0.2 | 0.47 | mA |
| Lasing wavelength | λ | $P_o = 3\text{mW}$ | 770 | 787 | 810 | nm |
| Beam divergence | $\theta_{//}$ | $P_o = 3\text{mW}$ | 10 | 12.5 | 14 | degree |
| | θ_{\perp} | $P_o = 3\text{mW}$ | 30 | 36 | 40 | |
| Beam angle accuracy | $\Delta\theta_{//}$ | $P_o = 3\text{mW}$ | - | - | ± 1.5 | |
| | $\Delta\theta_{\perp}$ | $P_o = 3\text{mW}$ | - | - | ± 2.5 | |
| Positional accuracy | $\Delta X, \Delta Y, \Delta Z$ | $P_o = 3\text{mW}$ | - | - | ± 60 | μm |
| Differential efficiency | η | - | 0.3 | 0.42 | 0.6 | mW/mA |
| Astigmatism | As | $P_o = 3\text{mW}$ | - | - | - | μm |



18. SLD78018271D

■ Application : Disk-man (CD-P)

■ Features

- Lasing wavelength : $\lambda_p = 780\text{nm}$
- Optical output power : $P_o = 3\text{mW}$ (CW)
- Package type : TO-18 [$\Phi 5.6$]
- Built-in photodiode for optical power monitoring
- AlGaAs laser with multi-quantum well structure

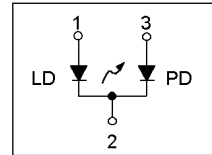

[SLD78018271D]

■ Absolute maximum ratings [$T_c = 25^\circ\text{C}$]

| Parameter | Symbol | Value | Unit |
|-----------------------|--------|-----------|------------------|
| Optical output power | P_o | 4 | mW |
| LD reverse voltage | VR | 2 | V |
| PD reverse voltage | VR | 30 | V |
| Operating temperature | Topr | -10 ~ +70 | $^\circ\text{C}$ |
| Storage temperature | Tstg | -40 ~ +85 | $^\circ\text{C}$ |

■ Electrical & optical characteristics [$T_c = 25^\circ\text{C}$]

| Parameter | Symbol | Condition | Min. | Typ. | Max. | Unit |
|-------------------------|--------------------------------|--------------------|------|------|-----------|---------------|
| Optical output power | P_o | - | - | 3 | - | mW |
| Threshold current | I_{th} | - | - | 23 | 25 | mA |
| Operating current | I_{op} | $P_o = 3\text{mW}$ | - | 26 | 28 | mA |
| Operating voltage | V_{op} | $P_o = 3\text{mW}$ | - | 1.9 | 2.3 | V |
| Monitor current | I_m | $P_o = 3\text{mW}$ | 0.1 | 0.2 | 0.6 | mA |
| Lasing wavelength | λ | $P_o = 3\text{mW}$ | 770 | 785 | 810 | nm |
| Beam divergence | $\theta_{//}$ | $P_o = 3\text{mW}$ | 7.5 | 9.8 | 15 | degree |
| | θ_{\perp} | $P_o = 3\text{mW}$ | 20 | 33 | 45 | |
| Beam angle accuracy | $\Delta\theta_{//}$ | $P_o = 3\text{mW}$ | - | - | ± 1.5 | |
| | $\Delta\theta_{\perp}$ | $P_o = 3\text{mW}$ | - | - | ± 2.5 | |
| Positional accuracy | $\Delta X, \Delta Y, \Delta Z$ | $P_o = 3\text{mW}$ | - | - | ± 60 | μm |
| Differential efficiency | η | - | 0.7 | 0.89 | 1.1 | mW/mA |
| Astigmatism | As | $P_o = 3\text{mW}$ | - | - | - | μm |



19. SLD78018360P

Application : LSU (Laser printer)

Features

- Lasing wavelength : $\lambda_p = 780\text{nm}$
- Optical output power : $P_o = 5\text{mW (CW)}$
- Package type : TO-18 [$\Phi 5.6$]
- Built-in photodiode for optical power monitoring
- AlGaAs laser with multi-quantum well structure

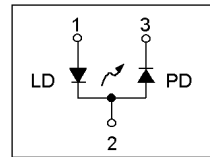
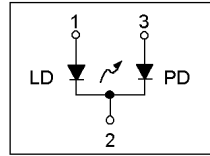
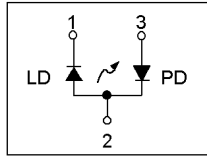

Absolute maximum ratings [$T_c = 25^\circ\text{C}$]

| Parameter | Symbol | Value | Unit |
|-----------------------|-----------|-----------|------------------|
| Optical output power | P_o | 7 | mW |
| LD reverse voltage | VR | 2 | V |
| PD reverse voltage | VR | 30 | V |
| Operating temperature | T_{opr} | -10 ~ +60 | $^\circ\text{C}$ |
| Storage temperature | T_{stg} | -40 ~ +85 | $^\circ\text{C}$ |

Electrical & optical characteristics [$T_c = 25^\circ\text{C}$]

| Parameter | Symbol | Condition | Min. | Typ. | Max. | Unit |
|-------------------------|--|---|------|------|-----------|---------------|
| Optical output power | P_o | - | - | 5 | - | mW |
| Threshold current | I_{th} | - | - | 30 | 45 | mA |
| Operating current | I_{op} | $P_o = 5\text{mW}$ | - | 45 | 60 | mA |
| Operating voltage | V_{op} | $P_o = 5\text{mW}$ | - | 1.9 | 2.3 | V |
| Monitor current | I_m | $P_o = 5\text{mW}$ | 0.2 | 0.4 | 1.0 | mA |
| Lasing wavelength | λ | $P_o = 5\text{mW}$ | 770 | 785 | 810 | nm |
| Beam divergence | $\theta_{//}$ | $P_o = 5\text{mW}$ | 8 | 11 | 15 | degree |
| | θ_{\perp} | $P_o = 5\text{mW}$ | 25 | 29 | 33 | |
| Beam angle accuracy | $\Delta\theta_{//}$ | $P_o = 5\text{mW}$ | - | - | ± 2.0 | |
| | $\Delta\theta_{\perp}$ | $P_o = 5\text{mW}$ | - | - | ± 2.5 | |
| Positional accuracy | $\Delta X, \Delta Y, \Delta Z$ | $P_o = 5\text{mW}$ | - | - | ± 60 | μm |
| Differential efficiency | η | - | 0.2 | 0.4 | 0.6 | mW/mA |
| Astigmatism | $\frac{(P_{max}-P_{min}) \times 100}{P_{min}}$ | 100Hz pulse rate at .9 & .1 duty cycle | - | 5% | 10% | μm |



20. SLD78018371

■ Application : CD-R, CD-P

■ Features

- Lasing wavelength : $\lambda_p = 780\text{nm}$
- Optical output power : $P_o = 7\text{mW (CW)}$
- Package type : TO-18 [$\Phi 5.6$]
- Built-in photodiode for optical power monitoring
- High power laser
- AlGaAs laser with multi-quantum well structure

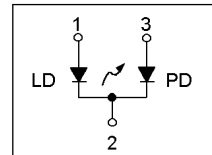

[SLD78018371]

■ Absolute maximum ratings [$T_c = 25^\circ\text{C}$]

| Parameter | Symbol | Value | Unit |
|-----------------------|-----------|-----------|------------------|
| Optical output power | P_o | 10 | mW |
| LD reverse voltage | VR | 2 | V |
| PD reverse voltage | VR | 30 | V |
| Operating temperature | T_{opr} | -10 ~ +70 | $^\circ\text{C}$ |
| Storage temperature | T_{stg} | -40 ~ +85 | $^\circ\text{C}$ |

■ Electrical & optical characteristics [$T_c = 25^\circ\text{C}$]

| Parameter | Symbol | Condition | Min. | Typ. | Max. | Unit |
|-------------------------|--------------------------------|--------------------|------|------|-----------|---------------|
| Optical output power | P_o | - | - | 7 | - | mW |
| Threshold current | I_{th} | - | - | 40 | 50 | mA |
| Operating current | I_{op} | $P_o = 7\text{mW}$ | - | 47 | 63 | mA |
| Operating voltage | V_{op} | $P_o = 7\text{mW}$ | - | 2.0 | 2.3 | V |
| Monitor current | I_m | $P_o = 7\text{mW}$ | 0.1 | 0.2 | 0.5 | mA |
| Lasing wavelength | λ | $P_o = 7\text{mW}$ | 780 | 786 | 810 | nm |
| Beam divergence | $\theta_{//}$ | $P_o = 7\text{mW}$ | 8 | 12 | 14 | degree |
| | θ_{\perp} | $P_o = 7\text{mW}$ | 35 | 41 | 45 | |
| Beam angle accuracy | $\Delta\theta_{//}$ | $P_o = 7\text{mW}$ | - | - | ± 1.5 | |
| | $\Delta\theta_{\perp}$ | $P_o = 7\text{mW}$ | - | - | ± 3.0 | |
| Positional accuracy | $\Delta X, \Delta Y, \Delta Z$ | $P_o = 7\text{mW}$ | - | - | ± 60 | μm |
| Differential efficiency | η | - | 0.6 | 0.86 | 1.1 | mW/mA |
| Astigmatism | As | $P_o = 7\text{mW}$ | - | - | 15 | μm |



21. SLD78018971 - Preliminary

■ Application : CD-RW

■ Features

- Lasing wavelength : $\lambda_p = 785\text{nm}$
- Optical output power : $P_o = 100\text{mW}$ (CW), $P_o = 220\text{mW}$ (Pulse)
- Package type : TO-18 [Φ 5.6]
- Built-in photodiode for optical power monitoring
- High power laser

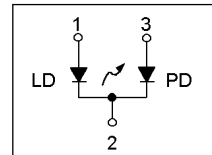

[SLD78018971]

■ Absolute maximum ratings [$T_c = 25^\circ\text{C}$]

| Parameter | Symbol | Value | Unit |
|-----------------------|--------|-------------------------------------|------------------|
| Optical output power | P_o | 100 | mW |
| LD reverse voltage | VR | 2 | V |
| PD reverse voltage | VR | 30 | V |
| Operating temperature | Topr | -10 ~ +65 (CW) -10 ~ +70 (Pulse) | $^\circ\text{C}$ |
| Storage temperature | Tstg | -40 ~ +85 | $^\circ\text{C}$ |

■ Electrical & optical characteristics [$T_c = 25^\circ\text{C}$]

| Parameter | Symbol | Condition | Min. | Typ. | Max. | Unit |
|-------------------------|--------------------------------|---------------------|------|------|-----------|---------------|
| Optical output power | P_o | - | - | 90 | - | mW |
| Threshold current | I_{th} | - | - | 45 | 55 | mA |
| Operating current | I_{op} | $P_o = 90\text{mW}$ | - | 130 | 150 | mA |
| Operating voltage | V_{op} | $P_o = 90\text{mW}$ | - | 2.3 | 2.5 | V |
| Monitor current | I_m | $P_o = 90\text{mW}$ | - | - | - | mA |
| Lasing wavelength | λ | $P_o = 90\text{mW}$ | 780 | 784 | 788 | nm |
| Beam divergence | $\theta_{//}$ | $P_o = 90\text{mW}$ | 7.5 | 9 | 10 | degree |
| | θ_{\perp} | $P_o = 90\text{mW}$ | 14 | 17 | 18 | |
| Beam angle accuracy | $\Delta\theta_{//}$ | $P_o = 90\text{mW}$ | - | - | ± 2.0 | degree |
| | $\Delta\theta_{\perp}$ | $P_o = 90\text{mW}$ | - | - | ± 2.5 | |
| Positional accuracy | $\Delta X, \Delta Y, \Delta Z$ | $P_o = 90\text{mW}$ | - | - | ± 60 | μm |
| Differential efficiency | η | - | 0.8 | 1.0 | 1.3 | mW/mA |
| Astigmatism | As | $P_o = 90\text{mW}$ | - | - | - | μm |



22. 2 Beam Laser - Preliminary

■ Application : DVD-P, DVD-R

■ Features

- Lasing wavelength : $\lambda_p = 650\text{nm}$ (DVD), 780nm (CD)
- Optical output power : $P_o = 5\text{mW}$ (650nm), 7mW (780nm)
- Package type : TO-18 [$\Phi 5.6$], 4 Pin
- Built-in photodiode for optical power monitoring
- 1 Chip 2 Beam laser : Monolithic

■ Absolute maximum ratings [$T_c = 25^\circ\text{C}$]

| Parameter | Symbol | Value | Unit |
|-----------------------|--------|---------------------|------|
| Optical output power | Po | 7(650nm), 10(780nm) | mW |
| LD reverse voltage | VR | 2 | V |
| PD reverse voltage | VR | 30 | V |
| Operating temperature | Topr | -10 ~ +70 | °C |
| Storage temperature | Tstg | -40 ~ +85 | °C |

■ Electrical & optical characteristics [$T_c = 25^\circ\text{C}$]

| Parameter | Symbol | Condition | DVD (650nm) | | | CD (780nm) | | | Unit |
|-------------------------|--------------------------------|-------------|-------------|------|-----------|------------|------|-----------|---------------|
| | | | Min. | Typ. | Max. | Min. | Typ. | Max. | |
| Optical output power | Po | - | - | 5 | - | - | 7 | - | mW |
| Threshold current | I _{th} | - | - | 55 | 65 | - | 40 | 50 | mA |
| Operating current | I _{op} | Po = 5, 7mW | - | 70 | 75 | - | 55 | 65 | mA |
| Operating voltage | V _{op} | Po = 5, 7mW | - | 2.2 | 2.6 | - | 1.9 | 2.5 | V |
| Monitor current | I _m | Po = 5, 7mW | 0.1 | 0.2 | 0.5 | 0.12 | 0.3 | 0.6 | mA |
| Lasing wavelength | λ | Po = 5, 7mW | 645 | 655 | 660 | 770 | 785 | 800 | nm |
| Beam divergence | $\theta_{//}$ | Po = 5, 7mW | 7 | 8.5 | 11 | 10 | 11 | 15 | degree |
| | θ_{\perp} | Po = 5, 7mW | 31 | 35 | 39 | 34 | 37 | 40 | |
| Beam angle accuracy | $\Delta\theta_{//}$ | Po = 5, 7mW | - | - | ± 1.5 | - | - | ± 2.0 | |
| | $\Delta\theta_{\perp}$ | Po = 5, 7mW | - | - | ± 3.0 | - | - | ± 3.0 | |
| Positional accuracy | $\Delta X, \Delta Y, \Delta Z$ | Po = 5, 7mW | - | - | ± 60 | - | - | ± 60 | μm |
| Beam Tolerance | - | - | - | - | - | - | - | - | μm |
| Differential efficiency | η | - | - | 0.6 | 0.9 | - | 0.4 | 0.7 | mW/mA |
| Astigmatism | As | Po = 5, 7mW | - | - | - | - | - | - | μm |



Samsung Semiconductor Laser

■ Packing

▶ Tray

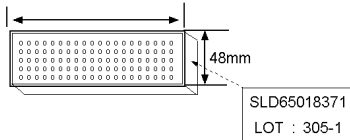

▶ INSIDE BOX

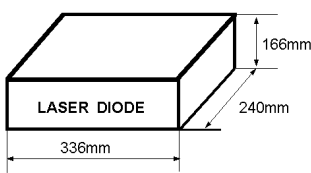

▶ OUTSIDE BOX

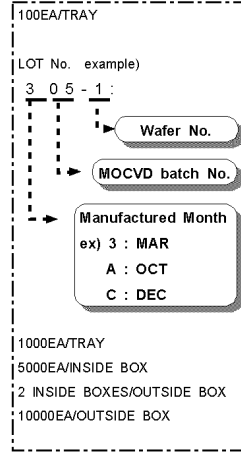
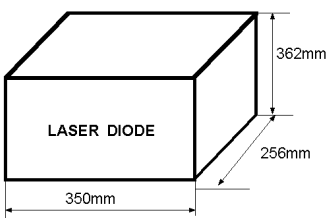

■ Labeling

▶ Top view

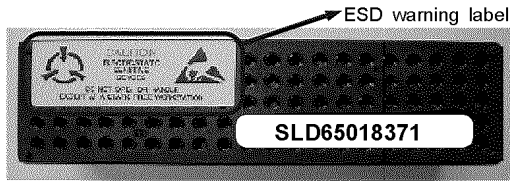

▶ Side view

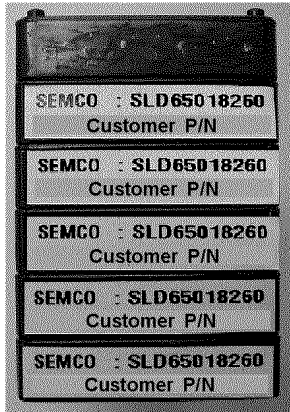

Semco P/N
Customer P/N

▶ Side view

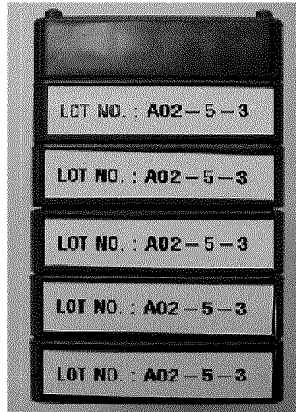

Production lot number