

IS474

Linear Output Type OPIC Light Detector

■ Features

1. Linear output conforming to illuminance
(50 lx to 50000 lx)
2. Conforming to required visual sensitivity characteristics
by means of built-in filter
Peak sensitivity wavelength : TYP. 550 nm
3. Not dependent on kind of light source such as
incandescent lamp and fluorescent lamp
4. Easy-to-mount holder-integral side view type

■ Applications

1. TV sets
2. CRTs of personal computers and others

■ Outline Dimensions

(Unit : mm)

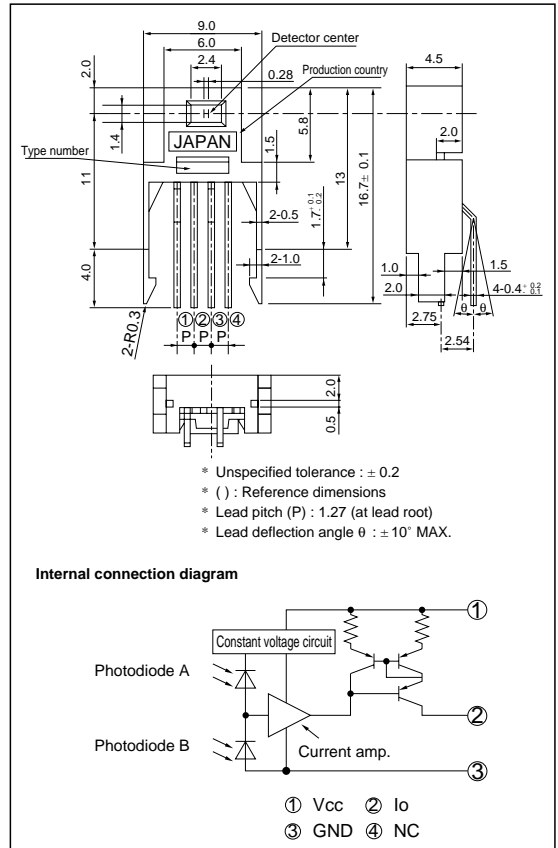

* OPIC (Optical IC) is a trademark of SHARP corporation. An OPIC consists of a light-detecting element and signal-processing circuit integrated onto a single chip.

■ Absolute Maximum Ratings

(Ta=25°C)

Parameter	Symbol	Rating	Unit
Supply voltage	V _{CC}	-0.5 to 8	V
Output current	I _O	-10	mA
Output voltage	V _O	-0.5 to V _{CC}	V
Power dissipation	P	150	mW
Operating temperature	T _{opr}	-25 to +85	°C
Storage temperature	T _{stg}	-40 to +85	°C
^{*1} Soldering temperature	T _{sol}	260	°C

*1 For MAX. 3 seconds at the position shown in the right drawing

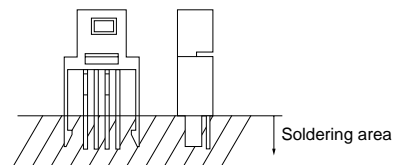

■ Recommended Operating Conditions

Parameter	Symbol	MIN.	MAX.	Unit
Supply voltage	V _{CC}	4.5	5.5	V
Illuminance	E _v *1	100	50 000	lx
Output voltage	V _O	0	V _{CC} - 1.5	V
Operating temperature	T _{opr}	- 10	70	°C

*1 CIE standard light source A (tungsten lamp)

■ Electro-optical Characteristics

(V_{CC}=5V, T_a=25°C)

Parameter	Symbol	Conditions	MIN.	TYP.	MAX.	Unit	Test circuit
Supply current	I _{CC}	*1 E _v = 0 lx	0.2	0.55	1.0	mA	1
Output current 1	I _{O1}	*1 E _v = 100 lx	- 6.0	- 10	- 14	μA	2
Output current 2	I _{O2}	*1 E _v = 1000 lx	- 60	- 100	- 140	μA	2
Output current ratio 1	RI _{O1}	I _{O2} /I _{O1}	9.0	10	11	-	-
Output current 3	I _{O3}	*2 E _v = 100 lx	-	- 11	-	μA	2
Output current 4	I _{O4}	*3 E _v = 100 lx	-	- 10	-	μA	2
Output current ratio 2	RI _{O2}	I _{O3} /I _{O4}	(0.9)	(1.1)	(1.3)	-	-
Dark output current	I _{od}	*1 E _v = 0 lx	-	- 10	- 500	nA	2
Peak sensitivity wavelength	λ _p	-	-	(550)	-	nm	-
Response time (rise)	t _r	R _L = 3.3kΩ	-	12	-	μs	3
Response time (fall)	t _f	R _L = 3.3kΩ	-	30	-	μs	3
Power source fluctuation removability	PSRR1	E _v = 0 lx R _L = 3.3kΩ at 10kHz	-	48	-	dB	-
		E _v = 0 lx R _L = 3.3kΩ at 100kHz	-	39	-	dB	-
		E _v =1000 lx R _L = 3.3kΩ at 10kHz	-	11	-	dB	-

*4

*1 Illuminance by CIE standard light source A (tungsten lamp)

*2 Illuminance by incandescent lamp

*3 Illuminance by fluorescent lamp

*4 Power source fluctuation removability PSRR is defined according to the following formula.

$$PSRR = 20 \log \frac{V_{CC} \text{ ripple voltage}}{V_o \text{ ripple voltage}}$$

Test circuit 1

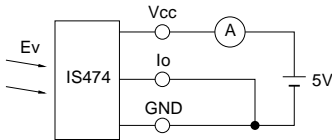

Test circuit 2

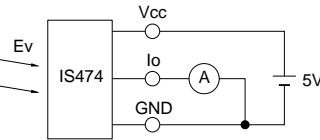

Test circuit 3

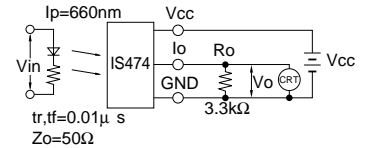

t_r, t_f=0.01μs
Z_o=50Ω

T=500μs
Adjust Vin so that Vo waveform may be of 1.0V amplitude

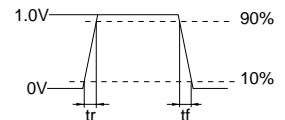

Fig. 1 Total Power Dissipation vs. Ambient Temperature

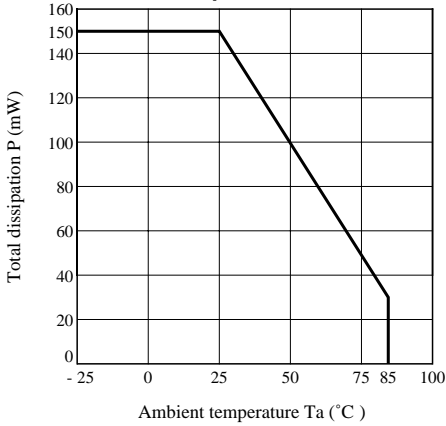

Fig. 2 Output Current vs. Illuminance

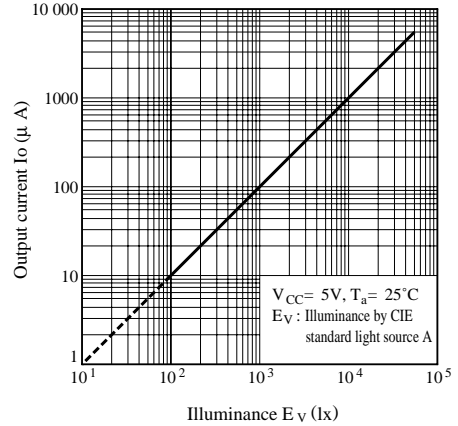

Fig. 3 Spectral Sensitivity

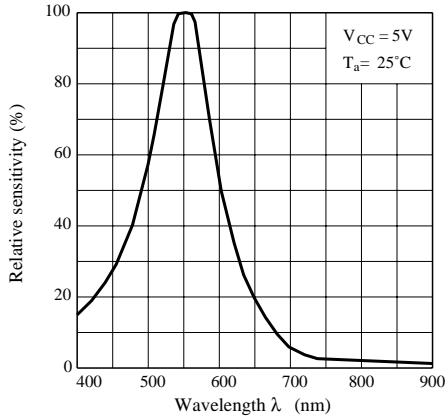

Fig. 4 Relative Output Current vs. Ambient Temperature

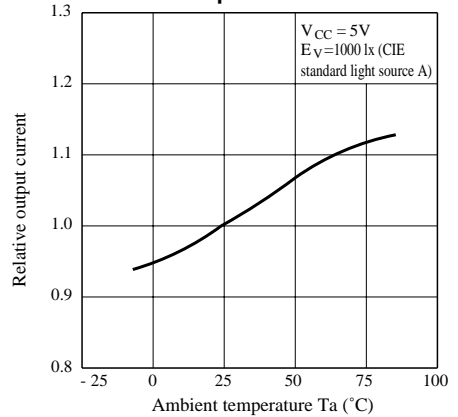

Fig. 5 Dark Output Current vs. Ambient Temperature

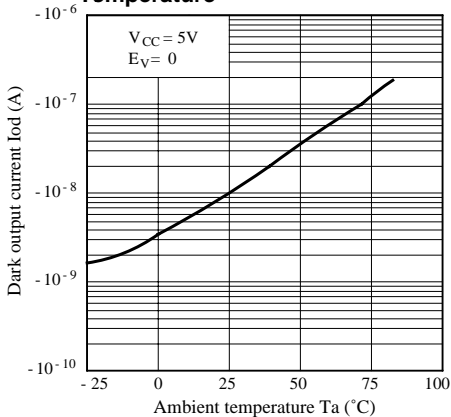

Fig. 6 Output Current vs. Supply Voltage

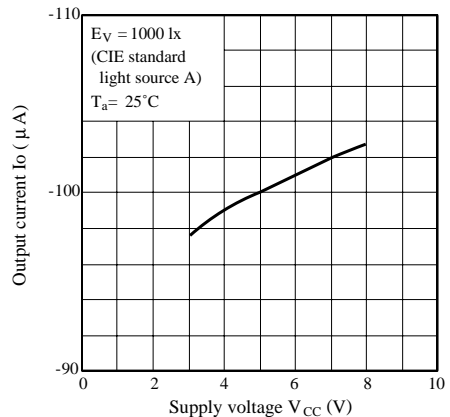
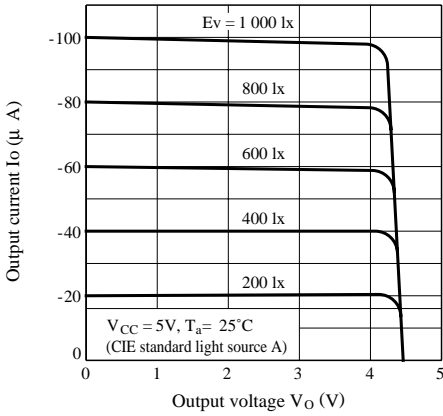

Fig. 7 Output Current vs. Output Voltage



Output Current vs. Output Voltage Test Circuit

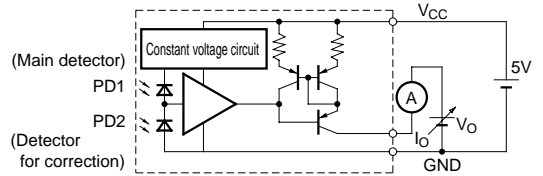

Fig. 8 Supply Current vs. Supply Voltage

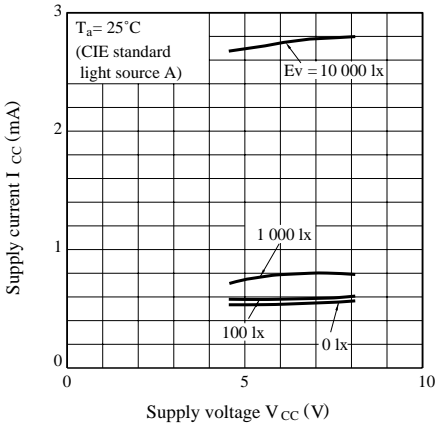

Fig. 9 Supply Current vs. Illuminance

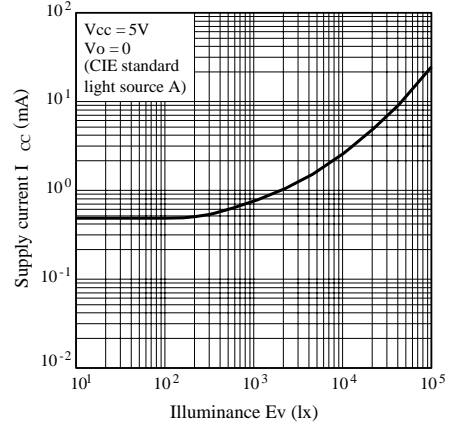
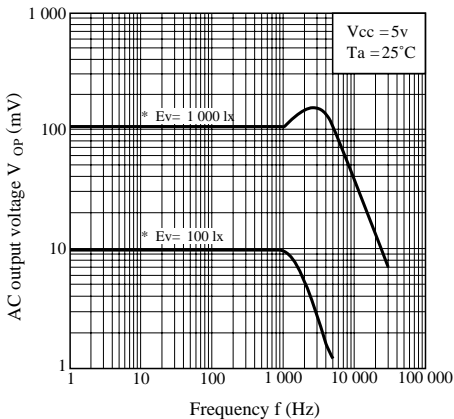
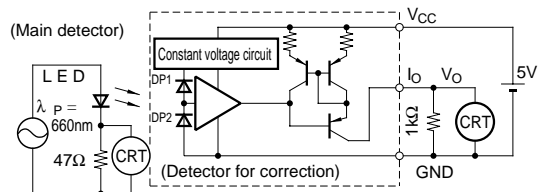

Fig. 10 Frequency Characteristics



Frequency Characteristics Test Circuit



*Incident light quantity E_v : Converted value of DC component of output voltage V_o

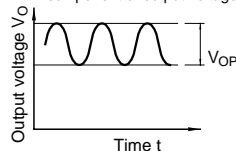

Fig. 11 Radiation Diagram (Right/Left Direction)

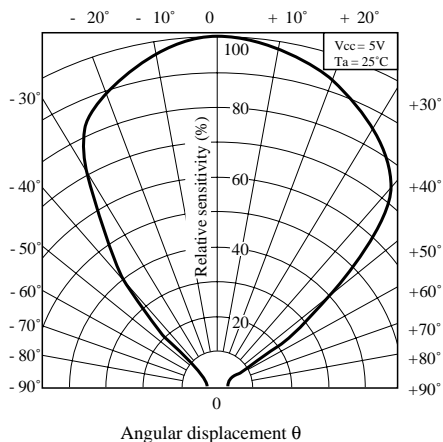
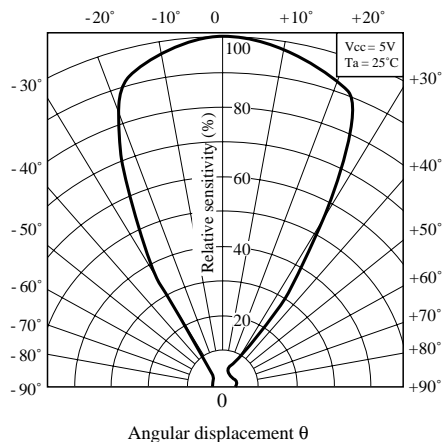
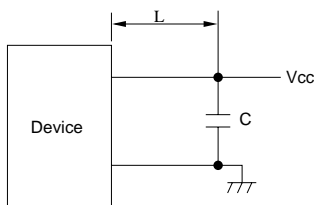

Fig. 12 Radiation Diagram (Top/Bottom Direction)



■ Precautions for Operation

- (1) It is recommended to connect a capacitor between V_{CC} and GND near the device in order to stabilize power supply line



$$L \leq 20 \text{ mm}$$

$$C \geq 0.01 \mu\text{F}$$

2 pieces of photodiodes are built in this device to amplify difference in collector current between them.

Radiation of even light to 2 pieces of photodiodes is recommended.

Radiation of uneven light may cause change of spectral sensitivity or starting failure of the circuit after power is supplied.

(2) Cleaning

- Conduct cleaning as follows.

Solvent dip cleaning : Solvent temperature of 45°C max., dipping time : Within 3 minutes

Ultrasonic cleaning : Elements are affected differently depending on the size of cleaning bath, ultrasonic output, time, size of PWB and mounting method of elements. Conduct trial cleaning on actual operating conditions in advance to make sure that no problem results.

- Use following solvents only.

Solvents : Ethyl alcohol, methyl alcohol and isopropyl alcohol

(3) Soldering

Be sure to perform soldering at values within the maximum ratings. Take care so that not external force is applied to the lead during and immediately after soldering. Do not perform reflow soldering.

- Please refer to the chapter "Precautions for Use". (Page 78 to 93)