

MINIATURE RF ANTENNA SWITCH

MD004 is designed to cover 1200 - 1300MHz, 5W, antenna switch module.

- Small, Easily Mounted Package.
- High Isolation: 30dB Typ.
- Low Transmit Insertion Loss: TX-ANT 0.8dB Typ.
ANT-RX 1.0dB Typ.
- Low Harmonic Output:
- Low Operating Current (TX-ANT ON): 50mA
- Off Through (ANT-RX ON): 0mA

OUTLINE DRAWING

Dimensions in mm

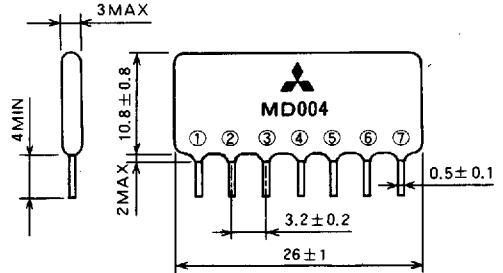

- ① GND
- ② RX
- ③ GND
- ④ BIAS
- ⑤ ANT
- ⑥ GND
- ⑦ TX

EQUIVALENT CIRCUIT

OPERATING MATRIX

Bias condition	TX-ANT	ANT-RX
$I_{bias} = 50\text{mA}$	ON	OFF
$I_{bias} = 0$	OFF	ON

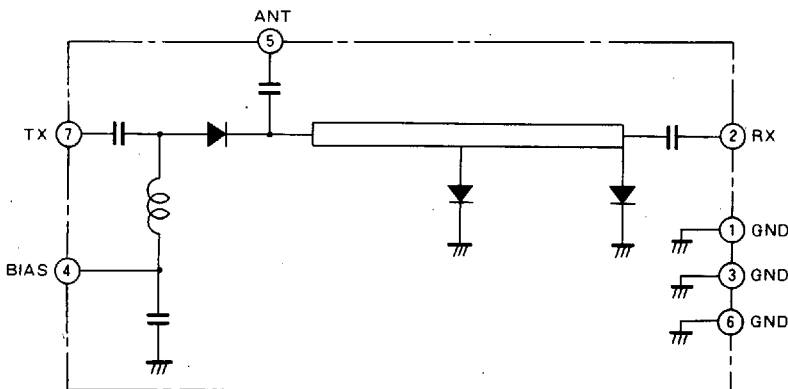

6249829 0017777 858

1200-1300MHz, 5W, ANTENNA SWITCH

ABSOLUTE MAXIMUM RATINGS ($T_a = 25^\circ\text{C}$, unless otherwise noted)

Symbol	Parameter	Rating	Unit
I_{bias}	Bias current	100	mA
P_{in}	Input power	10 @ $T_a \leq 60^\circ\text{C}$	W
T_{stg}	Storage temperature	-30 to 85	$^\circ\text{C}$

ELECTRICAL CHARACTERISTICS ($T_a = 25^\circ\text{C}$)

Symbol	Parameter	Test condition	Limits			Unit
			Min	Typ	Max	
f	Frequency Range		1200		1300	MHz
ISO	Isolation (TX-RX)	$P_{in} = 8\text{ W}$, $I_{bias} = 50\text{ mA}$, ANT port terminated $50\ \Omega$	25	30		dB
α_1	Insertion loss (TX-ANT)	$P_{in} = 8\text{ W}$, $I_{bias} = 50\text{ mA}$, RX port terminated $50\ \Omega$		0.8	1.2	dB
α_2	Insertion loss (ANT-RX)	$P_{in} = 1\text{ mW}$, $I_{bias} = 0$, TX port terminated $50\ \Omega$		1.0	1.5	dB

TESTING CIRCUIT SCHEMATIC (ISO, α_1)

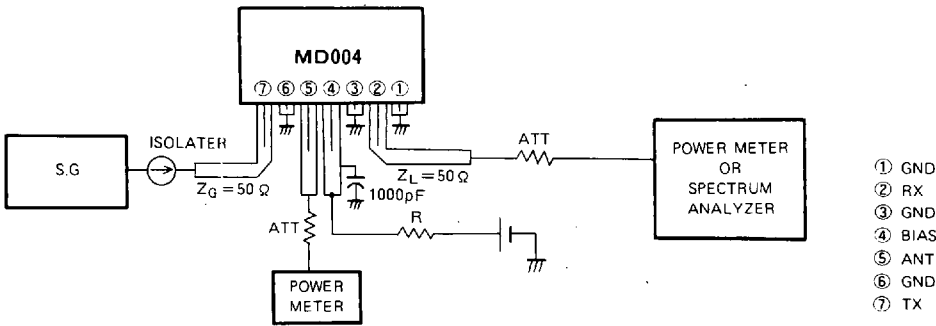

- ① GND
- ② RX
- ③ GND
- ④ BIAS
- ⑤ ANT
- ⑥ GND
- ⑦ TX

TYPICAL PERFORMANCE DATA

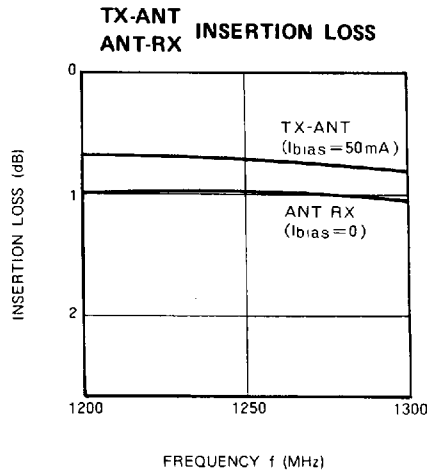
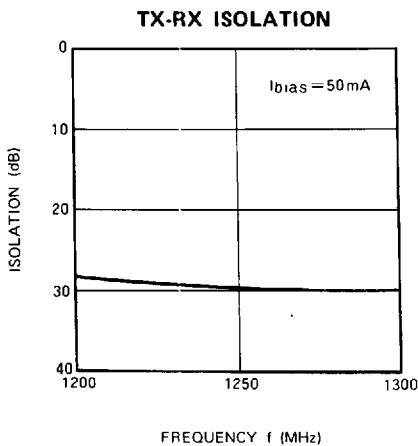

1200-1300MHz, 5W, ANTENNA SWITCH

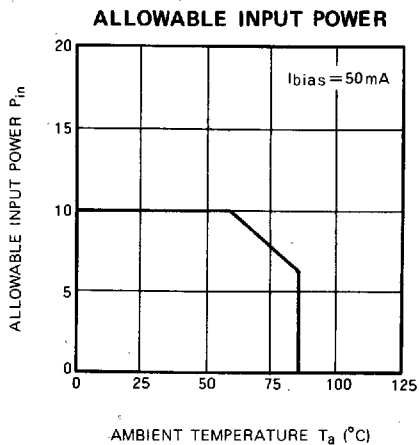
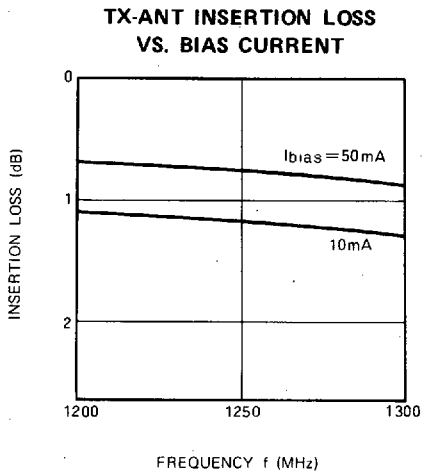

Recommended Practical Design

Fig. A shows a practical circuit pattern for mounting MD004.

This circuit pattern is 50Ω microstrip line with Epoxy-Glass printed circuit board.

- It's desirable that distance of each RF port is as far as possible.
- Each GND terminal ①, ③, ⑥ should be soldered at both side S, C ground plane.
- Each x point should be treated through hole or jumper.

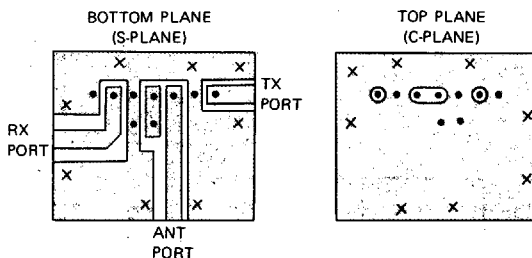

Fig A