

Features

- **Low-Voltage and Standard-Voltage Operation**
 - 5.0 ($V_{CC} = 4.5V$ to $5.5V$)
 - 2.7 ($V_{CC} = 2.7V$ to $5.5V$)
 - 2.5 ($V_{CC} = 2.5V$ to $5.5V$)
 - 1.8 ($V_{CC} = 1.8V$ to $5.5V$)
- **Low-Power Devices ($I_{SB} = 2 \mu A$ @ $5.5V$) Available**
- **Internally Organized 4096 x 8, 8192 x 8**
- **2-Wire Serial Interface**
- **Schmitt Trigger, Filtered Inputs for Noise Suppression**
- **Bidirectional Data Transfer Protocol**
- **100 kHz (1.8V, 2.5V, 2.7V) and 400 kHz (5V) Compatibility**
- **Write Protect Pin for Hardware Data Protection**
- **32-Byte Page Write Mode (Partial Page Writes Allowed)**
- **Self-Timed Write Cycle (10 ms max)**
- **High Reliability**
 - **Endurance: 1 Million Write Cycles**
 - **Data Retention: 100 Years**
 - **ESD Protection: >3,000V**
- **Automotive Grade and Extended Temperature Devices Available**
- **8-Pin JEDEC PDIP, 8-Pin and 14-Pin JEDEC SOIC, 8-Pin EIAJ SOIC, and 8-pin TSSOP Packages**

Description

The AT24C32/64 provides 32,768/65,536 bits of serial electrically erasable and programmable read only memory (EEPROM) organized as 4096/8192 words of 8 bits each. The device's cascadable feature allows up to 8 devices to share a common 2-wire bus. The device is optimized for use in many industrial and commercial applications where low power and low voltage operation are essential. The AT24C32/64 is available in space saving 8-pin JEDEC PDIP, 8-pin and 14-pin JEDEC SOIC, 8-pin EIAJ SOIC, and 8-pin TSSOP packages and is accessed via a 2-wire serial interface. In addition, the entire family is available in 5.0V (4.5V to 5.5V), 2.7V (2.7V to 5.5V), 2.5V (2.5V to 5.5V) and 1.8V (1.8V to 5.5V) versions.

Pin Configurations

Pin Name	Function
A0 to A2	Address Inputs
SDA	Serial Data
SCL	Serial Clock Input
WP	Write Protect

14-Pin SOIC

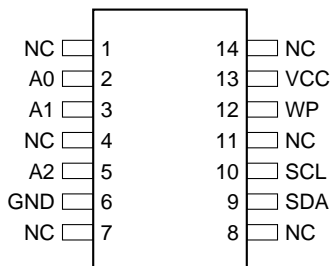

8-Pin PDIP

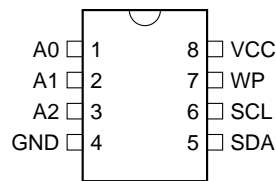

8-Pin TSSOP

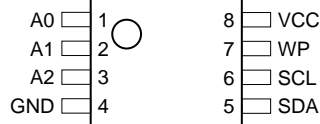

8-Pin SOIC

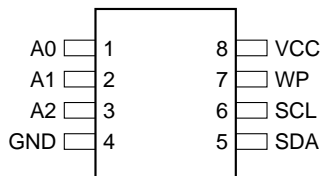

2-Wire Serial EEPROM

32K (4096 x 8)

64K (8192 x 8)

AT24C32

AT24C64



Pin Capacitance⁽¹⁾

Applicable over recommended operating range from $T_A = 25^\circ\text{C}$, $f = 1.0\text{ MHz}$, $V_{CC} = +1.8\text{V}$.

Symbol	Test Condition	Max	Units	Conditions
$C_{I/O}$	Input/Output Capacitance (SDA)	8	pF	$V_{I/O} = 0\text{V}$
C_{IN}	Input Capacitance ($A_0, A_1, A_2, \text{SCL}$)	6	pF	$V_{IN} = 0\text{V}$

Note: 1. This parameter is characterized and is not 100% tested.

DC Characteristics

Applicable over recommended operating range from: $T_{AI} = -40^\circ\text{C}$ to $+85^\circ\text{C}$, $V_{CC} = +1.8\text{V}$ to $+5.5\text{V}$, $T_{AC} = 0^\circ\text{C}$ to $+70^\circ\text{C}$, $V_{CC} = +1.8\text{V}$ to $+5.5\text{V}$ (unless otherwise noted).

Symbol	Parameter	Test Condition	Min	Typ	Max	Units
V_{CC1}	Supply Voltage		1.8		5.5	V
V_{CC2}	Supply Voltage		2.5		5.5	V
V_{CC3}	Supply Voltage		2.7		5.5	V
V_{CC4}	Supply Voltage		4.5		5.5	V
I_{CC1}	Supply Current $V_{CC} = 5.0\text{V}$	READ at 100 kHz		0.4	1.0	mA
I_{CC2}	Supply Current $V_{CC} = 5.0\text{V}$	WRITE at 100 kHz		2.0	3.0	mA
I_{SB1}	Standby Current (1.8V option)	$V_{CC} = 1.8\text{V}$	$V_{IN} = V_{CC}$ or V_{SS}		0.1	μA
		$V_{CC} = 5.5\text{V}$			2.0	
I_{SB2}	Standby Current (2.5V option)	$V_{CC} = 2.5\text{V}$	$V_{IN} = V_{CC}$ or V_{SS}		0.5	μA
		$V_{CC} = 5.5\text{V}$			2.0	
I_{SB3}	Standby Current (2.7V option)	$V_{CC} = 2.7\text{V}$	$V_{IN} = V_{CC}$ or V_{SS}		0.5	μA
		$V_{CC} = 5.5\text{V}$			2.0	
I_{SB4}	Standby Current (5V option)	$V_{CC} = 4.5 - 5.5\text{V}$	$V_{IN} = V_{CC}$ or V_{SS}	20	35	μA
I_{LI}	Input Leakage Current	$V_{IN} = V_{CC}$ or V_{SS}		0.10	3.0	μA
I_{LO}	Output Leakage Current	$V_{OUT} = V_{CC}$ or V_{SS}		0.05	3.0	μA
V_{IL}	Input Low Level ⁽¹⁾		-0.6		$V_{CC} \times 0.3$	V
V_{IH}	Input High Level ⁽¹⁾		$V_{CC} \times 0.7$		$V_{CC} + 0.5$	V
V_{OL2}	Output Low Level $V_{CC} = 3.0\text{V}$	$I_{OL} = 2.1\text{ mA}$			0.4	V
V_{OL1}	Output Low Level $V_{CC} = 1.8\text{V}$	$I_{OL} = 0.15\text{ mA}$			0.2	V

Notes: 1. V_{IL} min and V_{IH} max are reference only and are not tested.

AC Characteristics

Applicable over recommended operating range from $T_A = -40^{\circ}\text{C}$ to $+85^{\circ}\text{C}$, $V_{CC} = +1.8\text{V}$ to $+5.5\text{V}$, $CL = 1$ TTL Gate and 100 pF (unless otherwise noted).

Symbol	Parameter	1.8-volt		2.7-, 2.5-volt		5.0-volt		Units
		Min	Max	Min	Max	Min	Max	
f_{SCL}	Clock Frequency, SCL		100		100		400	kHz
t_{LOW}	Clock Pulse Width Low	4.7		4.7		1.2		μs
t_{HIGH}	Clock Pulse Width High	4.0		4.0		0.6		μs
t_I	Noise Suppression Time ⁽¹⁾		100		100		50	ns
t_{AA}	Clock Low to Data Out Valid	0.1	4.5	0.1	4.5	0.1	0.9	μs
t_{BUF}	Time the bus must be free before a new transmission can start ⁽¹⁾	4.7		4.7		1.2		μs
$t_{HD,STA}$	Start Hold Time	4.0		4.0		0.6		μs
$t_{SU,STA}$	Start Set-up Time	4.7		4.7		0.6		μs
$t_{HD,DAT}$	Data In Hold Time	0		0		0		μs
$t_{SU,DAT}$	Data In Set-up Time	200		200		100		ns
t_R	Inputs Rise Time ⁽¹⁾		1.0		1.0		0.3	μs
t_F	Inputs Fall Time ⁽¹⁾		300		300		300	ns
$t_{SU,STO}$	Stop Set-up Time	4.7		4.7		0.6		μs
t_{DH}	Data Out Hold Time	100		100		50		ns
t_{WR}	Write Cycle Time		20		10		10	ms
Endurance ⁽¹⁾	5.0V, 25°C, Page Mode	1M		1M		1M		Write Cycles

Note: 1. This parameter is characterized and is not 100% tested.

Device Operation

CLOCK and DATA TRANSITIONS: The SDA pin is normally pulled high with an external device. Data on the SDA pin may change only during SCL low time periods (refer to Data Validity timing diagram). Data changes during SCL high periods will indicate a start or stop condition as defined below.

START CONDITION: A high-to-low transition of SDA with SCL high is a start condition which must precede any other command (refer to Start and Stop Definition timing diagram).

STOP CONDITION: A low-to-high transition of SDA with SCL high is a stop condition. After a read sequence, the stop command will place the EEPROM in a standby power mode (refer to Start and Stop Definition timing diagram).

ACKNOWLEDGE: All addresses and data words are serially transmitted to and from the EEPROM in 8-bit words. The EEPROM sends a zero during the ninth clock cycle to acknowledge that it has received each word.

STANDBY MODE: The AT24C32/64 features a low power standby mode which is enabled: a) upon power-up and b) after the receipt of the STOP bit and the completion of any internal operations.

MEMORY RESET: After an interruption in protocol, power loss or system reset, any 2-wire part can be reset by following these steps:

(a) Clock up to 9 cycles, (b) look for SDA high in each cycle while SCL is high and then (c) create a start condition as SDA is high.

Bus Timing
SCL: Serial Clock, SDA: Serial Data I/O

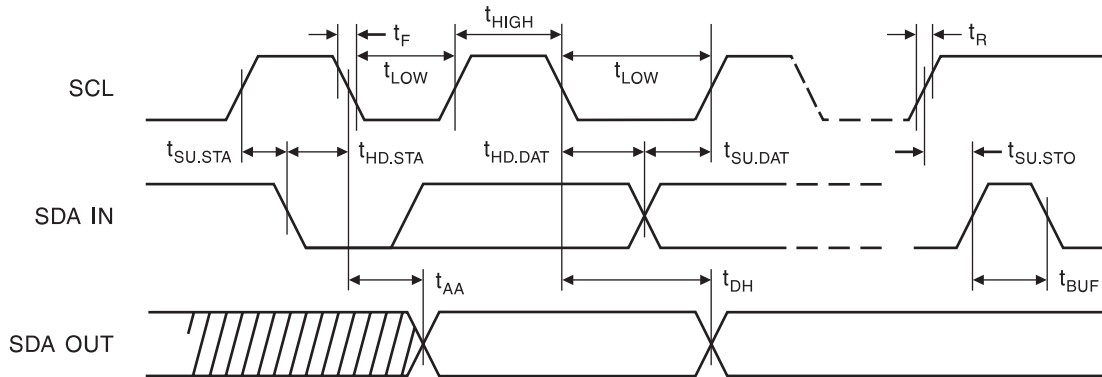

Write Cycle Timing
SCL: Serial Clock, SDA: Serial Data I/O

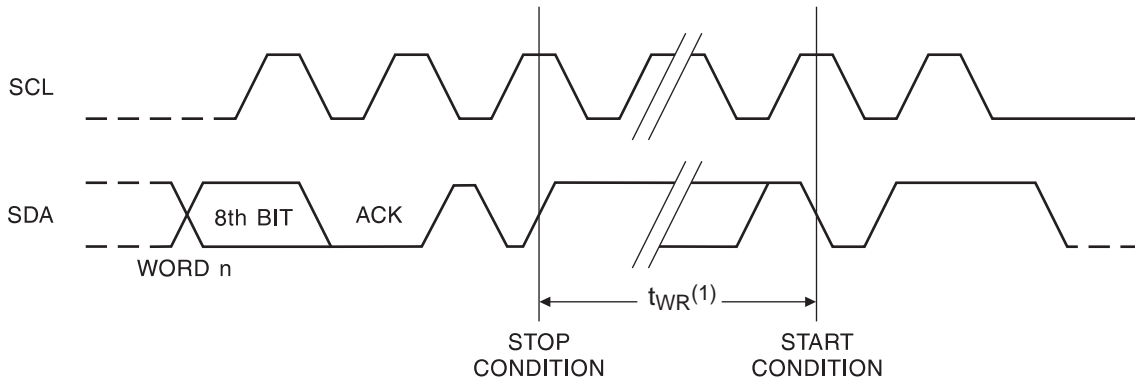

Note: 1. The write cycle time t_{WR} is the time from a valid stop condition of a write sequence to the end of the internal clear/write cycle.

Data Validity

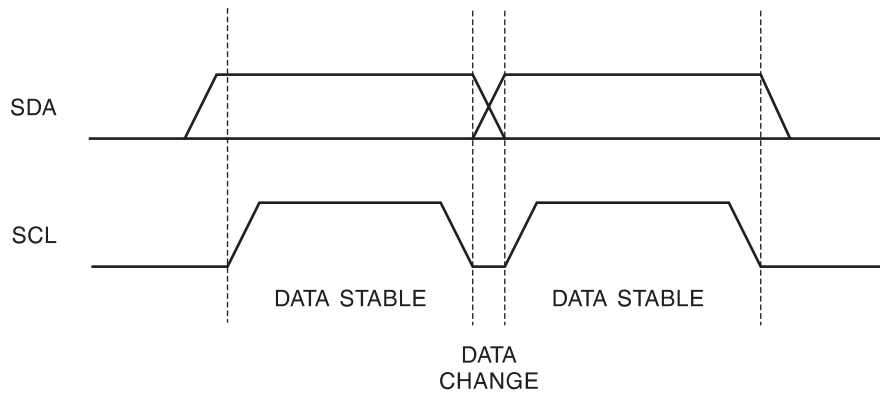

Start and Stop Definition

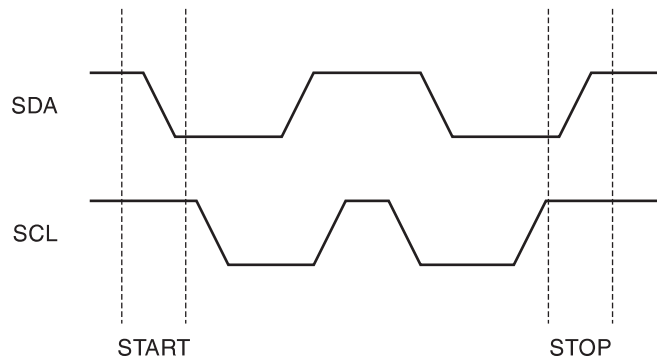

Output Acknowledge

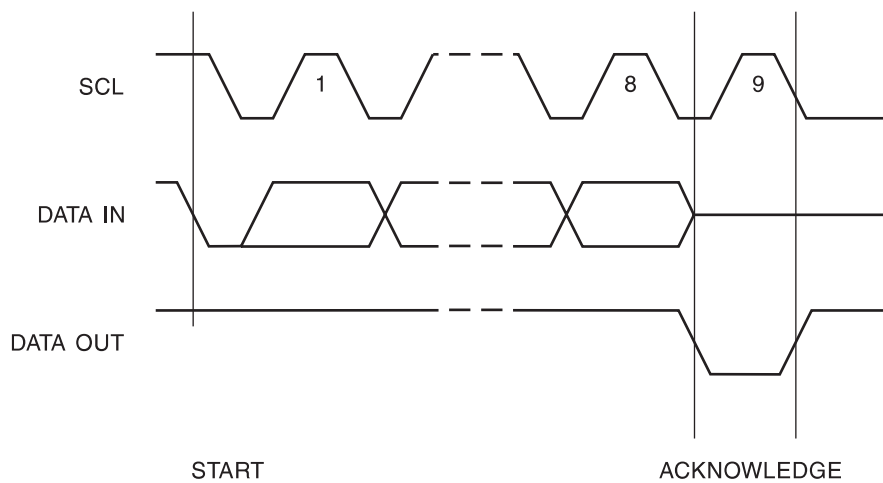

Device Addressing

The 32K/64K EEPROM requires an 8-bit device address word following a start condition to enable the chip for a read or write operation (refer to Figure 1). The device address word consists of a mandatory one, zero sequence for the first four most significant bits as shown. This is common to all 2-wire EEPROM devices.

The 32K/64K uses the three device address bits A2, A1, A0 to allow as many as eight devices on the same bus. These bits must compare to their corresponding hardwired input pins. The A2, A1, and A0 pins use an internal proprietary circuit that biases them to a logic low condition if the pins are allowed to float.

The eighth bit of the device address is the read/write operation select bit. A read operation is initiated if this bit is high and a write operation is initiated if this bit is low.

Upon a compare of the device address, the EEPROM will output a zero. If a compare is not made, the device will return to standby state.

NOISE PROTECTION: Special internal circuitry placed on the SDA and SCL pins prevent small noise spikes from activating the device. A low- V_{CC} detector (5-volt option) resets the device to prevent data corruption in a noisy environment.

DATA SECURITY: The AT24C32/64 has a hardware data protection scheme that allows the user to write protect the upper quadrant (8/16K bits) of memory when the WP pin is at V_{CC} .

Write Operations

BYTE WRITE: A write operation requires two 8-bit data word addresses following the device address word and acknowledgment. Upon receipt of this address, the EEPROM will again respond with a zero and then clock in the first 8-bit data word. Following receipt of the 8-bit data word, the EEPROM will output a zero and the addressing device, such as a microcontroller, must terminate the write sequence with a stop condition. At this time the EEPROM enters an internally-timed write cycle, t_{WR} , to the nonvolatile memory. All inputs are disabled during this write cycle and the EEPROM will not respond until the write is complete (refer to Figure 2).

PAGE WRITE: The 32K/64K EEPROM is capable of 32-byte page writes.

A page write is initiated the same way as a byte write, but the microcontroller does not send a stop condition after the first data word is clocked in. Instead, after the EEPROM acknowledges receipt of the first data word, the microcontroller can transmit up to 31 more data words. The EEPROM will respond with a zero after each data word received. The microcontroller must terminate the page write sequence with a stop condition (refer to Figure 3).

The data word address lower 5 bits are internally incremented following the receipt of each data word. The higher data word address bits are not incremented, retaining the memory page row location. When the word address, internally generated, reaches the page boundary, the following byte is placed at the beginning of the same page. If more than 32 data words are transmitted to the EEPROM, the data word address will “roll over” and previous data will be overwritten.

ACKNOWLEDGE POLLING: Once the internally-timed write cycle has started and the EEPROM inputs are disabled, acknowledge polling can be initiated. This involves sending a start condition followed by the device address word. The read/write bit is representative of the operation desired. Only if the internal write cycle has completed will the EEPROM respond with a zero, allowing the read or write sequence to continue.

Read Operations

Read operations are initiated the same way as write operations with the exception that the read/write select bit in the device address word is set to one. There are three read operations: current address read, random address read and sequential read.

CURRENT ADDRESS READ: The internal data word address counter maintains the last address accessed during the last read or write operation, incremented by one. This address stays valid between operations as long as the chip power is maintained. The address “roll over” during read is from the last byte of the last memory page, to the first byte of the first page. The address “roll over” during write is from the last byte of the current page to the first byte of the same page.

Once the device address with the read/write select bit set to one is clocked in and acknowledged by the EEPROM, the current address data word is serially clocked out. The microcontroller does not respond with an input zero but does generate a following stop condition (refer to Figure 4).

RANDOM READ: A random read requires a “dummy” byte write sequence to load in the data word address. Once the device address word and data word address are clocked in and acknowledged by the EEPROM, the microcontroller must generate another start condition. The microcontroller now initiates a current address read by sending a device address with the read/write select bit high. The EEPROM acknowledges the device address and serially clocks out the data word. The microcontroller does not respond with a zero but does generate a following stop condition (refer to Figure 5).

SEQUENTIAL READ: Sequential reads are initiated by either a current address read or a random address read. After the microcontroller receives a data word, it responds with an acknowledge. As long as the EEPROM receives an

acknowledge, it will continue to increment the data word address and serially clock out sequential data words. When the memory address limit is reached, the data word address will “roll over” and the sequential read will con-

tinue. The sequential read operation is terminated when the microcontroller does not respond with a zero but does generate a following stop condition (refer to Figure 6).

Figure 1. Device Address

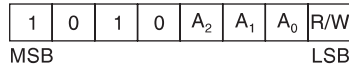

Figure 2. Byte Write

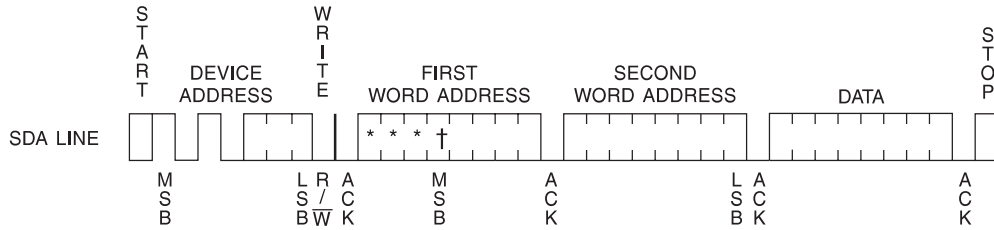
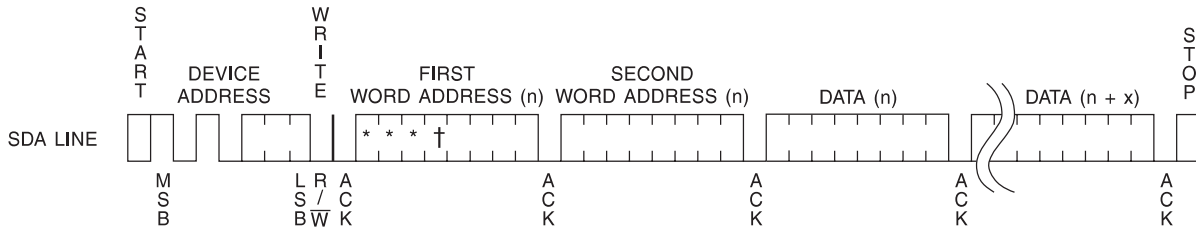

Figure 3. Page Write



Notes: 1. * = DON'T CARE bits

2. † = DON'T CARE bits for the 32K

Figure 4. Current Address Read

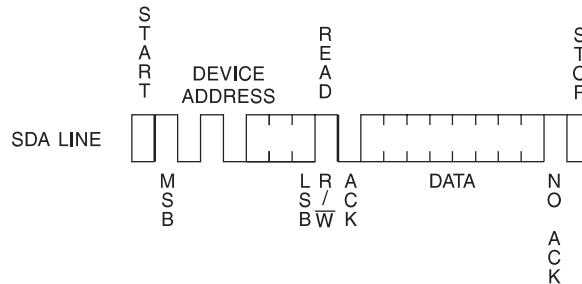
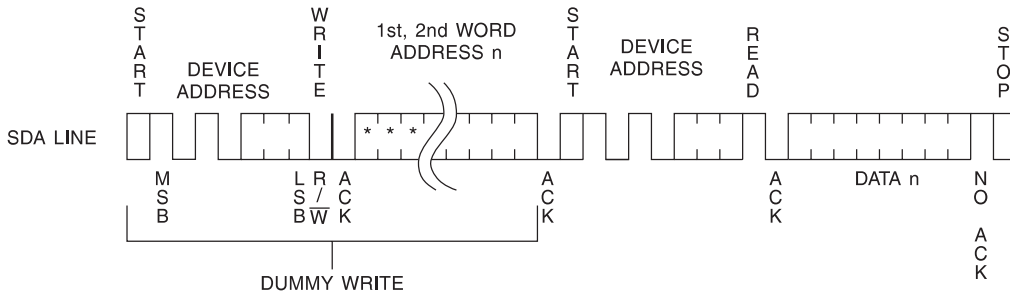
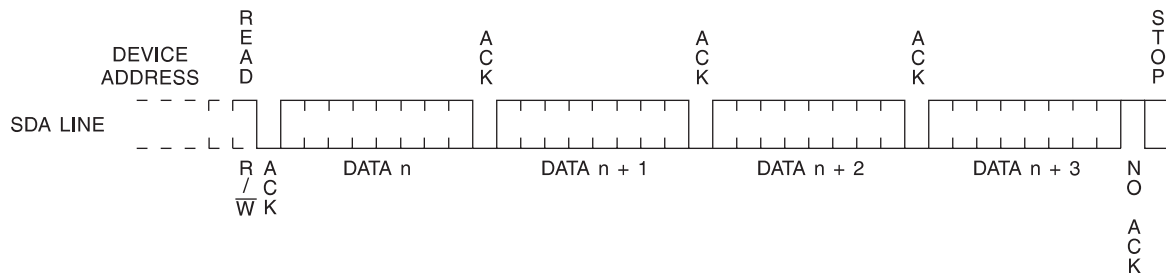

Figure 5. Random Read



Note: 1. * = DON'T CARE bits

Figure 6. Sequential Read





AT24C32 Ordering Information

t_{WR} (max) (ms)	I_{CC} (max) (μA)	I_{SB} (max) (μA)	f_{MAX} (kHz)	Ordering Code	Package	Operation Range
10	3000	35	400	AT24C32-10PC	8P3	Commercial (0°C to 70°C)
				AT24C32N-10SC	8S1	
AT24C32W-10SC	8S2					
AT24C32-10TC	8T					
AT24C32-10SC	14S					
10	3000	35	400	AT24C32-10PI	8P3	Industrial (-40°C to 85°C)
				AT24C32N-10SI	8S1	
AT24C32W-10SI	8S2					
AT24C32-10TI	8T					
AT24C32-10SI	14S					
10	1500	0.5	100	AT24C32-10PC-2.7	8P3	Commercial (0°C to 70°C)
				AT24C32N-10SC-2.7	8S1	
AT24C32W-10SC-2.7	8S2					
AT24C32-10TC-2.7	8T					
AT24C32-10SC-2.7	14S					
10	1500	0.5	100	AT24C32-10PI-2.7	8P3	Industrial (-40°C to 85°C)
				AT24C32N-10SI-2.7	8S1	
AT24C32W-10SI-2.7	8S2					
AT24C32-10TI-2.7	8T					
AT24C32-10SI-2.7	14S					

Package Type	
8P3	8-Lead, 0.300" Wide, Plastic Dual Inline Package (PDIP)
8S1	8-Lead, 0.150" Wide, Plastic Gull Wing Small Outline (JEDEC SOIC)
8S2	8-Lead, 0.200" Wide, Plastic Gull Wing Small Outline (EIAJ SOIC)
8T	8-Lead, 0.170" Wide, Plastic Gull Wing Small Outline (TSSOP)
14S	14-Lead, 0.150" Wide, Plastic Gull Wing Small Outline (SOIC)
Options	
Blank	Standard Operation (4.5V to 5.5V)
-2.7	Low Voltage (2.7V to 5.5V)
-2.5	Low Voltage (2.5V to 5.5V)
-1.8	Low Voltage (1.8V to 5.5V)

AT24C32 Ordering Information (Continued)

t_{WR} (max) (ms)	I_{CC} (max) (μ A)	I_{SB} (max) (μ A)	f_{MAX} (kHz)	Ordering Code	Package	Operation Range
10	1000	0.5	100	AT24C32-10PC-2.5 AT24C32N-10SC-2.5 AT24C32W-10SC-2.5 AT24C32-10TC-2.5 AT24C32-10SC-2.5	8P3 8S1 8S2 8T 14S	Commercial (0°C to 70°C)
	1000	0.5	100	AT24C32-10PI-2.5 AT24C32N-10SI-2.5 AT24C32W-10SI-2.5 AT24C32-10TI-2.5 AT24C32-10SI-2.5	8P3 8S1 8S2 8T 14S	Industrial (-40°C to 85°C)
10	800	0.1	100	AT24C32-10PC-1.8 AT24C32N-10SC-1.8 AT24C32W-10SC-1.8 AT24C32-10TC-1.8 AT24C32-10SC-1.8	8P3 8S1 8S2 8T 14S	Commercial (0°C to 70°C)
	800	0.1	100	AT24C32-10PI-1.8 AT24C32N-10SI-1.8 AT24C32W-10SI-1.8 AT24C32-10TI-1.8 AT24C32-10SI-1.8	8P3 8S1 8S2 8T 14S	Industrial (-40°C to 85°C)

Package Type	
8P3	8-Lead, 0.300" Wide, Plastic Dual Inline Package (PDIP)
8S1	8-Lead, 0.150" Wide, Plastic Gull Wing Small Outline (JEDEC SOIC)
8S2	8-Lead, 0.200" Wide, Plastic Gull Wing Small Outline (EIAJ SOIC)
8T	8-Lead, 0.170" Wide, Plastic Gull Wing Small Outline (TSSOP)
14S	14-Lead, 0.150" Wide, Plastic Gull Wing Small Outline (SOIC)
Options	
Blank	Standard Operation (4.5V to 5.5V)
-2.7	Low Voltage (2.7V to 5.5V)
-2.5	Low Voltage (2.5V to 5.5V)
-1.8	Low Voltage (1.8V to 5.5V)



AT24C64 Ordering Information

t_{WR} (max) (ms)	I_{CC} (max) (μA)	I_{SB} (max) (μA)	f_{MAX} (kHz)	Ordering Code	Package	Operation Range
10	3000	35	400	AT24C64-10PC	8P3	Commercial (0°C to 70°C)
				AT24C64N-10SC	8S1	
AT24C64W-10SC	8S2					
AT24C64-10TC	8T					
AT24C64-10SC	14S					
10	3000	35	400	AT24C64-10PI	8P3	Industrial (-40°C to 85°C)
				AT24C64N-10SI	8S1	
AT24C64W-10SI	8S2					
AT24C64-10TI	8T					
AT24C64-10SI	14S					
10	1500	0.5	100	AT24C64-10PC-2.7	8P3	Commercial (0°C to 70°C)
				AT24C64N-10SC-2.7	8S1	
AT24C64W-10SC-2.7	8S2					
AT24C64-10TC-2.7	8T					
AT24C64-10SC-2.7	14S					
10	1500	0.5	100	AT24C64-10PI-2.7	8P3	Industrial (-40°C to 85°C)
				AT24C64N-10SI-2.7	8S1	
AT24C64W-10SI-2.7	8S2					
AT24C64-10TI-2.7	8T					
AT24C64-10SI-2.7	14S					

Package Type	
8P3	8-Lead, 0.300" Wide, Plastic Dual Inline Package (PDIP)
8S1	8-Lead, 0.150" Wide, Plastic Gull Wing Small Outline (JEDEC SOIC)
8S2	8-Lead, 0.200" Wide, Plastic Gull Wing Small Outline (EIAJ SOIC)
8T	8-Lead, 0.170" Wide, Plastic Gull Wing Small Outline (TSSOP)
14S	14-Lead, 0.150" Wide, Plastic Gull Wing Small Outline (SOIC)
Options	
Blank	Standard Operation (4.5V to 5.5V)
-2.7	Low Voltage (2.7V to 5.5V)
-2.5	Low Voltage (2.5V to 5.5V)
-1.8	Low Voltage (1.8V to 5.5V)

AT24C64 Ordering Information (Continued)

t_{WR} (max) (ms)	I_{CC} (max) (μA)	I_{SB} (max) (μA)	f_{MAX} (kHz)	Ordering Code	Package	Operation Range
10	1000	0.5	100	AT24C64-10PC-2.5 AT24C64N-10SC-2.5 AT24C64W-10SC-2.5 AT24C64-10TC-2.5 AT24C64-10SC-2.5	8P3 8S1 8S2 8T 14S	Commercial (0°C to 70°C)
	1000	0.5	100	AT24C64-10PI-2.5 AT24C64N-10SI-2.5 AT24C64W-10SI-2.5 AT24C64-10TI-2.5 AT24C64-10SI-2.5	8P3 8S1 8S2 8T 14S	Industrial (-40°C to 85°C)
10	800	0.1	100	AT24C64-10PC-1.8 AT24C64N-10SC-1.8 AT24C64W-10SC-1.8 AT24C64-10TC-1.8 AT24C64-10SC-1.8	8P3 8S1 8S2 8T 14S	Commercial (0°C to 70°C)
	800	0.1	100	AT24C64-10PI-1.8 AT24C64N-10SI-1.8 AT24C64W-10SI-1.8 AT24C64-10TI-1.8 AT24C64-10SI-1.8	8P3 8S1 8S2 8T 14S	Industrial (-40°C to 85°C)

Package Type	
8P3	8-Lead, 0.300" Wide, Plastic Dual Inline Package (PDIP)
8S1	8-Lead, 0.150" Wide, Plastic Gull Wing Small Outline (JEDEC SOIC)
8S2	8-Lead, 0.200" Wide, Plastic Gull Wing Small Outline (EIAJ SOIC)
8T	8-Lead, 0.170" Wide, Plastic Gull Wing Small Outline (TSSOP)
14S	14-Lead, 0.150" Wide, Plastic Gull Wing Small Outline (SOIC)
Options	
Blank	Standard Operation (4.5V to 5.5V)
-2.7	Low Voltage (2.7V to 5.5V)
-2.5	Low Voltage (2.5V to 5.5V)
-1.8	Low Voltage (1.8V to 5.5V)

Packaging Information

8P3, 8-Lead, 0.300" Wide, Plastic Dual Inline Package (PDIP)

Dimensions in Inches and (Millimeters)
JEDEC STANDARD MS-001 BA

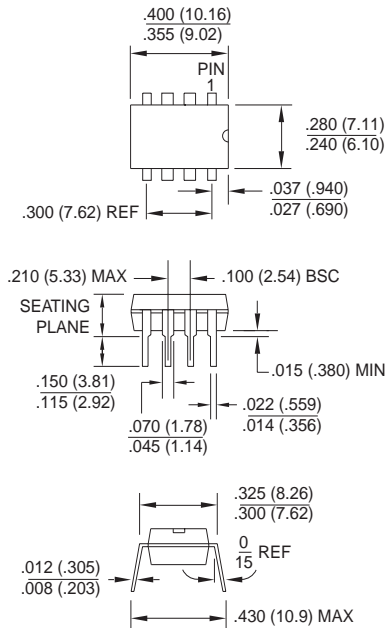

8S1, 8-Lead, 0.150" Wide, Plastic Gull Wing Small Outline (JEDEC SOIC)

Dimensions in Inches and (Millimeters)

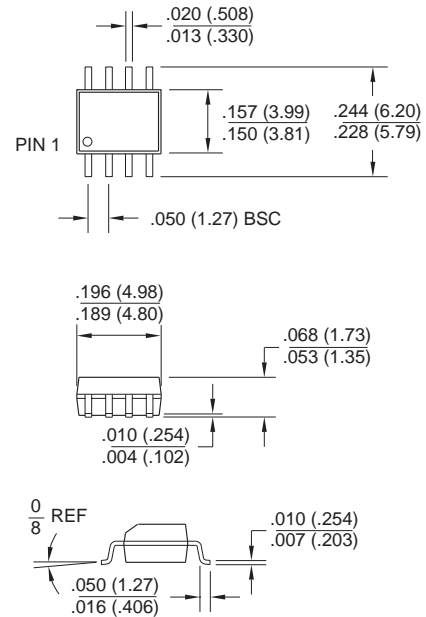

8S2, 8-Lead, 0.200" Wide, Plastic Gull Wing Small Outline (EIAJ SOIC)

Dimensions in Inches and (Millimeters)

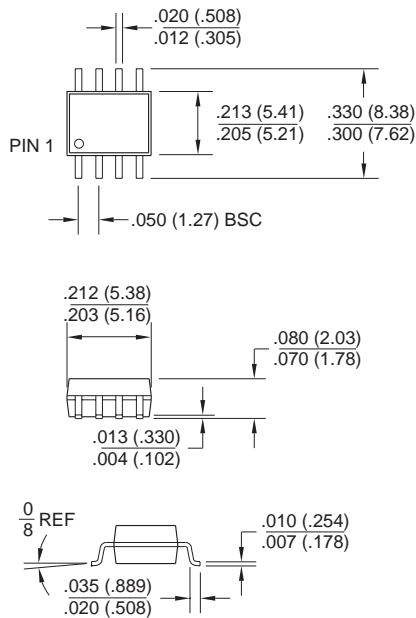

8T, 8-Lead, Plastic Thin Small Outline Package (TSSOP)

Dimensions in Millimeters and (Inches)*

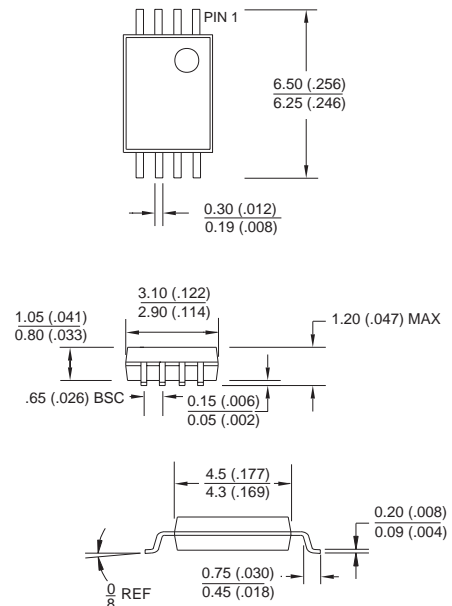

*Controlling dimension: millimeters

Packaging Information

14S, 14-Lead, 0.150" Wide, Plastic Gull Wing Small Outline (SOIC)
 Dimensions in Inches and (Millimeters)

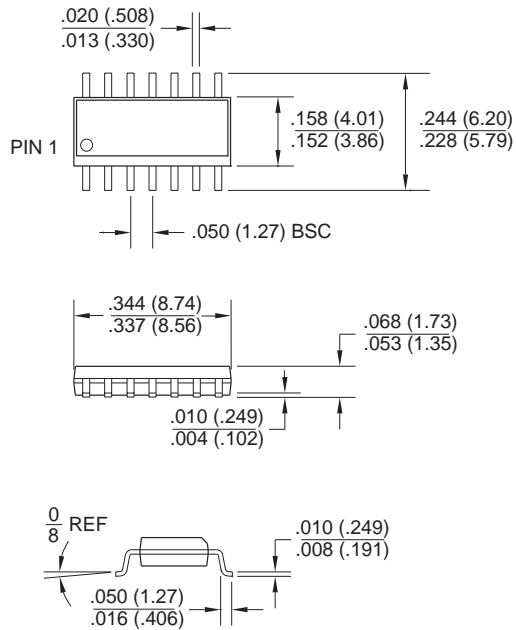

This datasheet has been downloaded from:

www.DatasheetCatalog.com

Datasheets for electronic components.