

MC74HC164A

8-Bit Serial-Input/Parallel-Output Shift Register

High-Performance Silicon-Gate CMOS

The MC74HC164A is identical in pinout to the LS164. The device inputs are compatible with standard CMOS outputs; with pullup resistors, they are compatible with LSTTL outputs.

The MC74HC164A is an 8-bit, serial-input to parallel-output shift register. Two serial data inputs, A1 and A2, are provided so that one input may be used as a data enable. Data is entered on each rising edge of the clock. The active-low asynchronous Reset overrides the Clock and Serial Data inputs.

Features

- Output Drive Capability: 10 LSTTL Loads
- Outputs Directly Interface to CMOS, NMOS, and TTL
- Operating Voltage Range: 2.0 V to 6.0 V
- Low Input Current: 1 μ A
- High Noise Immunity Characteristic of CMOS Devices
- In Compliance with the JEDEC Standard No. 7A Requirements
- Chip Complexity: 244 FETs or 61 Equivalent Gates
- Pb-Free Packages are Available



ON Semiconductor®

<http://onsemi.com>

MARKING DIAGRAMS

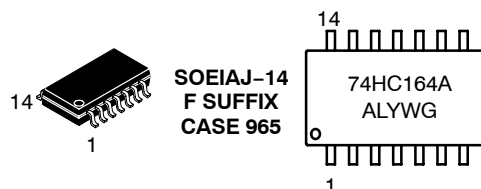
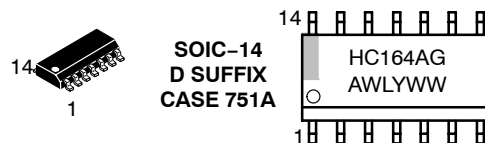
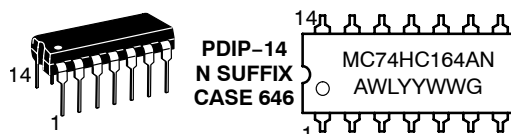

A = Assembly Location
L, WL = Wafer Lot
Y, YY = Year
W, WW = Work Week
G or ■ = Pb-Free Package

(Note: Microdot may be in either location)

ORDERING INFORMATION

See detailed ordering and shipping information in the package dimensions section on page 2 of this data sheet.

MC74HC164A

PIN ASSIGNMENT

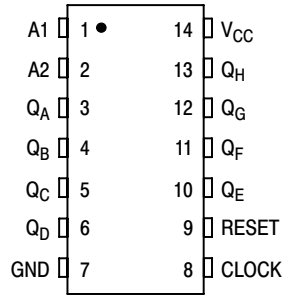

LOGIC DIAGRAM

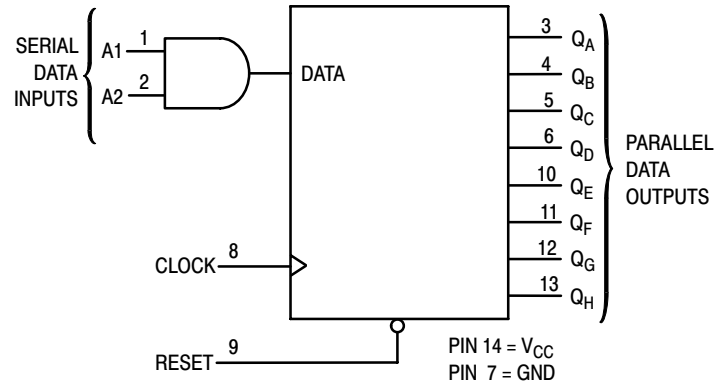

FUNCTION TABLE

Inputs				Outputs			
Reset	Clock	A1	A2	QA	QB	...	QH
L	X	X	X	L	L	...	L
H		X	X	No Change			
H		H	D	D	QA _n	...	QG _n
H		D	H	D	QA _n	...	QG _n

D = data input

QA_n - QG_n = data shifted from the preceding stage on a rising edge at the clock input.

ORDERING INFORMATION

Device	Package	Shipping†
MC74HC164AN	PDIP-14	25 Units / Rail
MC74HC164ANG	PDIP-14 (Pb-Free)	
MC74HC164AD	SOIC-14	55 Units / Rail
MC74HC164ADG	SOIC-14 (Pb-Free)	
MC74HC164ADR2	SOIC-14	2500 / Tape & Reel
MC74HC164ADR2G	SOIC-14 (Pb-Free)	
MC74HC164ADTR2	TSSOP-14*	
MC74HC164ADTR2G	TSSOP-14*	
MC74HC164AFEL	SOEIAJ-14	2000 / Tape & Reel
MC74HC164AFELG	SOEIAJ-14 (Pb-Free)	

†For information on tape and reel specifications, including part orientation and tape sizes, please refer to our Tape and Reel Packaging Specifications Brochure, BRD8011/D.

*This package is inherently Pb-Free.

MC74HC164A

MAXIMUM RATINGS

Symbol	Parameter	Value	Unit
V_{CC}	DC Supply Voltage (Referenced to GND)	- 0.5 to + 7.0	V
V_{in}	DC Input Voltage (Referenced to GND)	- 0.5 to $V_{CC} + 0.5$	V
V_{out}	DC Output Voltage (Referenced to GND)	- 0.5 to $V_{CC} + 0.5$	V
I_{in}	DC Input Current, per Pin	± 20	mA
I_{out}	DC Output Current, per Pin	± 25	mA
I_{CC}	DC Supply Current, V_{CC} and GND Pins	± 50	mA
P_D	Power Dissipation in Still Air, Plastic DIP† SOIC Package† TSSOP Package†	750 500 450	mW
T_{stg}	Storage Temperature	- 65 to + 150	°C
T_L	Lead Temperature, 1 mm from Case for 10 Seconds (Plastic DIP, SOIC or TSSOP Package)	260	°C

This device contains protection circuitry to guard against damage due to high static voltages or electric fields. However, precautions must be taken to avoid applications of any voltage higher than maximum rated voltages to this high-impedance circuit. For proper operation, V_{in} and V_{out} should be constrained to the range $GND \leq (V_{in} \text{ or } V_{out}) \leq V_{CC}$. Unused inputs must always be tied to an appropriate logic voltage level (e.g., either GND or V_{CC}). Unused outputs must be left open.

Stresses exceeding Maximum Ratings may damage the device. Maximum Ratings are stress ratings only. Functional operation above the Recommended Operating Conditions is not implied. Extended exposure to stresses above the Recommended Operating Conditions may affect device reliability.

†Derating — Plastic DIP: - 10 mW/°C from 65° to 125°C
SOIC Package: - 7 mW/°C from 65° to 125°C
TSSOP Package: - 6.1 mW/°C from 65° to 125°C

For high frequency or heavy load considerations, see Chapter 2 of the ON Semiconductor High-Speed CMOS Data Book (DL129/D).

RECOMMENDED OPERATING CONDITIONS

Symbol	Parameter	Min	Max	Unit
V_{CC}	DC Supply Voltage (Referenced to GND)	2.0	6.0	V
V_{in}, V_{out}	DC Input Voltage, Output Voltage (Referenced to GND)	0	V_{CC}	V
T_A	Operating Temperature, All Package Types	- 55	+ 125	°C
t_r, t_f	Input Rise and Fall Time (Figure 1)	$V_{CC} = 2.0 \text{ V}$ 0 $V_{CC} = 4.5 \text{ V}$ 0 $V_{CC} = 6.0 \text{ V}$ 0	1000 500 400	ns

DC ELECTRICAL CHARACTERISTICS (Voltages Referenced to GND)

Symbol	Parameter	Test Conditions	V_{CC} V	Guaranteed Limit			Unit		
				-55°C to 25°C	≤ 85°C	≤ 125°C			
V_{IH}	Minimum High-Level Input Voltage	$V_{out} = 0.1 \text{ V}$ or $V_{CC} - 0.1 \text{ V}$ $ I_{out} \leq 20 \mu\text{A}$	2.0	1.5	1.5	1.5	V		
			3.0	2.1	2.1	2.1			
			4.5	3.15	3.15	3.15			
			6.0	4.2	4.2	4.2			
V_{IL}	Maximum Low-Level Input Voltage	$V_{out} = 0.1 \text{ V}$ or $V_{CC} - 0.1 \text{ V}$ $ I_{out} \leq 20 \mu\text{A}$	2.0	0.5	0.5	0.5	V		
			3.0	0.9	0.9	0.9			
			4.5	1.35	1.35	1.35			
			6.0	1.8	1.8	1.8			
V_{OH}	Minimum High-Level Output Voltage	$V_{in} = V_{IH}$ or V_{IL} $ I_{out} \leq 20 \mu\text{A}$	2.0	1.9	1.9	1.9	V		
			4.5	4.4	4.4	4.4			
			6.0	5.9	5.9	5.9			
			$V_{in} = V_{IH}$ or V_{IL}	$ I_{out} \leq 2.4 \text{ mA}$	3.0	2.48		2.34	2.20
			$ I_{out} \leq 4.0 \text{ mA}$	4.5	3.98	3.84		3.70	
			$ I_{out} \leq 5.2 \text{ mA}$	6.0	5.48	5.34		5.20	

MC74HC164A

DC ELECTRICAL CHARACTERISTICS (Voltages Referenced to GND)

Symbol	Parameter	Test Conditions	V _{CC} V	Guaranteed Limit			Unit
				-55°C to 25°C	≤ 85°C	≤ 125°C	
V _{OL}	Maximum Low-Level Output Voltage	V _{in} = V _{IH} or V _{IL} I _{out} ≤ 20 μA	2.0	0.1	0.1	0.1	V
			4.5	0.1	0.1	0.1	
			6.0	0.1	0.1	0.1	
		V _{in} = V _{IH} or V _{IL} I _{out} ≤ 2.4 mA I _{out} ≤ 4.0 mA I _{out} ≤ 5.2 mA	3.0	0.26	0.33	0.40	
			4.5	0.26	0.33	0.40	
			6.0	0.26	0.33	0.40	
I _{in}	Maximum Input Leakage Current	V _{in} = V _{CC} or GND	6.0	±0.1	±1.0	±1.0	μA
I _{CC}	Maximum Quiescent Supply Current (per Package)	V _{in} = V _{CC} or GND I _{out} = 0 μA	6.0	4	40	160	μA

NOTE: Information on typical parametric values can be found in Chapter 2 of the ON Semiconductor High-Speed CMOS Data Book (DL129/D).

AC ELECTRICAL CHARACTERISTICS (C_L = 50 pF, Input t_r = t_f = 6 ns)

Symbol	Parameter	V _{CC} V	Guaranteed Limit			Unit
			-55°C to 25°C	≤ 85°C	≤ 125°C	
f _{max}	Maximum Clock Frequency (50% Duty Cycle) (Figures 1 and 4)	2.0	10	10	10	MHz
		3.0	20	20	20	
		4.5	40	35	30	
		6.0	50	45	40	
t _{PLH} , t _{PHL}	Maximum Propagation Delay, Clock to Q (Figures 1 and 4)	2.0	160	200	250	ns
		3.0	100	150	200	
		4.5	32	40	48	
		6.0	27	34	42	
t _{PHL}	Maximum Propagation Delay, Reset to Q (Figures 2 and 4)	2.0	175	220	260	ns
		3.0	100	150	200	
		4.5	35	44	53	
		6.0	30	37	45	
t _{TLH} , t _{THL}	Maximum Output Transition Time, Any Output (Figures 1 and 4)	2.0	75	95	110	ns
		3.0	27	32	36	
		4.5	15	19	22	
		6.0	13	16	19	
C _{in}	Maximum Input Capacitance	—	10	10	10	pF

NOTES:

- For propagation delays with loads other than 50 pF, see Chapter 2 of the ON Semiconductor High-Speed CMOS Data Book (DL129/D).
- Information on typical parametric values can be found in Chapter 2 of the ON Semiconductor High-Speed CMOS Data Book (DL129/D).

C _{PD}	Power Dissipation Capacitance (Per Package)*	Typical @ 25°C, V _{CC} = 5.0 V	
		180	

* Used to determine the no-load dynamic power consumption: P_D = C_{PD} V_{CC}²f + I_{CC} V_{CC}. For load considerations, see Chapter 2 of the ON Semiconductor High-Speed CMOS Data Book (DL129/D).

MC74HC164A

TIMING REQUIREMENTS (Input $t_r = t_f = 6$ ns)

Symbol	Parameter	V _{CC} V	Guaranteed Limit			Unit
			-55°C to 25°C	≤ 85°C	≤ 125°C	
t _{su}	Minimum Setup Time, A1 or A2 to Clock (Figure 3)	2.0	25	35	40	ns
		3.0	15	20	25	
		4.5	7	8	9	
		6.0	5	6	6	
t _h	Minimum Hold Time, Clock to A1 or A2 (Figure 3)	2.0	3	3	3	ns
		3.0	3	3	3	
		4.5	3	3	3	
		6.0	3	3	3	
t _{rec}	Minimum Recovery Time, Reset Inactive to Clock (Figure 2)	2.0	3	3	3	ns
		3.0	3	3	3	
		4.5	3	3	3	
		6.0	3	3	3	
t _w	Minimum Pulse Width, Clock (Figure 1)	2.0	50	60	75	ns
		3.0	26	35	45	
		4.5	12	15	20	
		6.0	10	12	15	
t _w	Minimum Pulse Width, Reset (Figure 2)	2.0	50	60	75	ns
		3.0	26	35	45	
		4.5	12	15	20	
		6.0	10	12	15	
t _r , t _f	Maximum Input Rise and Fall Times (Figure 1)	2.0	1000	1000	1000	ns
		3.0	800	800	800	
		4.5	500	500	500	
		6.0	400	400	400	

NOTE: Information on typical parametric values can be found in Chapter 2 of the ON Semiconductor High-Speed CMOS Data Book (DL129/D).

MC74HC164A

PIN DESCRIPTIONS

INPUTS

A1, A2 (Pins 1, 2)

Serial Data Inputs. Data at these inputs determine the data to be entered into the first stage of the shift register. For a high level to be entered into the shift register, both A1 and A2 inputs must be high, thereby allowing one input to be used as a data–enable input. When only one serial input is used, the other must be connected to V_{CC} .

Clock (Pin 8)

Shift Register Clock. A positive–going transition on this pin shifts the data at each stage to the next stage. The shift

register is completely static, allowing clock rates down to DC in a continuous or intermittent mode.

OUTPUTS

$Q_A - Q_H$ (Pins 3, 4, 5, 6, 10, 11, 12, 13)

Parallel Shift Register Outputs. The shifted data is presented at these outputs in true, or noninverted, form.

CONTROL INPUT

Reset (Pin 9)

Active–Low, Asynchronous Reset Input. A low voltage applied to this input resets all internal flip–flops and sets Outputs $Q_A - Q_H$ to the low level state.

SWITCHING WAVEFORMS

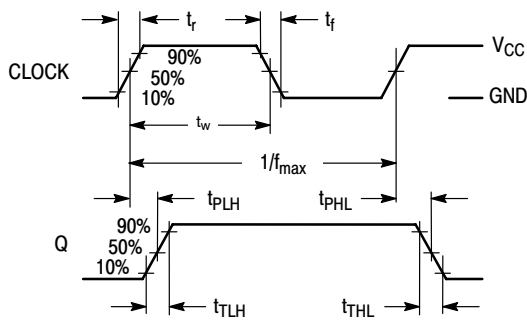

Figure 1.

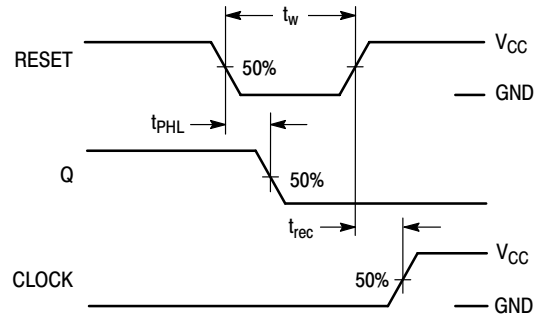

Figure 2.

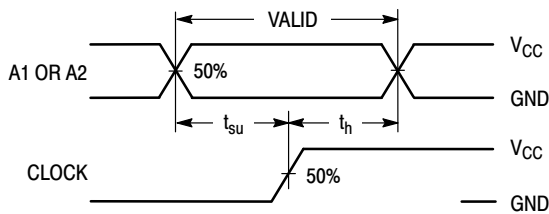
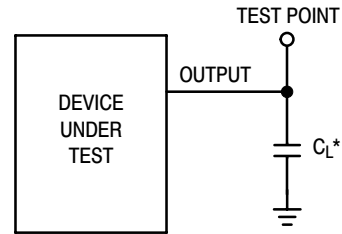

Figure 3.



*Includes all probe and jig capacitance

Figure 4. Test Circuit

MC74HC164A

EXPANDED LOGIC DIAGRAM

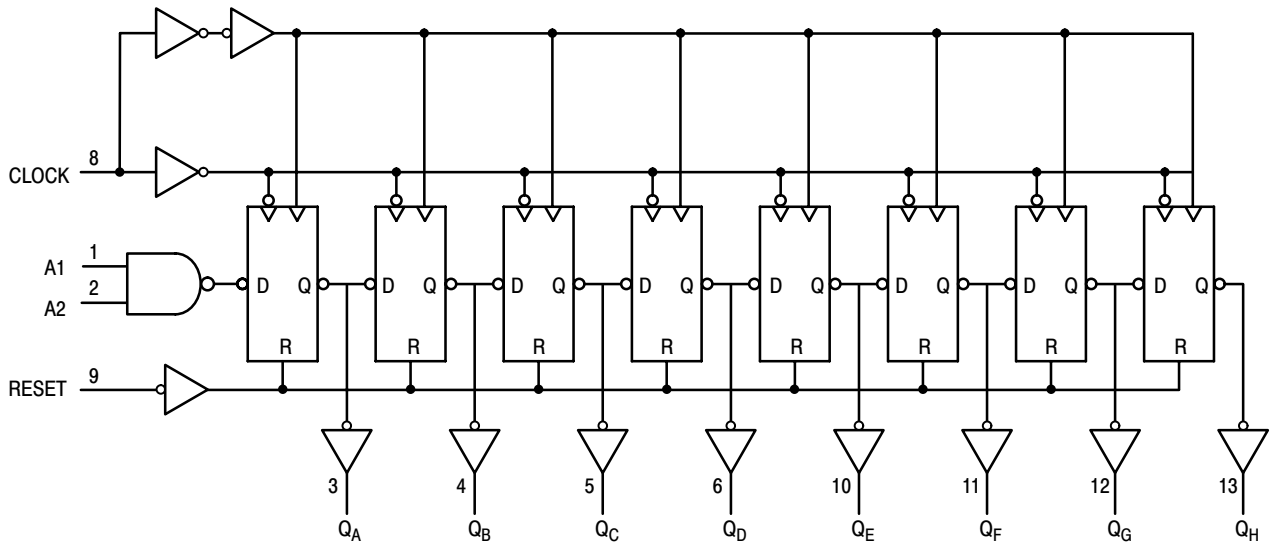

TIMING DIAGRAM

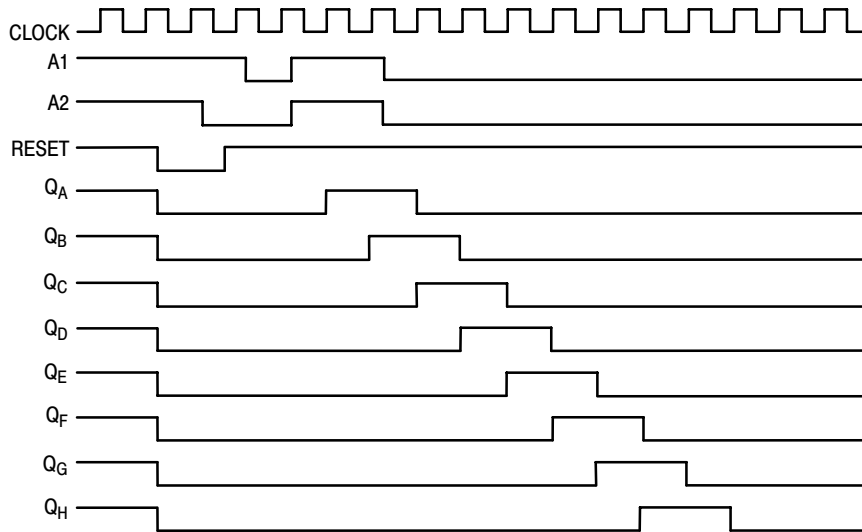

MC74HC164A

PACKAGE DIMENSIONS

PDIP-14
CASE 646-06
ISSUE P

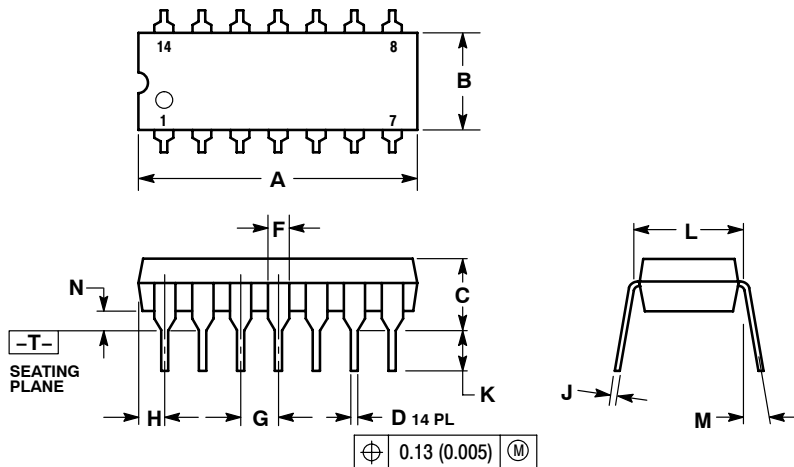

NOTES:

1. DIMENSIONING AND TOLERANCING PER ANSI Y14.5M, 1982.
2. CONTROLLING DIMENSION: INCH.
3. DIMENSION L TO CENTER OF LEADS WHEN FORMED PARALLEL.
4. DIMENSION B DOES NOT INCLUDE MOLD FLASH.
5. ROUNDED CORNERS OPTIONAL.

DIM	INCHES		MILLIMETERS	
	MIN	MAX	MIN	MAX
A	0.715	0.770	18.16	19.56
B	0.240	0.260	6.10	6.60
C	0.145	0.185	3.69	4.69
D	0.015	0.021	0.38	0.53
F	0.040	0.070	1.02	1.78
G	0.100 BSC		2.54 BSC	
H	0.052	0.095	1.32	2.41
J	0.008	0.015	0.20	0.38
K	0.115	0.135	2.92	3.43
L	0.290	0.310	7.37	7.87
M	---		10°	
N	0.015	0.039	0.38	1.01

MC74HC164A

PACKAGE DIMENSIONS

SOIC-14
CASE 751A-03
ISSUE H

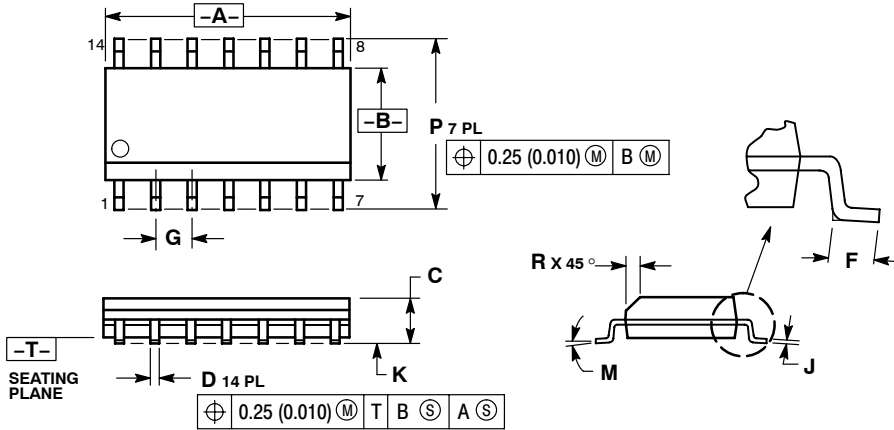

NOTES:

1. DIMENSIONING AND TOLERANCING PER ANSI Y14.5M, 1982.
2. CONTROLLING DIMENSION: MILLIMETER.
3. DIMENSIONS A AND B DO NOT INCLUDE MOLD PROTRUSION.
4. MAXIMUM MOLD PROTRUSION 0.15 (0.006) PER SIDE.
5. DIMENSION D DOES NOT INCLUDE DAMBAR PROTRUSION. ALLOWABLE DAMBAR PROTRUSION SHALL BE 0.127 (0.005) TOTAL IN EXCESS OF THE D DIMENSION AT MAXIMUM MATERIAL CONDITION.

DIM	MILLIMETERS		INCHES	
	MIN	MAX	MIN	MAX
A	8.55	8.75	0.337	0.344
B	3.80	4.00	0.150	0.157
C	1.35	1.75	0.054	0.068
D	0.35	0.49	0.014	0.019
F	0.40	1.25	0.016	0.049
G	1.27 BSC		0.050 BSC	
J	0.19	0.25	0.008	0.009
K	0.10	0.25	0.004	0.009
M	0°	7°	0°	7°
P	5.80	6.20	0.228	0.244
R	0.25	0.50	0.010	0.019

SOLDERING FOOTPRINT*

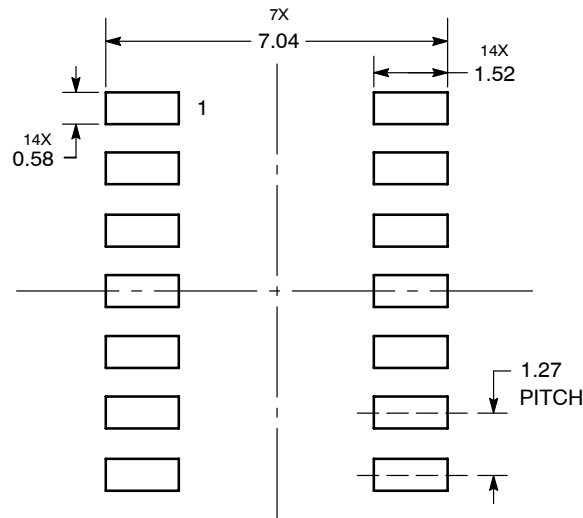

DIMENSIONS: MILLIMETERS

*For additional information on our Pb-Free strategy and soldering details, please download the ON Semiconductor Soldering and Mounting Techniques Reference Manual, SOLDERRM/D.

MC74HC164A

PACKAGE DIMENSIONS

SOEIAJ-14
CASE 965-01
ISSUE A

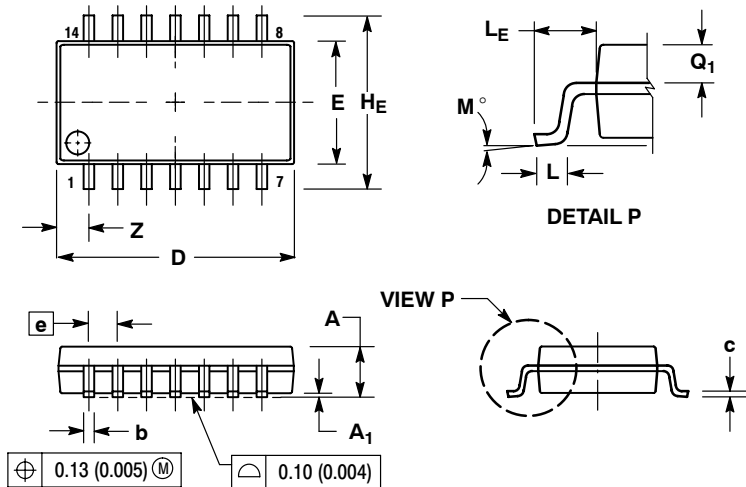

NOTES:

1. DIMENSIONING AND TOLERANCING PER ANSI Y14.5M, 1982.
2. CONTROLLING DIMENSION: MILLIMETER.
3. DIMENSIONS D AND E DO NOT INCLUDE MOLD FLASH OR PROTRUSIONS AND ARE MEASURED AT THE PARTING LINE. MOLD FLASH OR PROTRUSIONS SHALL NOT EXCEED 0.15 (0.006) PER SIDE.
4. TERMINAL NUMBERS ARE SHOWN FOR REFERENCE ONLY.
5. THE LEAD WIDTH DIMENSION (b) DOES NOT INCLUDE DAMBAR PROTRUSION. ALLOWABLE DAMBAR PROTRUSION SHALL BE 0.08 (0.003) TOTAL IN EXCESS OF THE LEAD WIDTH DIMENSION AT MAXIMUM MATERIAL CONDITION. DAMBAR CANNOT BE LOCATED ON THE LOWER RADIUS OR THE FOOT. MINIMUM SPACE BETWEEN PROTRUSIONS AND ADJACENT LEAD TO BE 0.46 (0.018).

DIM	MILLIMETERS		INCHES	
	MIN	MAX	MIN	MAX
A	---	2.05	---	0.081
A ₁	0.05	0.20	0.002	0.008
b	0.35	0.50	0.014	0.020
c	0.10	0.20	0.004	0.008
D	9.90	10.50	0.390	0.413
E	5.10	5.45	0.201	0.215
e	1.27 BSC		0.050 BSC	
H _E	7.40	8.20	0.291	0.323
0.50	0.50	0.85	0.020	0.033
L _E	1.10	1.50	0.043	0.059
M	0°	10°	0°	10°
Q ₁	0.70	0.90	0.028	0.035
Z	---	1.42	---	0.056

ON Semiconductor and are registered trademarks of Semiconductor Components Industries, LLC (SCILLC). SCILLC reserves the right to make changes without further notice to any products herein. SCILLC makes no warranty, representation or guarantee regarding the suitability of its products for any particular purpose, nor does SCILLC assume any liability arising out of the application or use of any product or circuit, and specifically disclaims any and all liability, including without limitation special, consequential or incidental damages. "Typical" parameters which may be provided in SCILLC data sheets and/or specifications can and do vary in different applications and actual performance may vary over time. All operating parameters, including "Typicals" must be validated for each customer application by customer's technical experts. SCILLC does not convey any license under its patent rights nor the rights of others. SCILLC products are not designed, intended, or authorized for use as components in systems intended for surgical implant into the body, or other applications intended to support or sustain life, or for any other application in which the failure of the SCILLC product could create a situation where personal injury or death may occur. Should Buyer purchase or use SCILLC products for any such unintended or unauthorized application, Buyer shall indemnify and hold SCILLC and its officers, employees, subsidiaries, affiliates, and distributors harmless against all claims, costs, damages, and expenses, and reasonable attorney fees arising out of, directly or indirectly, any claim of personal injury or death associated with such unintended or unauthorized use, even if such claim alleges that SCILLC was negligent regarding the design or manufacture of the part. SCILLC is an Equal Opportunity/Affirmative Action Employer. This literature is subject to all applicable copyright laws and is not for resale in any manner.

PUBLICATION ORDERING INFORMATION

LITERATURE FULFILLMENT:
Literature Distribution Center for ON Semiconductor
P.O. Box 5163, Denver, Colorado 80217 USA
Phone: 303-675-2175 or 800-344-3860 Toll Free USA/Canada
Fax: 303-675-2176 or 800-344-3867 Toll Free USA/Canada
Email: orderlit@onsemi.com

N. American Technical Support: 800-282-9855 Toll Free
USA/Canada
Europe, Middle East and Africa Technical Support:
Phone: 421 33 790 2910
Japan Customer Focus Center
Phone: 81-3-5773-3850

ON Semiconductor Website: www.onsemi.com
Order Literature: <http://www.onsemi.com/orderlit>
For additional information, please contact your local Sales Representative