

TOSHIBA TRANSISTOR SILICON NPN TRIPLE DIFFUSED MESA TYPE

2SD2498

HORIZONTAL DEFLECTION OUTPUT FOR HIGH RESOLUTION DISPLAY, COLOR TV

HIGH SPEED SWITCHING APPLICATIONS

- High Voltage : VCBO = 1500 V
- Low Saturation Voltage : VCE (sat) = 5 V (Max.)
- High Speed : tf = 0.4 μs (Typ.)
- Collector Metal (Fin) is Fully Covered with Mold Resin

MAXIMUM RATINGS (Tc = 25°C)

CHARACTERISTIC		SYMBOL	RATING	UNIT
Collector-Base Voltage		VCBO	1500	V
Collector-Emitter Voltage		VCEO	600	V
Emitter-Base Voltage		VEBO	5	V
Collector Current	DC	IC	6	A
	Pulse	ICP	12	
Base Current		IB	3	A
Collector Power Dissipation		PC	50	W
Junction Temperature		Tj	150	°C
Storage Temperature Range		Tstg	-55~150	°C

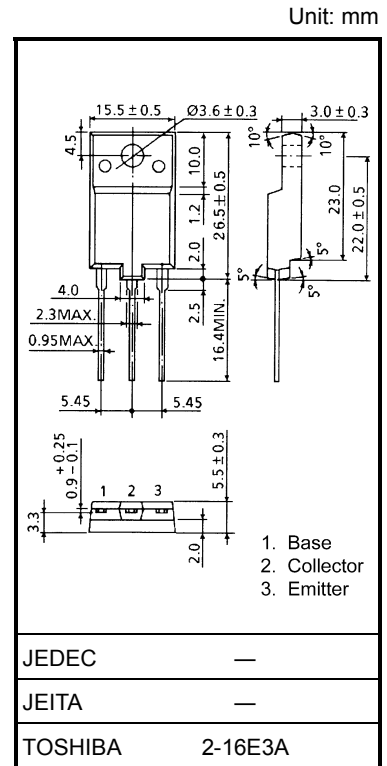

Weight: 5.5 g (typ.)

MARKING

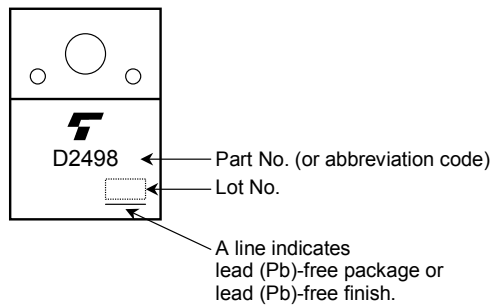

ELECTRICAL CHARACTERISTICS (Tc = 25°C)

CHARACTERISTIC	SYMBOL	TEST CONDITION	MIN	TYP.	MAX	UNIT
Collector Cut-off Current	I _{CBO}	V _{CB} = 1500 V, I _E = 0	—	—	1	mA
Emitter Cut-off Current	I _{EBO}	V _{EB} = 5 V, I _C = 0	—	—	10	μA
Collector-Emitter Breakdown Voltage	V _{(BR) CEO}	I _C = 10 mA, I _B = 0	600	—	—	V
DC Current Gain	h _{FE} (1)	V _{CE} = 5 V, I _C = 1 A	10	—	30	—
	h _{FE} (2)	V _{CE} = 5 V, I _C = 4 A	5	—	9	
Collector-Emitter Saturation Voltage	V _{CE (sat)}	I _C = 4 A, I _B = 0.8 A	—	—	5	V
Base-Emitter Saturation Voltage	V _{BE (sat)}	I _C = 4 A, I _B = 0.8 A	—	0.9	1.2	V
Transition Frequency	f _T	V _{CE} = 10 V, I _C = 0.1 A	—	2	—	MHz
Collector Output Capacitance	C _{ob}	V _{CB} = 10 V, I _E = 0, f = 1 MHz	—	95	—	pF
Switching Time (Fig.1)	Storage Time	I _{CP} = 4 A, I _{B1} (end) = 0.8 A f _H = 15.75 kHz	—	7	10	μs
	Fall Time		—	0.4	0.7	

Fig.1 SWITCHING TIME TEST CIRCUIT

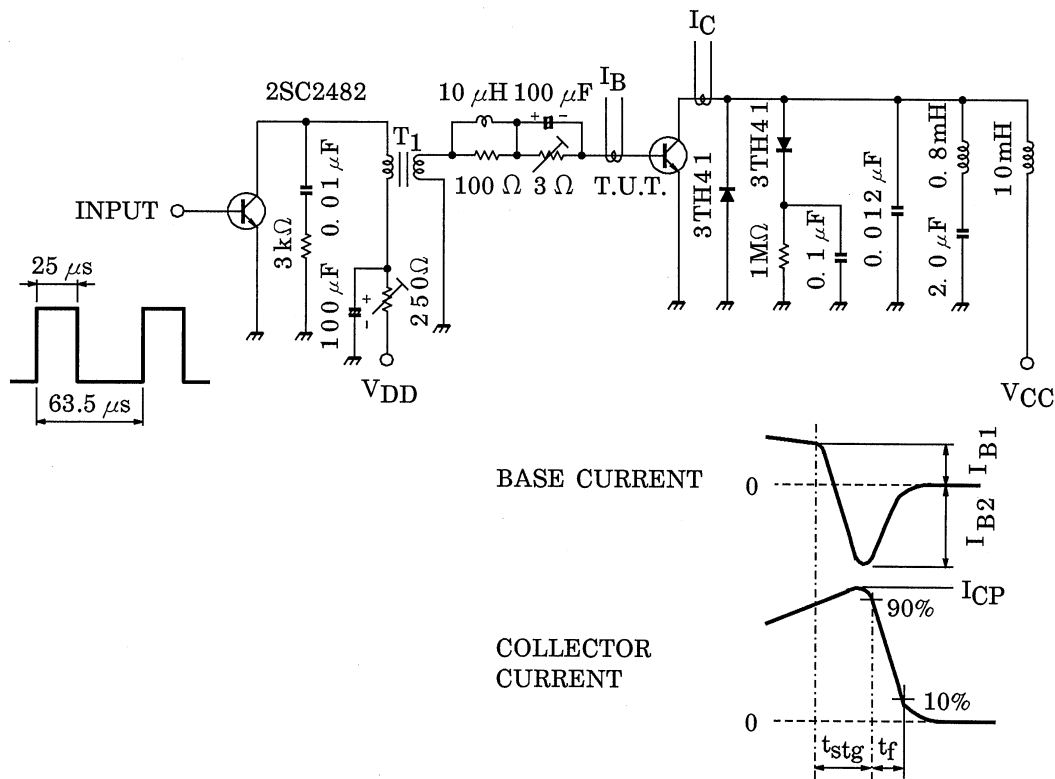

Base Current Gradient

$$dI_B / dt = \frac{I_{B1} + I_{B2}}{t_{stg}} \text{ (A / } \mu\text{s)}$$

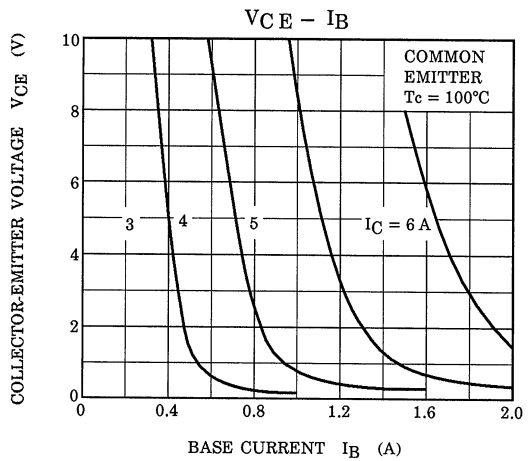
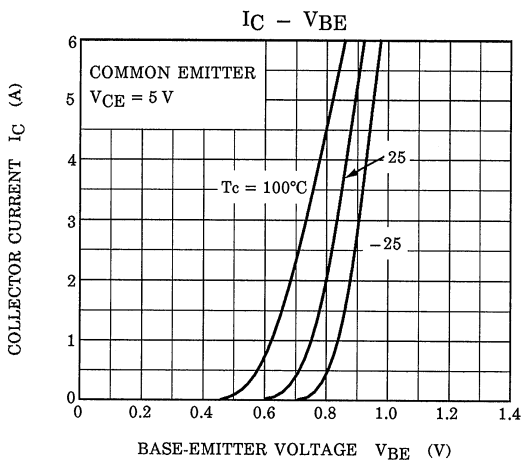
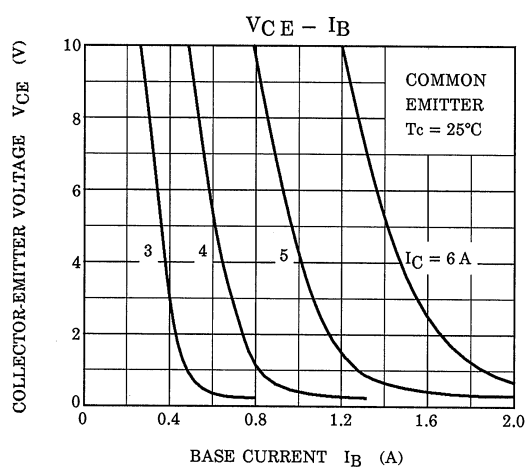
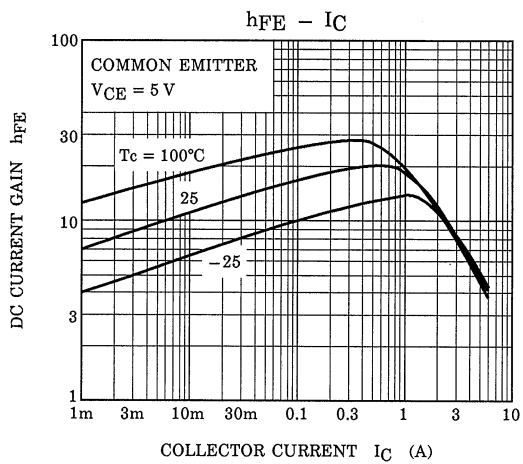
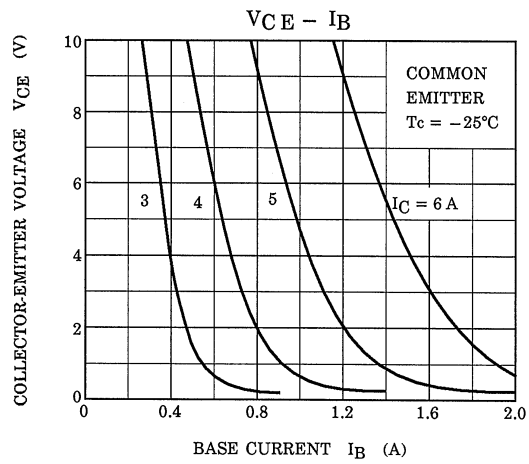
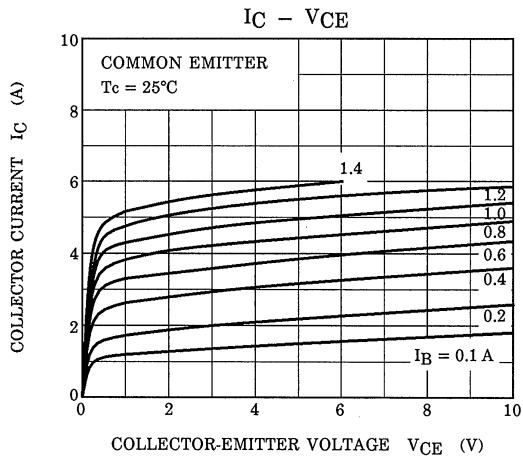

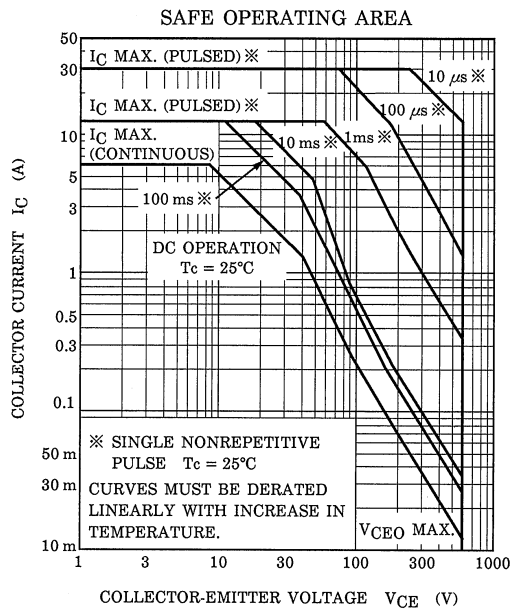
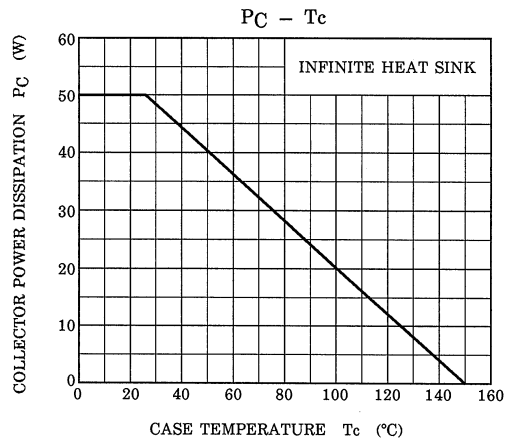
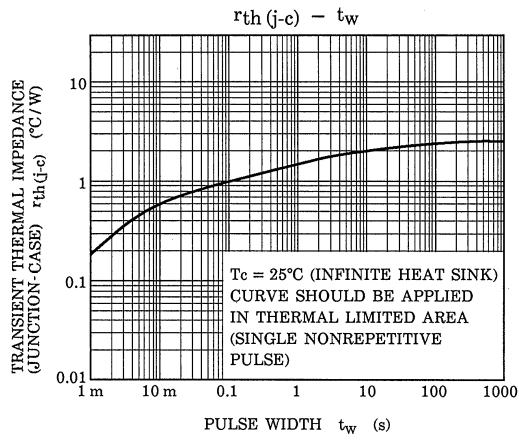

RESTRICTIONS ON PRODUCT USE

030619EAA

- The information contained herein is subject to change without notice.
- The information contained herein is presented only as a guide for the applications of our products. No responsibility is assumed by TOSHIBA for any infringements of patents or other rights of the third parties which may result from its use. No license is granted by implication or otherwise under any patent or patent rights of TOSHIBA or others.
- TOSHIBA is continually working to improve the quality and reliability of its products. Nevertheless, semiconductor devices in general can malfunction or fail due to their inherent electrical sensitivity and vulnerability to physical stress. It is the responsibility of the buyer, when utilizing TOSHIBA products, to comply with the standards of safety in making a safe design for the entire system, and to avoid situations in which a malfunction or failure of such TOSHIBA products could cause loss of human life, bodily injury or damage to property.
In developing your designs, please ensure that TOSHIBA products are used within specified operating ranges as set forth in the most recent TOSHIBA products specifications. Also, please keep in mind the precautions and conditions set forth in the "Handling Guide for Semiconductor Devices," or "TOSHIBA Semiconductor Reliability Handbook" etc..
- The TOSHIBA products listed in this document are intended for usage in general electronics applications (computer, personal equipment, office equipment, measuring equipment, industrial robotics, domestic appliances, etc.). These TOSHIBA products are neither intended nor warranted for usage in equipment that requires extraordinarily high quality and/or reliability or a malfunction or failure of which may cause loss of human life or bodily injury ("Unintended Usage"). Unintended Usage include atomic energy control instruments, airplane or spaceship instruments, transportation instruments, traffic signal instruments, combustion control instruments, medical instruments, all types of safety devices, etc.. Unintended Usage of TOSHIBA products listed in this document shall be made at the customer's own risk.
- TOSHIBA products should not be embedded to the downstream products which are prohibited to be produced and sold, under any law and regulations.