



STGF20NB60S

N-CHANNEL 13A - 600V TO-220FP

PowerMESH™ IGBT

Table 1: General Features

TYPE	V _{CES}	V _{CE(sat)} (Max) @ 25°C	I _C @ 100°C
STGF20NB60S	600 V	< 1.7 V	13 A

- LOW ON-VOLTAGE DROP (V_{cesat})
- HIGH CURRENT CAPABILITY
- OFF LOSSES INCLUDE TAIL CURRENT
- HIGH INPUT IMPEDANCE (VOLTAGE DRIVEN)

DESCRIPTION

Using the latest high voltage technology based on a patented strip layout, STMicroelectronics has designed an advanced family of IGBTs, the PowerMESH™ IGBTs, with outstanding performances. The suffix "S" identifies a family optimized to achieve minimum on-voltage drop for low frequency to applications (<1kHz).

APPLICATIONS

- LIGHT DIMMER
- STATIC RELAYS
- MOTOR CONTROL

Figure 1: Package

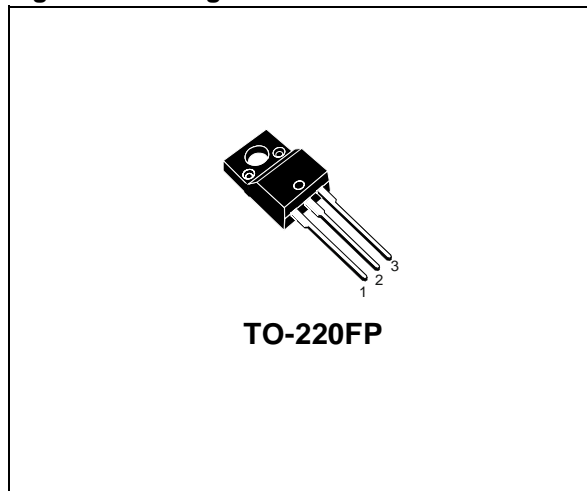

Figure 2: Internal Schematic Diagram

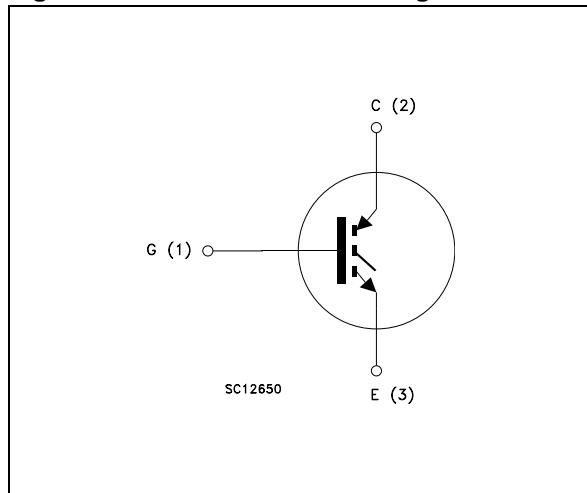

Table 2: Order Code

PART NUMBER	MARKING	PACKAGE	PACKAGING
STGF20NB60S	GF20NB60S	TO-220FP	TUBE

Table 3: Absolute Maximum ratings

Symbol	Parameter	Value	Unit
V _{CES}	Collector-Emitter Voltage (V _{GS} = 0)	600	V
V _{ECR}	Emitter-Collector Voltage	20	V
V _{GE}	Gate-Emitter Voltage	±20	V
I _C	Collector Current (continuous) at T _C = 25°C (#)	24	A
I _C	Collector Current (continuous) at T _C = 100°C (#)	13	A
I _{CM} (■)	Collector Current (pulsed)	70	A
P _{TOT}	Total Dissipation at T _C = 25°C	40	W
	Derating Factor	0.32	W/°C
V _{ISO}	Insulation withstand voltage AC (t=1sec, T _c =25°C)	2500	V
T _{stg}	Storage Temperature	-55 to 150	°C
T _j	Operating Junction Temperature range		

(■) Pulse width limited by safe operating area

Table 4: Thermal Data

		Min.	Typ.	Max.	
R _{thj-case}	Thermal Resistance Junction-case			3.15	°C/W
R _{thj-amb}	Thermal Resistance Junction-ambient			62.5	°C/W
T _L	Maximum Lead Temperature for Soldering Purpose (1.6 mm from case, for 10 sec.)		300		°C

ELECTRICAL CHARACTERISTICS (T_{CASE} =25°C UNLESS OTHERWISE SPECIFIED)
Table 5: On/Off

Symbol	Parameter	Test Conditions	Min.	Typ.	Max.	Unit
V _{BR(CES)}	Collector-Emitter Breakdown Voltage	I _C = 250 μA, V _{GE} = 0	600			V
V _{BR(ECS)}	Emitter-Collector Breakdown Voltage	I _C = 1mA, V _{GE} = 0	20			V
I _{CES}	Collector cut-off Current (V _{GE} = 0)	V _{CE} = Max Rating, T _C = 25 °C V _{CE} = Max Rating, T _C = 125 °C			10 100	μA μA
I _{GES}	Gate-Emitter Leakage Current (V _{CE} = 0)	V _{GE} = ± 20V, V _{CE} = 0			±100	nA
V _{GE(th)}	Gate Threshold Voltage	V _{CE} = V _{GE} , I _C = 250 μA	2.5		5	V
V _{CE(sat)}	Collector-Emitter Saturation Voltage	V _{GE} = 15V, I _C = 20 A, T _j = 25°C V _{GE} = 15V, I _C = 20A, T _j =150°C		1.25 1.2	1.7	V V

(#) Calculated according to the iterative formula:

$$I_C(T_C) = \frac{T_{JMAX} - T_C}{R_{THJ-C} \times V_{CESAT(MAX)}(T_C, I_C)}$$

ELECTRICAL CHARACTERISTICS (CONTINUED)

Table 6: Dynamic

Symbol	Parameter	Test Conditions	Min.	Typ.	Max.	Unit
g_{fs} (1)	Forward Transconductance	$V_{CE} = 10 \text{ V}$, $I_C = 8 \text{ A}$		20		S
C_{ies}	Input Capacitance	$V_{CE} = 25 \text{ V}$, $f = 1 \text{ MHz}$, $V_{GE} = 0$		1820		pF
C_{oes}	Output Capacitance			167		pF
C_{res}	Reverse Transfer Capacitance			27		pF
Q_g Q_{ge} Q_{gc}	Total Gate Charge Gate-Emitter Charge Gate-Collector Charge	$V_{CC} = 480 \text{ V}$, $I_C = 20 \text{ A}$, $V_{GE} = 15 \text{ V}$ (see Figure 19)		83 10 27	115	nC nC nC
I_{CL}	Turn-off SOA minimum current	$V_{clamp} = 480 \text{ V}$, $T_j = 125^\circ\text{C}$ $R_G = 100 \Omega$	80			A

(1) Pulsed: Pulse duration= 300 μs , duty cycle 1.5%

Table 7: Switching On

Symbol	Parameter	Test Conditions	Min.	Typ.	Max.	Unit	
$t_{d(on)}$ t_r $(di/dt)_{on}$	Turn-on Delay Time Current Rise Time Turn-on Current Slope	$V_{CC} = 480 \text{ V}$, $I_C = 20 \text{ A}$ $R_G = 100 \Omega$, $V_{GE} = 15 \text{ V}$ (see Figure 17)		92 70 340		ns ns A/ μs	
$t_{d(on)}$ t_r $(di/dt)_{on}$	Turn-on Delay Time Current Rise Time Turn-on Delay Time		$V_{CC} = 480 \text{ V}$, $I_C = 20 \text{ A}$ $R_G = 100 \Omega$, $V_{GE} = 15 \text{ V}$, $T_j = 125^\circ\text{C}$ (see Figure 17)		80 73 320		ns ns A/ μs

Table 8: Switching Off

Symbol	Parameter	Test Conditions	Min.	Typ.	Max.	Unit	
t_c $t_r(V_{off})$ $t_{d(off)}$ t_f	Cross-over Time Off Voltage Rise Time Turn-off Delay Time Current Fall Time	$V_{CC} = 480 \text{ V}$, $I_C = 20 \text{ A}$, $R_G = 100 \Omega$, $V_{GE} = 15 \text{ V}$ $T_J = 25^\circ\text{C}$ (see Figure 17)		1.6 0.78 1.1 0.79		μs μs μs μs	
t_c $t_r(V_{off})$ $t_{d(off)}$ t_f	Cross-over Time Off Voltage Rise Time Turn-off Delay Time Current Fall Time		$V_{CC} = 480 \text{ V}$, $I_C = 20 \text{ A}$, $R_G = 100 \Omega$, $V_{GE} = 15 \text{ V}$ $T_j = 125^\circ\text{C}$ (see Figure 17)		2.4 1.1 2.4 1.2		μs μs μs μs

Table 9: Switching Energy

Symbol	Parameter	Test Conditions	Min.	Typ.	Max.	Unit
E_{on} (2) E_{off} (3) E_{ts}	Turn-on Switching Losses Turn-off Switching Loss Total Switching Loss	$V_{CC} = 480 \text{ V}$, $I_C = 20 \text{ A}$ $R_G = 100 \Omega$, $V_{GE} = 15 \text{ V}$, (see Figure 18)		0.84 7.4 8.24		mJ mJ mJ
E_{on} (2) E_{off} (3) E_{ts}	Turn-on Switching Losses Turn-off Switching Loss Total Switching Loss		$V_{CC} = 480 \text{ V}$, $I_C = 20 \text{ A}$ $R_G = 100 \Omega$, $V_{GE} = 15 \text{ V}$, $T_j = 125^\circ\text{C}$ (see Figure 18)		0.86 11.5 12.4	

(2) E_{on} is the turn-on losses when a typical diode is used in the test circuit in figure 2. If the IGBT is offered in a package with a co-pack diode, the co-pack diode is used as external diode.

(3) Turn-off losses include also the tail of the collector current.

Figure 3: Output Characteristics

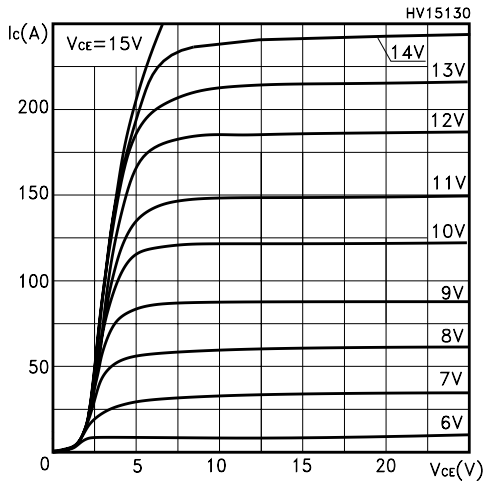

Figure 4: Transconductance

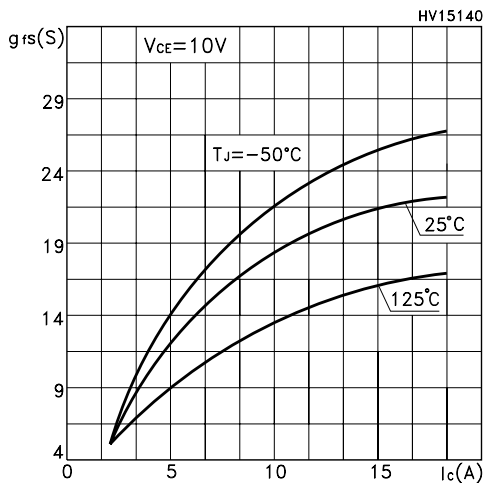

Figure 5: Collector-Emitter On Voltage vs Collector Current

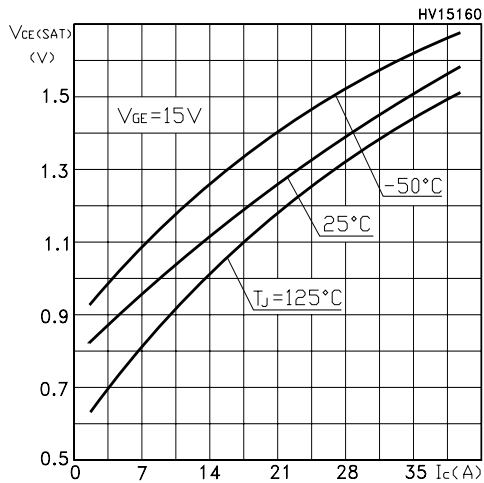

Figure 6: Transfer Characteristics

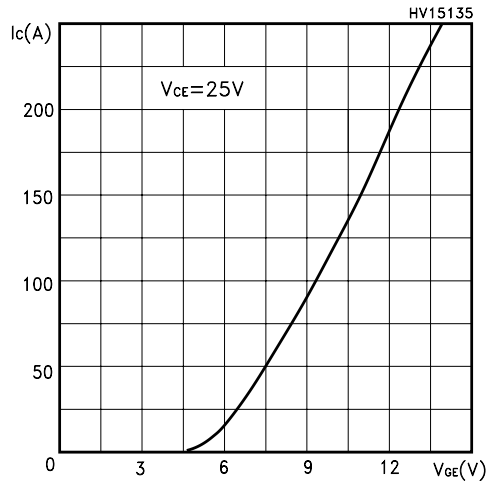

Figure 7: Normalized Collector-Emitter On Voltage vs Temperature

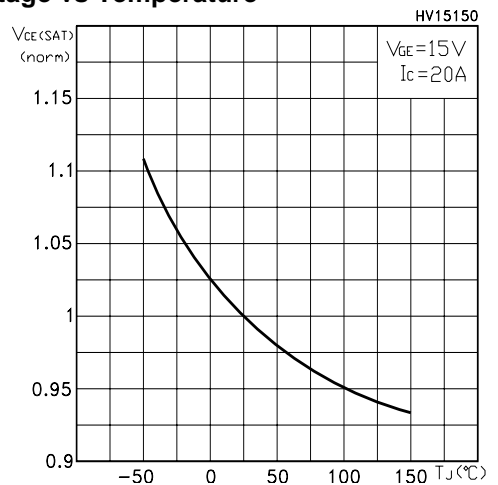

Figure 8: Gate Threshold vs Temperature

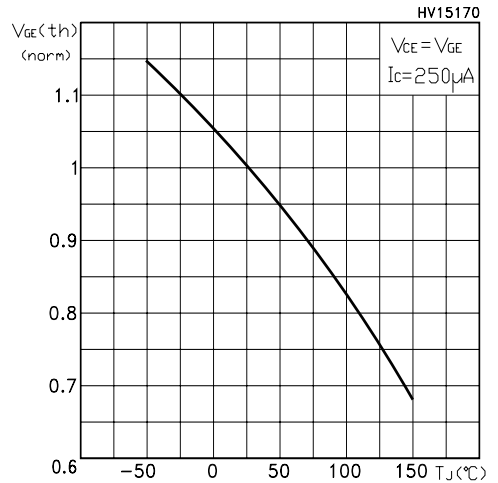

Figure 9: Normalized Breakdown Voltage vs Temperature

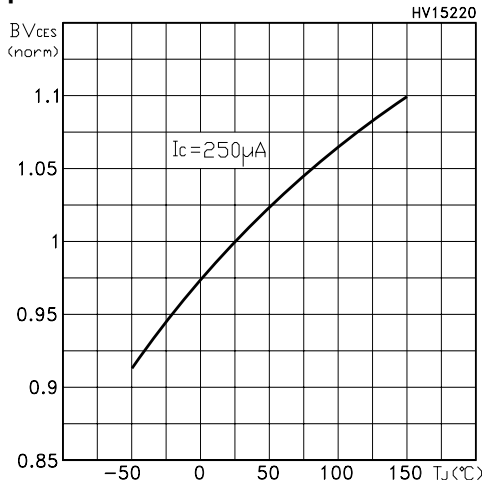

Figure 10: Capacitance Variations

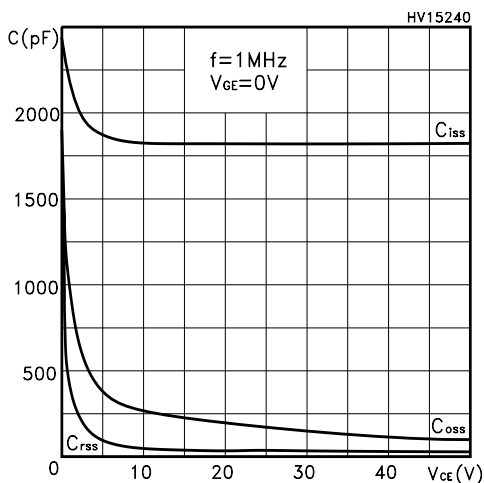

Figure 11: Switching Losses vs Temperature

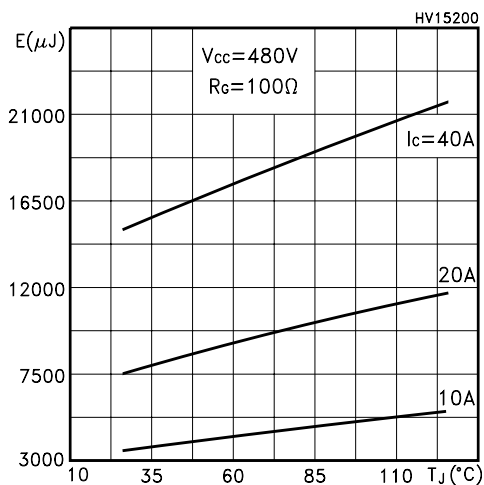

Figure 12: Gate Charge vs Gate-Emitter Voltage

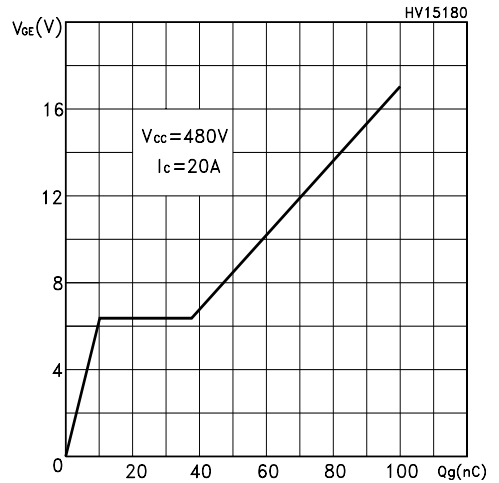

Figure 13: Switching Losses vs Gate Charge

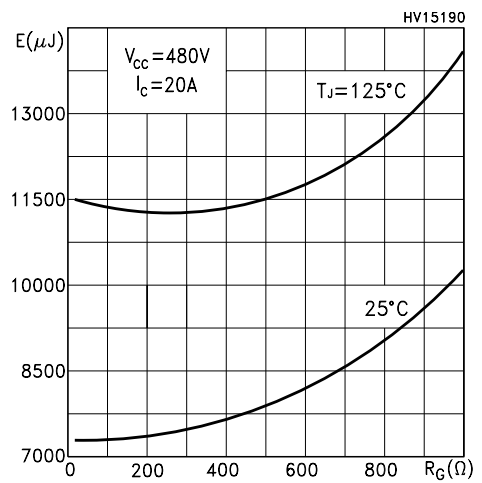

Figure 14: Switching Losses vs Collector Current

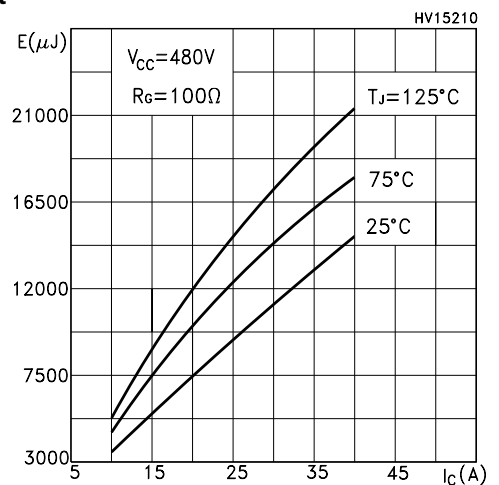

Figure 15: Thermal Impedance

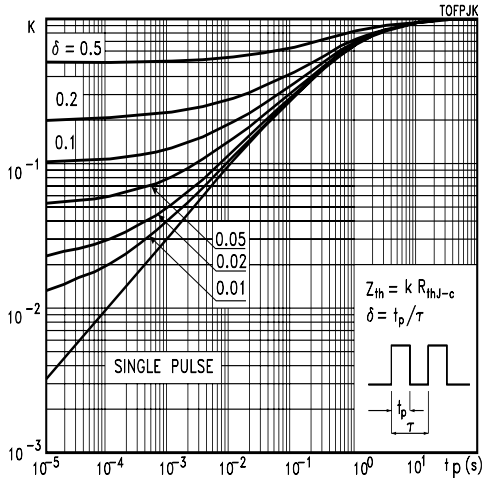

Figure 16: Collector-Emitter Diode Characteristics

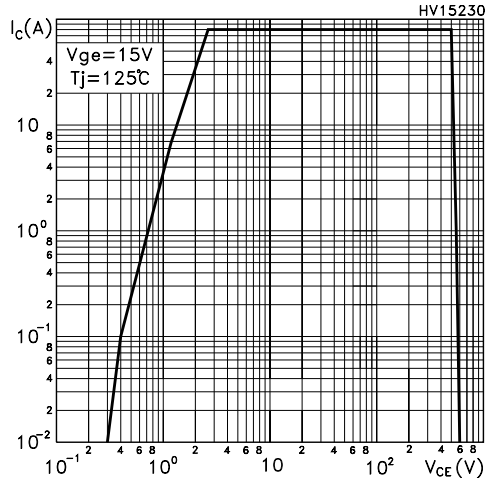

Figure 17: Test Circuit for Inductive Load Switching

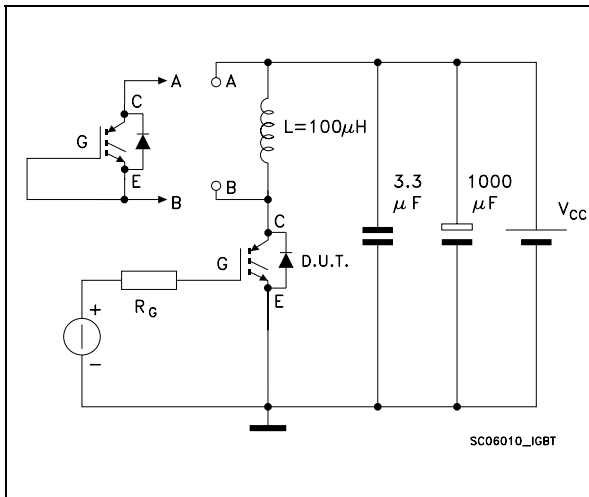

Figure 18: Switching Waveforms

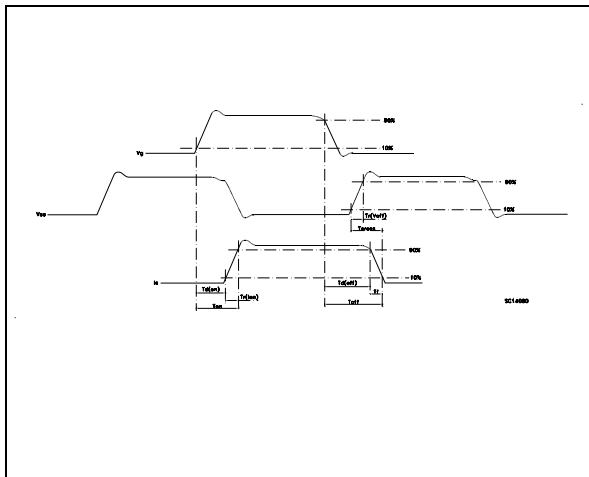
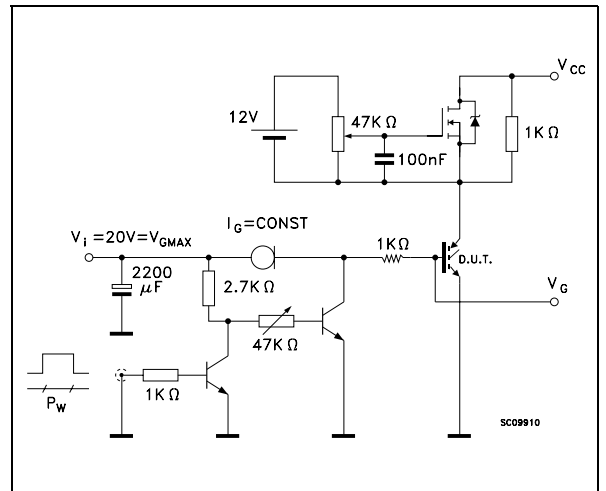

Figure 19: Gate Charge Test Circuit



TO-220FP MECHANICAL DATA

DIM.	mm.			inch		
	MIN.	TYP	MAX.	MIN.	TYP.	MAX.
A	4.4		4.6	0.173		0.181
B	2.5		2.7	0.098		0.106
D	2.5		2.75	0.098		0.108
E	0.45		0.7	0.017		0.027
F	0.75		1	0.030		0.039
F1	1.15		1.7	0.045		0.067
F2	1.15		1.7	0.045		0.067
G	4.95		5.2	0.195		0.204
G1	2.4		2.7	0.094		0.106
H	10		10.4	0.393		0.409
L2		16			0.630	
L3	28.6		30.6	1.126		1.204
L4	9.8		10.6	.0385		0.417
L5	2.9		3.6	0.114		0.141
L6	15.9		16.4	0.626		0.645
L7	9		9.3	0.354		0.366
Ø	3		3.2	0.118		0.126

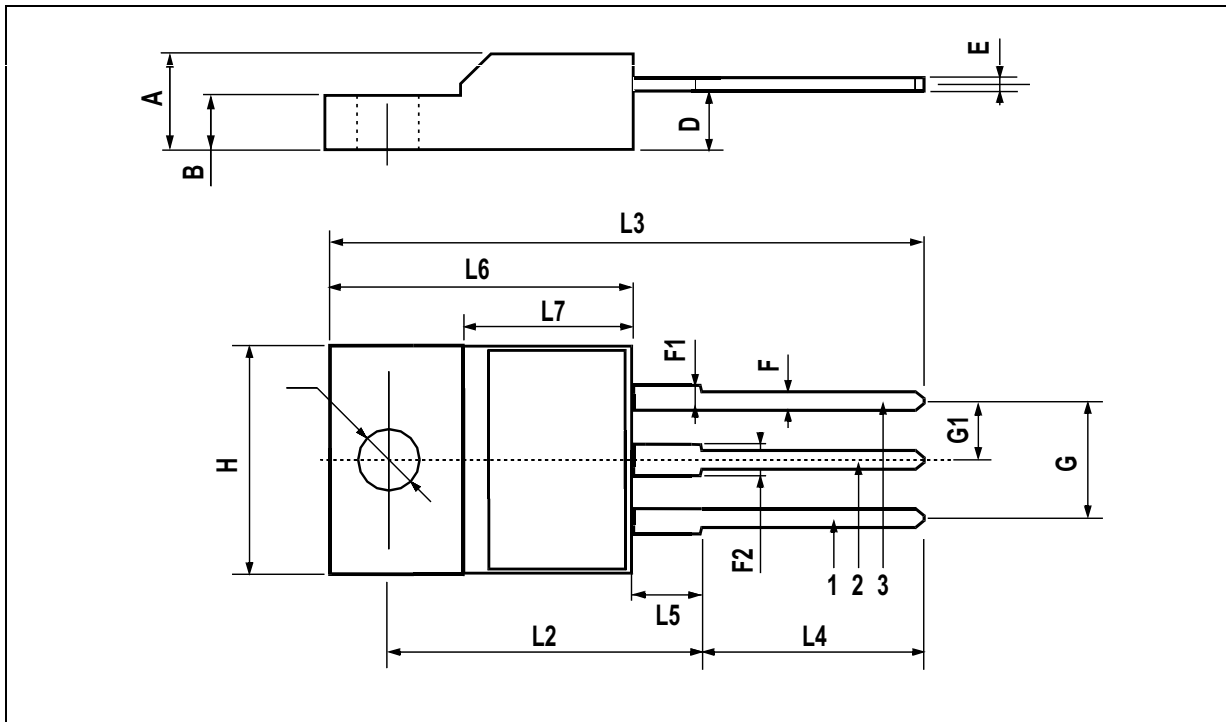

Table 10: Revision History

Date	Revision	Description of Changes
17-Dec-2004	2	New template, no content change

Information furnished is believed to be accurate and reliable. However, STMicroelectronics assumes no responsibility for the consequences of use of such information nor for any infringement of patents or other rights of third parties which may result from its use. No license is granted by implication or otherwise under any patent or patent rights of STMicroelectronics. Specifications mentioned in this publication are subject to change without notice. This publication supersedes and replaces all information previously supplied. STMicroelectronics products are not authorized for use as critical components in life support devices or systems without express written approval of STMicroelectronics.

The ST logo is a registered trademark of STMicroelectronics

All other names are the property of their respective owners

© 2005 STMicroelectronics - All Rights Reserved

STMicroelectronics group of companies

Australia - Belgium - Brazil - Canada - China - Czech Republic - Finland - France - Germany - Hong Kong - India - Israel - Italy - Japan - Malaysia - Malta - Morocco - Singapore - Spain - Sweden - Switzerland - United Kingdom - United States of America