

# KA311

## Single Comparator

### General Description

The KA311 series is a monolithic, low input current voltage comparator. The device is also designed to operate from dual or single supply voltage.

### Features

- Low Input Bias Current: 250nA (Max)
- Low Input Offset Current: 50nA (Max)
- Differential Input Voltage:  $\pm 30V$
- Power Supply Voltage:
  - Single 5.0V to 30V or 15V Split Supplies ( $\pm 15V$ )
- Offset Voltage Null Capability
- Strobe Capability

### Ordering Information:

Product Number	Package	Operating Temperature
KA311	8-DIP	0 ~ +70°C
KA311DTF	8-SOP	

8-DIP



8-SOP



### Internal Block Diagram

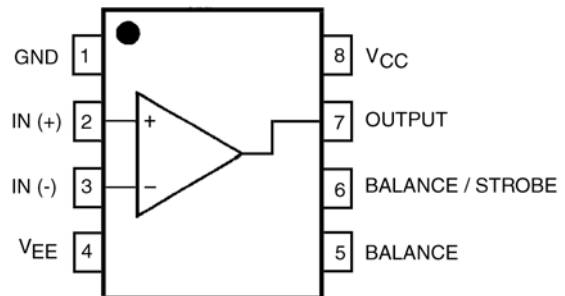

### Schematic Diagram

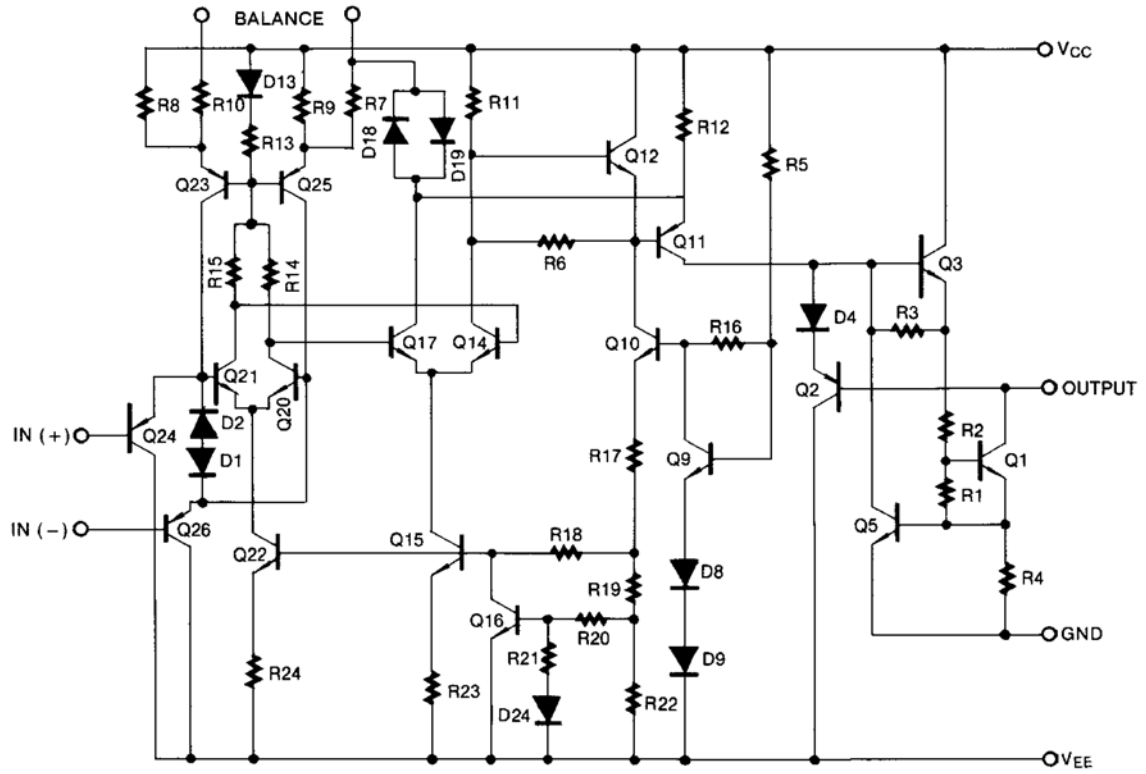

## Absolute Maximum Ratings (Note 1)

Parameter	Symbol	Value	Unit
Total Supply Voltage	$V_{CC} +  V_{EE} $	36	V
Output to Negative Supply Voltage KA311	$V_O - V_{EE}$	40	V
Ground to Negative voltage	$V_{EE}$	-30	V
Differential Input Voltage	$V_{I(DIFF)}$	30	V
Input Voltage	$V_I$	15	V
Output Short Circuit Duration	–	10	sec.
Power Dissipation	$P_D$	500	mW
Operating Temperature Range	$T_{OPR}$	0 ~ +70	°C
Storage Temperature Range	$T_{STG}$	-65 ~ +150	°C

**Note 1:** The "Absolute Maximum Ratings" are those values beyond which the safety of the device cannot be guaranteed. The device should not be operated at these limits. The parametric values defined in the Electrical Characteristics tables are not guaranteed at the absolute maximum ratings. The "Recommended Operating Conditions" table will define the conditions for actual device operation.

## Electrical Characteristics ( $V_{CC} = 15V$ , $V_{EE} = -15V$ , $T_A = 25^\circ C$ , unless otherwise specified)

Parameter	Symbol	Conditions	Min	Typ	Max	Unit
Input Offset Voltage	$V_{IO}$	$RS \leq 50k\Omega$	–	1.0	7.5	mV
		(Note 2)	–	–	10.0	
Input Offset Current	$I_{IO}$		–	6.0	50.0	nA
		(Note 2)	–	–	70.0	
Input Bias Current	$I_{BIAS}$		–	100	250	nA
		(Note 2)	–	–	300	
Voltage Gain	$G_V$		40.0	200	–	V/mV
Response Time	$t_{RES}$	(Note 3)	–	200	–	ns
Saturation Voltage	$V_{SAT}$	$I_O = 50mA$ , $V_I \leq -10mV$	–	0.75	1.5	V
		$V_{CC} \geq 4.5V$ , $V_{EE} = 0V$ , $I_O = 8mA$ , $V_I \leq -10mV$ (Note 2)	–	0.23	0.4	
Strobe "ON" Current	$I_{STR(ON)}$		–	3.0	–	mA
Output Leakage Current	$I_{SINK}$	$I_{STR} = 3mA$ , $V_I \geq 10mV$ , $V_O = 15V$ , $V_{CC} = \pm 15V$	–	0.2	50.0	nA
Input Voltage Range	$V_{I(R)}$	(Note 2)	-14.5 to 13.0	-14.7 to 13.8	–	V
Positive Supply Current	$I_{CC}$		–	3.0	7.5	mA
Negative Supply Current	$I_{EE}$		–	-2.2	-5.0	mA
Strobe Current	$I_{STR}$		–	3.0	–	mA

**Note 2:**  $0 \leq T_A \leq +70^\circ C$ .

**Note 3:** The response time specified is for a 100mV input step with 5mV over drive.

# Typical Performance Characteristics

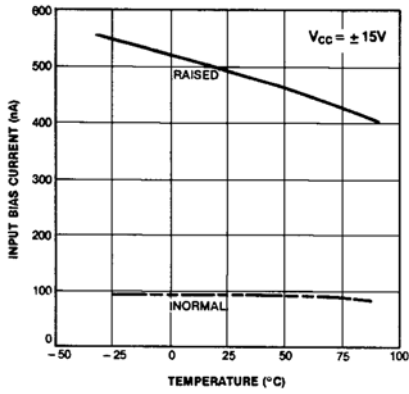

FIGURE 1. Input Bias Current vs. Temperature

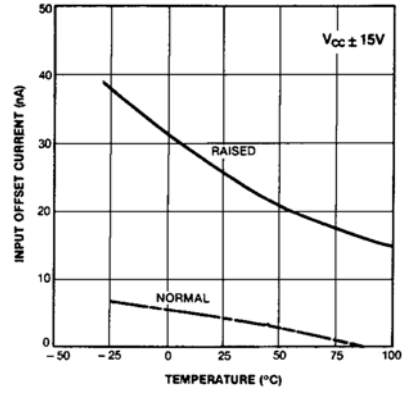

FIGURE 2. Input Offset Current vs. Temperature

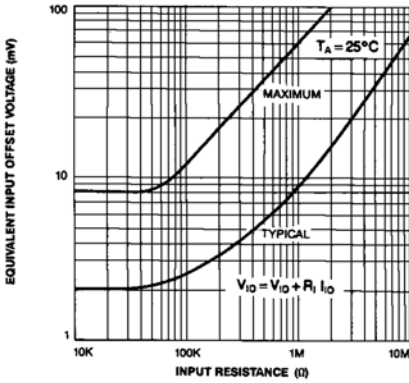

FIGURE 3. Offset Voltage vs. Input Resistance

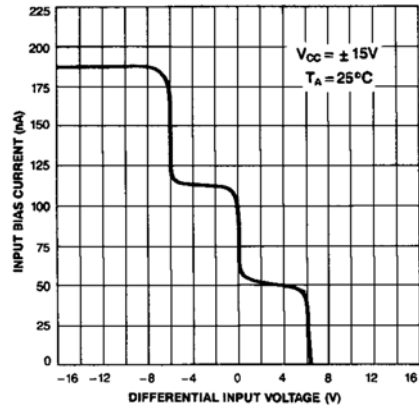

FIGURE 4. Input Bias Current vs. Differential Input Voltage

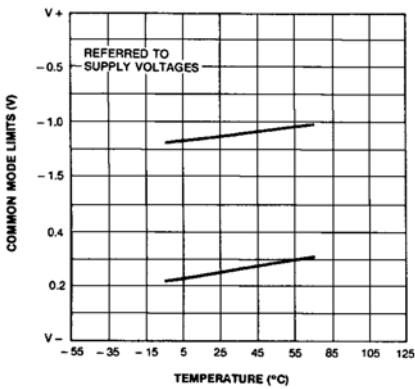

FIGURE 5. Common Mode Limits vs. Temperature

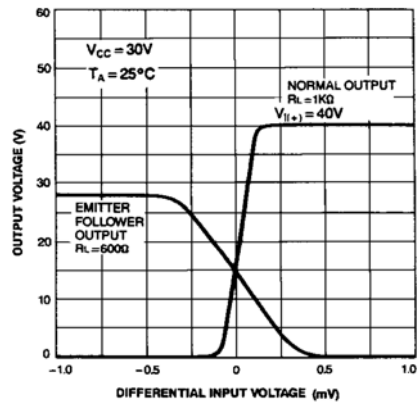

FIGURE 6. Output Voltage vs. Differential Input Voltage

Typical Performance Characteristics (Continued)

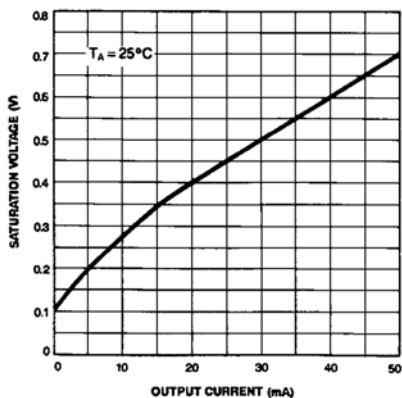

FIGURE 7. Saturation Voltage vs. Current

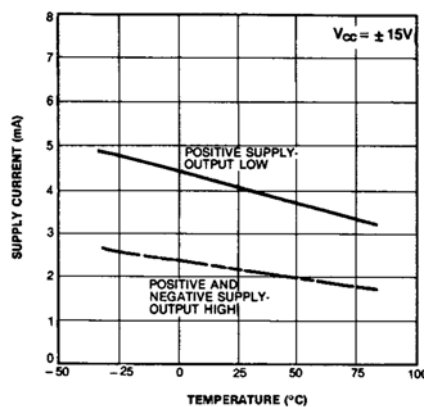

FIGURE 8. Supply Current vs. Temperature

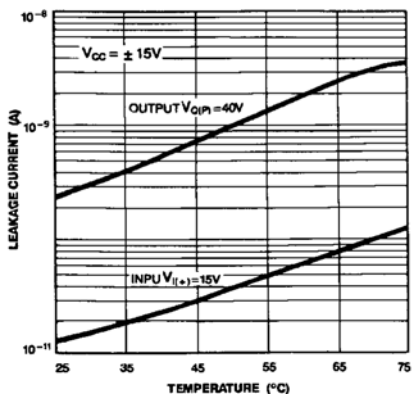

FIGURE 9. Leakage Current vs. Temperature

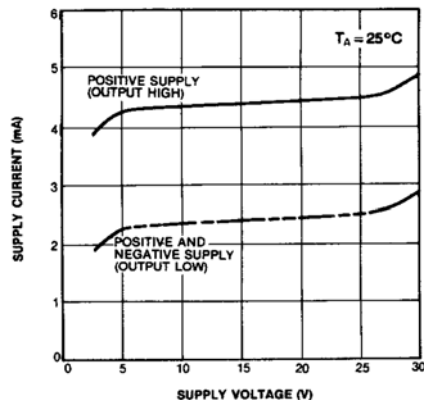

FIGURE 10. Supply Current vs. Supply Voltage

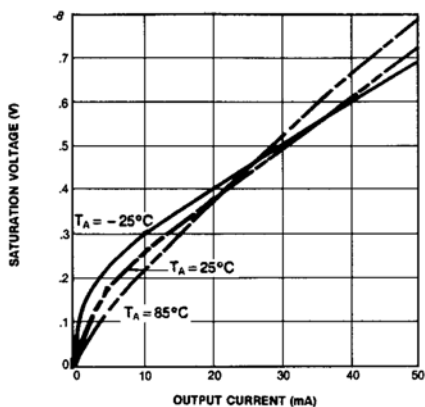

FIGURE 11. Current Saturation Voltage

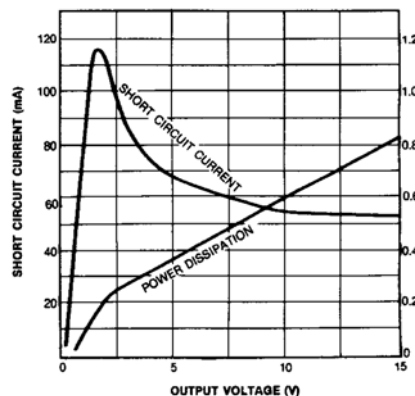
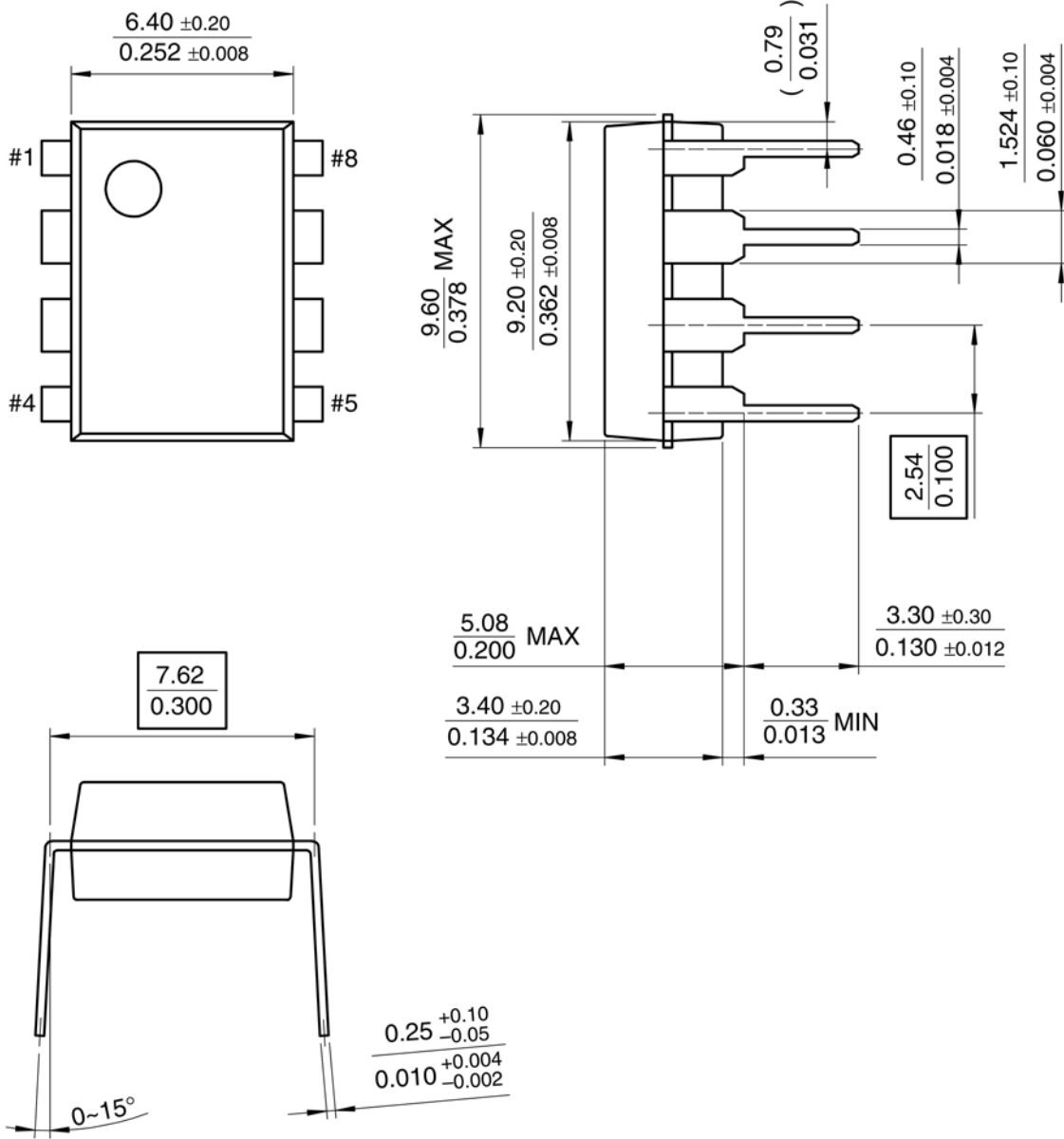

FIGURE 12. Output Limiting Characteristics

**Physical Dimensions** inches (millimeters) unless otherwise noted

**8-DIP**



**8-Lead Dual-In-Line Package**

Physical Dimensions inches (millimeters) unless otherwise noted (Continued)

# 8-SOP

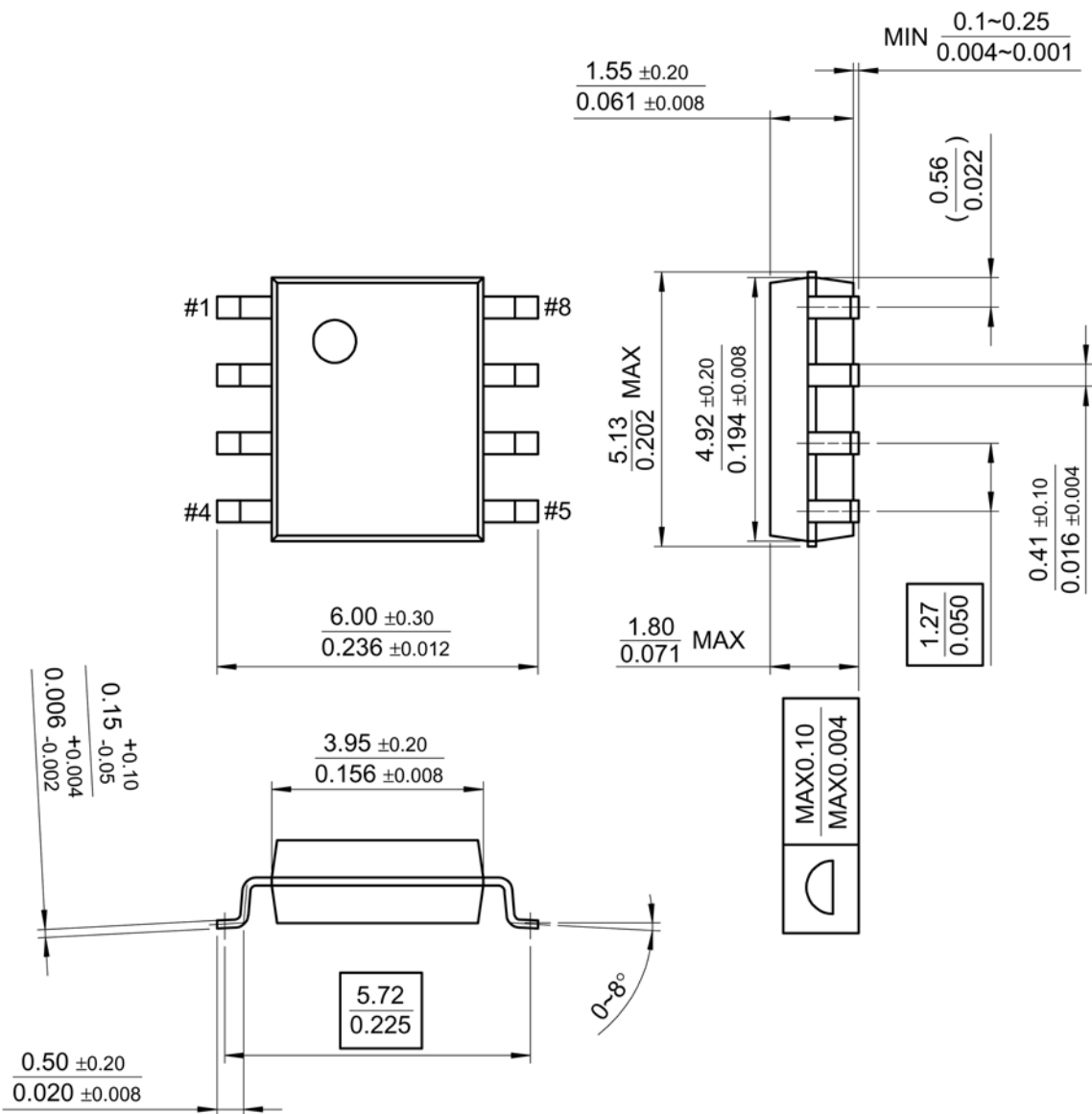

8-Lead Small Outline Package

**DISCLAIMER**

FAIRCHILD SEMICONDUCTOR RESERVES THE RIGHT TO MAKE CHANGES WITHOUT FURTHER NOTICE TO ANY PRODUCTS HEREIN TO IMPROVE RELIABILITY, FUNCTION OR DESIGN. FAIRCHILD DOES NOT ASSUME ANY LIABILITY ARISING OUT OF THE APPLICATION OR USE OF ANY PRODUCT OR CIRCUIT DESCRIBED HEREIN; NEITHER DOES IT CONVEY ANY LICENSE UNDER ITS PATENT RIGHTS, NOR THE RIGHTS OF OTHERS.

**LIFE SUPPORT POLICY**

FAIRCHILD'S PRODUCTS ARE NOT AUTHORIZED FOR USE AS CRITICAL COMPONENTS IN LIFE SUPPORT DEVICES OR SYSTEMS WITHOUT THE EXPRESS WRITTEN APPROVAL OF FAIRCHILD SEMICONDUCTOR CORPORATION

As used herein:

1. Life support devices or systems are devices or systems which, (a) are intended for surgical implant into the body, or (b) support or sustain life, or (c) whose failure to perform when properly used in accordance with instructions for use

provided in the labeling, can be reasonably expected to result in significant injury to the user.

2. A critical component is any component of a life support device or system whose failure to perform can be reasonably expected to cause the failure of the life support device or system, or to affect its safety or effectiveness.

**PRODUCT STATUS DEFINITIONS**

Definition of terms

Datasheet Identification	Product Status	Definition
Advance Information	Formative or In Design	This datasheet contains the design specifications for product development. Specifications may change in any manner without notice.
Preliminary	First Production	This datasheet contains preliminary data, and supplementary data will be published at a later date. Fairchild Semiconductor reserves the right to make changes at any time without notice in order to improve design.
No Identification Needed	Full Production	This datasheet contains final specifications. Fairchild Semiconductor reserves the right to make changes at any time without notice in order to improve design.
Obsolete	Not In Production	This datasheet contains specifications on a product that has been discontinued by Fairchild Semiconductor. The datasheet is printed for reference information only.