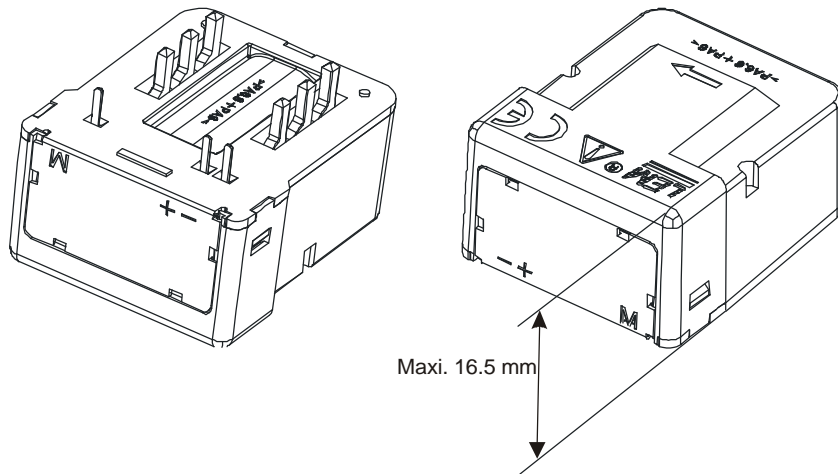


Current Transducer LAX SERIES

 $I_{PN} = 16 - 100 \text{ A}$

Ref: LAX 100-NP

For the electronic measurement of currents: DC, AC, pulsed , with a galvanic isolation between the primary circuit (high power) and the secondary circuit (electronic circuit).



Features

- Closed loop (compensated) current transducer using the hall effect
- Printed circuit board mounting
- Isolated plastic case recognized according to UL 94-V0
- Multirange with a single device: 16, 25, 33, 50 and 100 A rms
- 3 independent primary jumpers.

Advantages

- Excellent accuracy
- Very good linearity
- Low temperature drift
- Optimized response time
- Wide frequency bandwidth
- No insertion losses
- High immunity to external interference
- Current overload capability
- Height less than 16.5 mm for a simplified integration with power modules
- Low primary inductance.

Applications

- AC variable speed drives and servo motor drives
- Static converters for DC motor drives
- Battery supplied applications
- Uninterruptible Power Supplies (UPS)
- Switched Mode Power Supplies (SMPS)
- Power supplies for welding applications.

Standards

- EN 50178
- UL508 - UR marking
- IEC 61010-1-safety.

Application Domain

- Industrial.

Electrical data

At $T_A = 25^\circ\text{C}$, $V_C = \pm 15\text{ V}$ and $R_M = 50\ \Omega$, $N_P = 1$ turn, high speed PCB design (see page 11), unless otherwise noted. Parameters with a * in the conditions column apply over the $-40^\circ\text{C}..85^\circ\text{C}$ ambient temperature range.

Parameter	Symbol	Unit	Mini	Typ	Maxi	Conditions
Primary nominal current rms	I_{PN}	At			100	Apply derating according to fig. 2
Primary current, measuring range	I_{PM}	At	± 160			* $V_C = \pm 15\text{ V} \pm 5\%$
Measuring resistance	R_M	Ω	49		51	* $V_C = \pm 15\text{ V} \pm 5\%$, $\pm I_{PM}$ measuring range, DC primary current
			0		51	* $V_C = \pm 15\text{ V} \pm 5\%$, $\pm I_{PM}$ measuring range, AC primary current
			0		15	* $V_C = \pm 12\text{ V} \pm 5\%$, $\pm I_{PM}$ measuring range, DC or AC primary current
Secondary nominal current rms	I_{SN}	mA		50		at 100 At
Supply voltage	V_C	V	± 11.4		± 15.75	
Current consumption	I_C	mA		$10 + I_S$	$12 + I_S$	
Electrical offset current	I_{OE}	μA	-150	0	+150	$V_C = \text{full range}$
Magnetic offset current	I_{OM}	μA		31	65	after a cycle to 50 A
				41	70	after a cycle to 100 A
				100	230	after a cycle to 300 A
				120	250	after a cycle to 500 A
Temperature variation of I_O	I_{OT}	μA	-200		200	$0^\circ\text{C} .. +70^\circ\text{C}$, $V_C = \text{full range}$
			-330		330	$-25^\circ\text{C} .. +85^\circ\text{C}$, $V_C = \text{full range}$
			-500		500	* $-40^\circ\text{C} .. +85^\circ\text{C}$, $V_C = \text{full range}$
Sensitivity	G	mA/At		0.5		
Primary turns	N_P		1		3	
Sensitivity error	e_G	%	-0.47		0.47	$\pm 100\text{ A range}$
Linearity error	e_L	% of range		0.1	0.28	$\pm 50\text{ A range}$
				0.06	0.14	$\pm 100\text{ A range}$
				0.11	0.32	$\pm 100\text{ A range}$, low speed 1 turn PCB design
Overall accuracy	X_G	%	-0.91		0.91	$= I_{OE} + e_G + e_L$
Reaction time	t_{ra}	μs		0.1		high and low speed PCB designs, $di_p/dt = 100\text{ A}/\mu\text{s}$
di/dt accurately followed	di/dt	A/ μs		> 100		
Output current noise	I_{no}	μA_{rms}		0.17		$0.1\text{ Hz} < f < 49\text{ Hz}$, $I_p = 0$
				0.17		$51\text{ Hz} < f < 1\text{ kHz}$, $I_p = 0$
				0.11		$1\text{ kHz} < f < 100\text{ kHz}$, $I_p = 0$
Secondary coil resistance	R_S	Ω		60		

Electrical data (continued)

	Symbol	Unit	N _P	High speed PCB design	Low speed PCB design	Conditions
Response time to 90 % of I _{PN} step (typical)	t _r	μs	1 turn	0.1	12	di _p /dt = 100 A/μs
			2 turns	0.1	0.2	
			3 turns	0.1	0.2	
Frequency bandwidth (typical)	BW	kHz	1 turn	> 300	12.2	I _p = 25 A, -1 dB
				> 300	146	I _p = 25 A, -3 dB
Frequency bandwidth (typical)	BW	kHz	2 turns	> 300	60	I _p = 12.5 A, -1 dB
				> 300	> 300	I _p = 12.5 A, -3 dB
Frequency bandwidth (typical)	BW	kHz	3 turns	> 300	50	I _p = 8.3 A, -1 dB
				> 300	> 300	I _p = 8.3 A, -3 dB

Absolute maximum ratings

	Symbol	Unit	Conditions
Primary AC current rms (3 primary jumpers in parallel)	I _{PN}	A	100 A up to T _A = 70°C. Linear derating to 70 A at 85°C. See figure 2
Primary continuous direct current (3 primary jumpers in parallel)	I _{PN DC}	A	100 A up to T _A = 50°C. Linear derating to 50 A at 85°C. See figure 2
Primary DC or rms current (each jumper)		A	above value divided by 3
Maximum supply voltage (not operating)	V _C	V	± 20
Minimum measuring resistance	R _{M mini}	Ω	See measuring resistance in "Electrical data" table
Maximum busbar temperature (jumper)		°C	100
Ambient operating temperature	T _A	°C	- 40 .. + 85
Ambient storage temperature	T _S	°C	- 40 .. + 90

Stresses above these ratings may cause permanent damage. Exposure to absolute maximum ratings for extended periods may degrade reliability.

Isolation characteristics

	Symbol	Unit	Value
Rms voltage for AC isolation test, 50 Hz, 1 min, between primary and secondary	V_d	kV	3.5
Impulse withstand voltage 1.2/50 μ s	\hat{V}_w	kV	8
Partial discharge extinction voltage rms @ 10pC	V_e	kV	> 1.3
Creepage distance	dCp	mm	8
Clearance distance	dCl	mm	8
Comparative Tracking Index	CTI	V	600

Isolation application example

The transducer can be used according to EN 50178 and IEC 61010-1 standards under following conditions (for example):

- Rated isolation voltage: 600 V
- Reinforced isolation
- Over voltage category OV III
- Pollution degree PD2
- Non-uniform field

The creepage distance and clearance of the transducer mounted on a PCB are greater than 8 mm only if the primary circuit tracks stay out of the shaded area shown below:

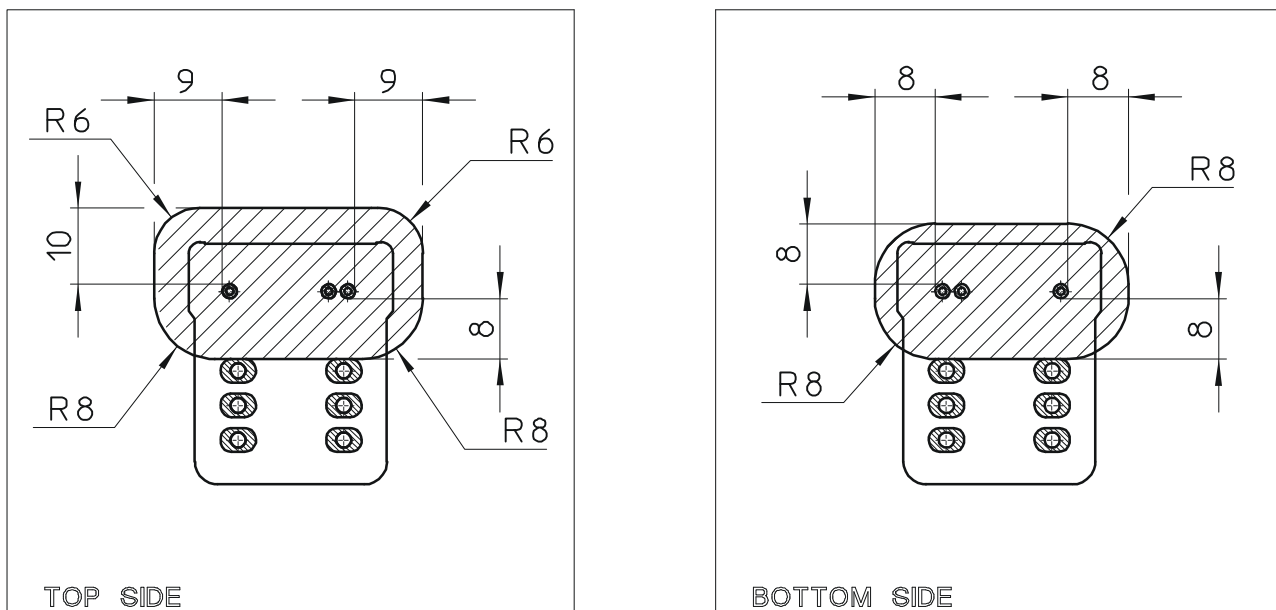


Figure 1: zone not permitted for primary tracks (to guarantee rated creepage and clearance)

Typical performance characteristics

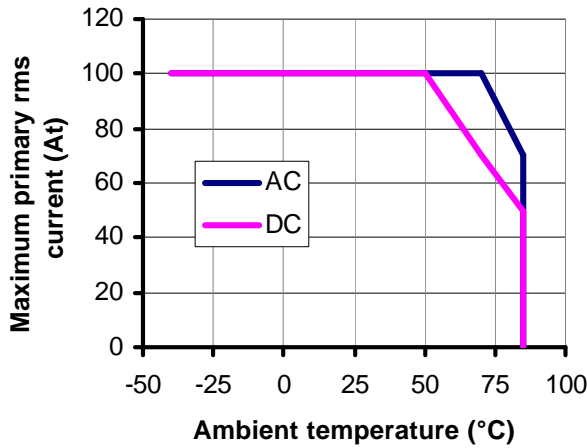


Figure 2: Current derating

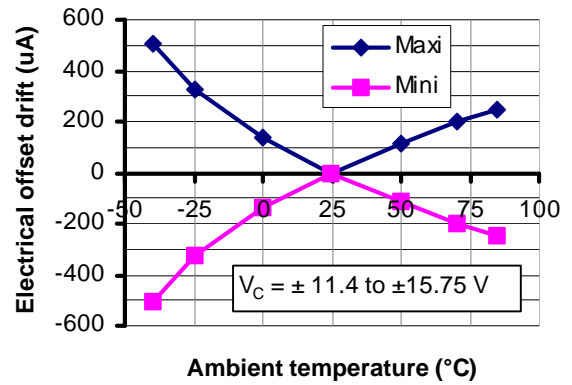


Figure 3: Electrical offset drift

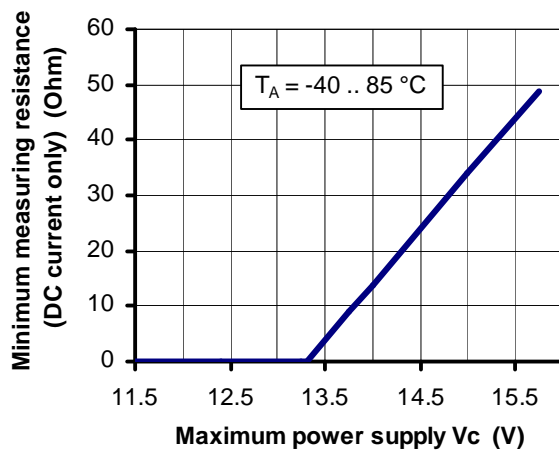


Figure 4: Minimum measuring resistance (DC)

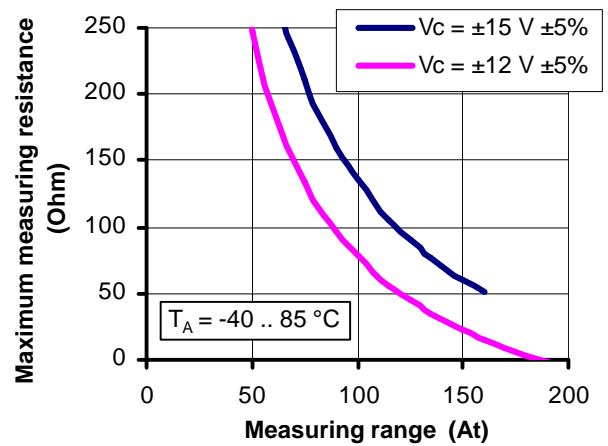


Figure 5: Maximum measuring resistance

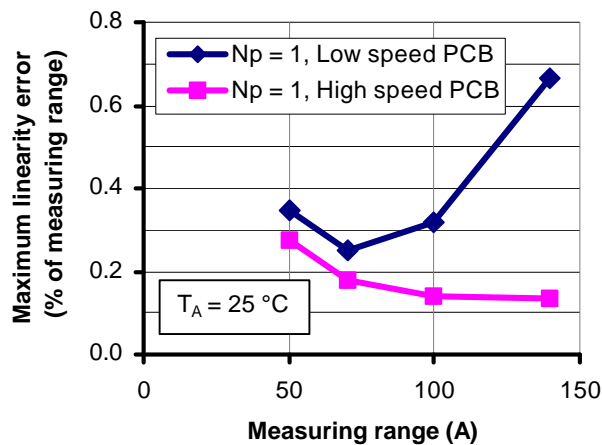


Figure 6: Linearity error

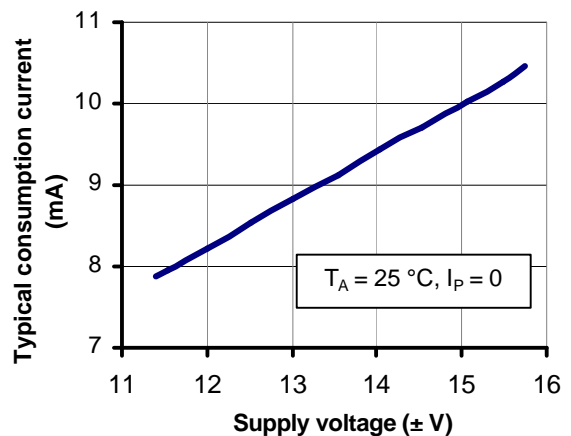


Figure 7: Consumption current

Typical performance characteristics (continued)

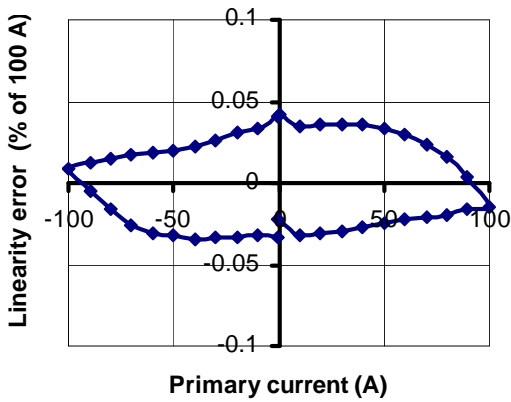


Figure 8: Typical linearity error for high speed 1 turn PCB design

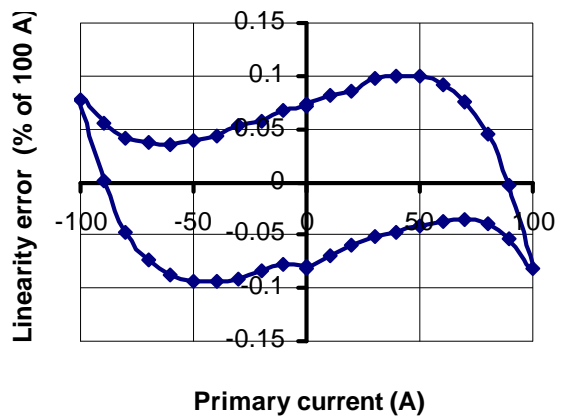


Figure 9: Typical linearity error for low speed 1 turn PCB design

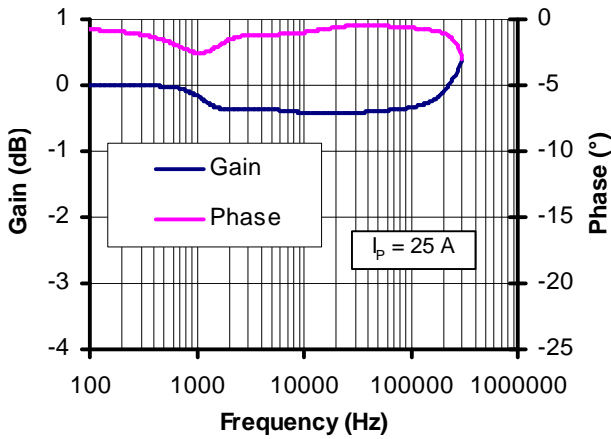


Figure 10: Typical frequency response (high speed 1 turn PCB design) ($I_p = 25 A$)

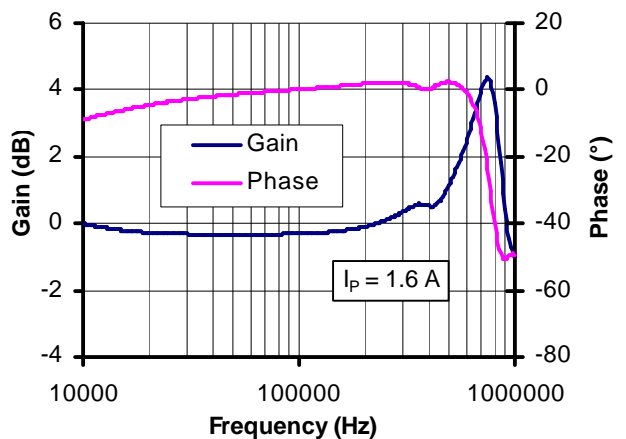


Figure 11: Typical frequency response (high speed 1 turn PCB design) ($I_p = 1.6 A$)

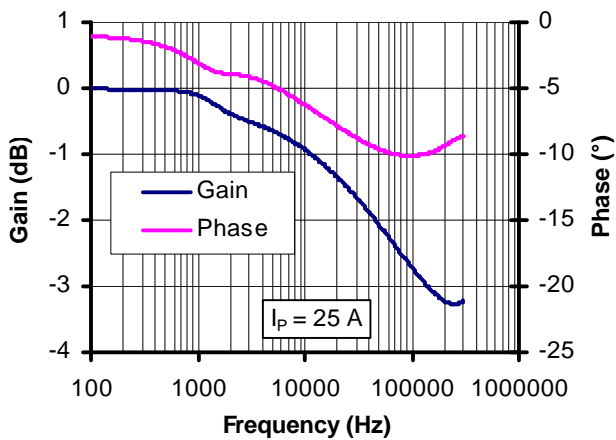


Figure 12: Typical frequency response (low speed 1 turn PCB design) ($I_p = 25 A$)

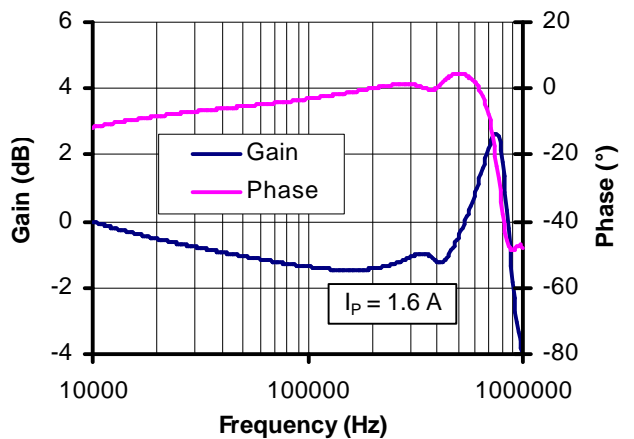


Figure 13: Typical frequency response (low speed 1 turn PCB design) ($I_p = 1.6 A$)

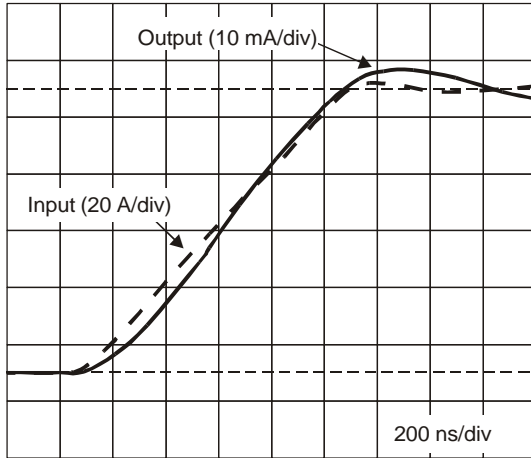
Typical performance characteristics (continued)


Figure 14: Typical di/dt follow-up
(high speed 1 turn PCB design)

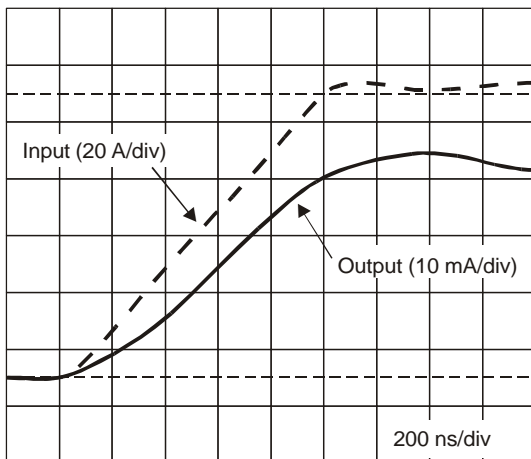


Figure 15: Typical di/dt follow-up
(low speed 1 turn PCB design)

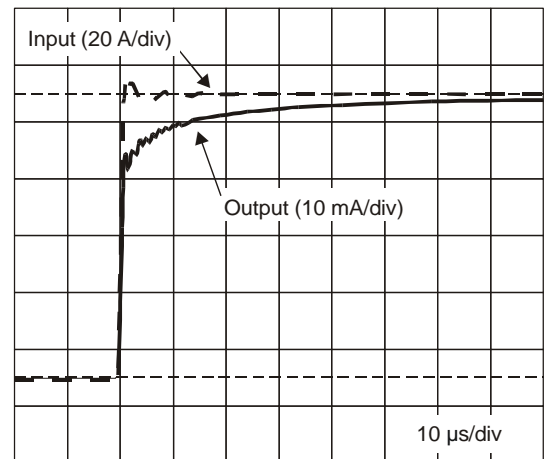


Figure 16: Typical di/dt follow-up
(low speed 1 turn PCB design)

Performance parameters definition

The schematic used to measure all electrical parameters is:
 $C_1 = C_2 = 100 \text{ nF}$, $R_M = 50 \text{ } \Omega$ unless otherwise noted):

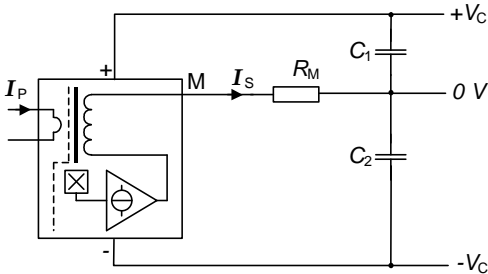


Figure 17 : standard characterization schematics

Ampere-turns and amperes

The LAX transducer is sensitive to the primary current linkage Θ_p (also called ampere-turns).

$$\Theta_p = N_p I_p \text{ (At)}$$

With N_p the number of primary turn (1, 2 or 3 depending on the connection of the primary jumpers)

Warning : As most LAX user will use it with only one single primary turn ($N_p = 1$), most of this datasheet is written with primary currents instead of current linkages. The unit is kept as ampere-turn (At) to make clear that ampere-turns are meant.

Transducer simplified model

The static model of the transducer at temperature T_A is:

$$I_s = G \Theta_p + \text{error}$$

In which $\text{error} = I_{OE} + I_{OT}(T_A) + e_G \Theta_p + e_L(\Theta_{Pmaxi}) \Theta_{Pmaxi}$

- With :
- $\Theta_p = N_p I_p$: the input ampere-turns (At)
Please read above warning.
 - Θ_{Pmaxi} : the maxi input ampere-turns that have been applied to the transducer (At)
 - I_s : the secondary current (A)
 - T_A : the ambient temperature ($^{\circ}\text{C}$)
 - I_{OE} : the electrical offset current (A)
 - $I_{OT}(T_A)$: the temperature variation of I_o at temperature T_A (A)
 - G : the sensitivity of the transducer (A/At)
 - e_G : the sensitivity error
 - $e_L(\Theta_{Pmaxi})$: the linearity error for Θ_{Pmaxi}

This model is valid for primary ampere-turns Θ_p between $-\Theta_{Pmaxi}$ and $+\Theta_{Pmaxi}$ only.

At zero input current, the model for the offset is reduced to:

$$I_s = I_{OE} + I_{OT}(T_A) + I_{OM}(\Theta_{Pmaxi})$$

In which $I_{OM}(\Theta_{Pmaxi})$ is the magnetic offset current due to the maximum input ampere-turns that have been applied to the transducer.

Sensitivity and linearity

To measure sensitivity and linearity, the primary current (DC) is cycled from 0 to I_p , then to $-I_p$ and back to 0 (equally spaced $I_p/10$ steps).

The sensitivity G is defined as the slope of the linear regression line for a cycle between $\pm I_{PN}$.

The linearity error e_L is the maximum positive or negative difference between the measured points and the linear regression line, expressed in % of the maximum measured value.

Magnetic offset

The magnetic offset current I_{OM} is the consequence of a current on the primary side ("memory effect" of the transducer's ferromagnetic parts). It is included in the linearity figure but can be measured individually.

It is measured using the following primary current cycle.

I_{OM} depends on the current value I_{P1} .

$$I_{OM} = \frac{I_s(t_1) - I_s(t_2)}{2}$$

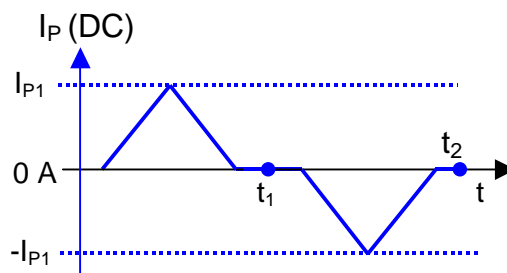


Figure 18: current cycle used to measure magnetic and electrical offset (transducer supplied)

Performance parameters definition (continued)

Electrical offset

The electrical offset current I_{OE} can either be measured when the ferro-magnetic parts of the transducer are:

- completely demagnetized, which is difficult to realize, or
- in a known magnetization state, like in the current cycle shown above.

Using the current cycle shown in figure 18, the electrical offset is:

$$I_{OE} = \frac{Is(t_1) + Is(t_2)}{2}$$

The temperature variation I_{OT} of the electrical offset current I_{OE} is the variation of the electrical offset from 25°C to the considered temperature:

$$I_{OT}(T) = I_{OE}(T) - I_{OE}(25^\circ C)$$

Note: the transducer has to be demagnetized prior to the application of the current cycle (for example with a demagnetization tunnel).

Overall accuracy

The overall accuracy at 25°C X_G is the error in the $-I_{PN} \dots + I_{PN}$ range, relative to the rated value I_{PN} .

It includes:

- the electrical offset I_{OE}
- the sensitivity error e_G
- the linearity error e_L (to I_{PN})

The magnetic offset is part of the overall accuracy. It is taken into account in the linearity error figure provided the transducer has not been magnetized by a current higher than I_{PN} .

Response and reaction times

The response time t_r and the reaction time t_{ra} are shown in the next figure.

Both depend on the primary current di/dt . They are measured at nominal ampere-turns.

The "di/dt accurately followed" mentioned in the electrical data table is defined as the di/dt of the primary current for which the response time is equal to 1 μs .

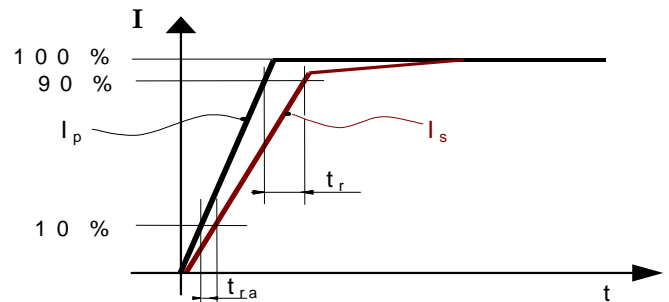
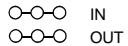
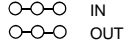
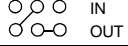
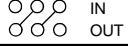
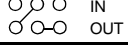
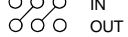


Figure 19: response time t_r and reaction time t_{ra}

Application data

The LAX 100-NP has been designed to be used at nominal currents from 16 to 100 A. The 3 primary jumpers allow the adaptation of the number of primary turns N_P to the application so as to achieve the best compromise between nominal current, measuring range and secondary current:

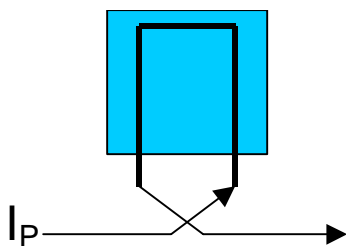
Primary nominal current rms I_{PN} (A)	Number of primary turns N_P	Secondary nominal current rms I_{SN} (mA)	Primary current, measuring range I_{PM} (A)	Primary coil resistance @ 20°C R_P ($\mu\Omega$)	Primary insertion inductance L_P (nH)	Connections (see PCB layout)
100	1	50	160	90	15	 IN OUT
50	1	25	160	90	15	 IN OUT
33.3	2	33.3	80	400	60	 IN OUT
33.3	3	50	53	800	136	 IN OUT
25	2	25	75	400	60	 IN OUT
16.7	3	25	50	800	136	 IN OUT

See also the paragraph "performance parameters definition: transducer simplified model" for more details about ampere-turns and output current.

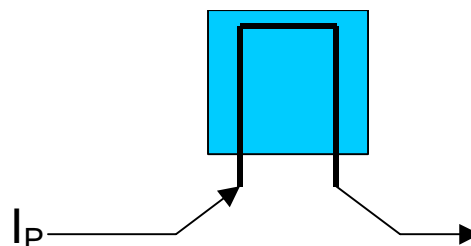
High and low speed PCB designs

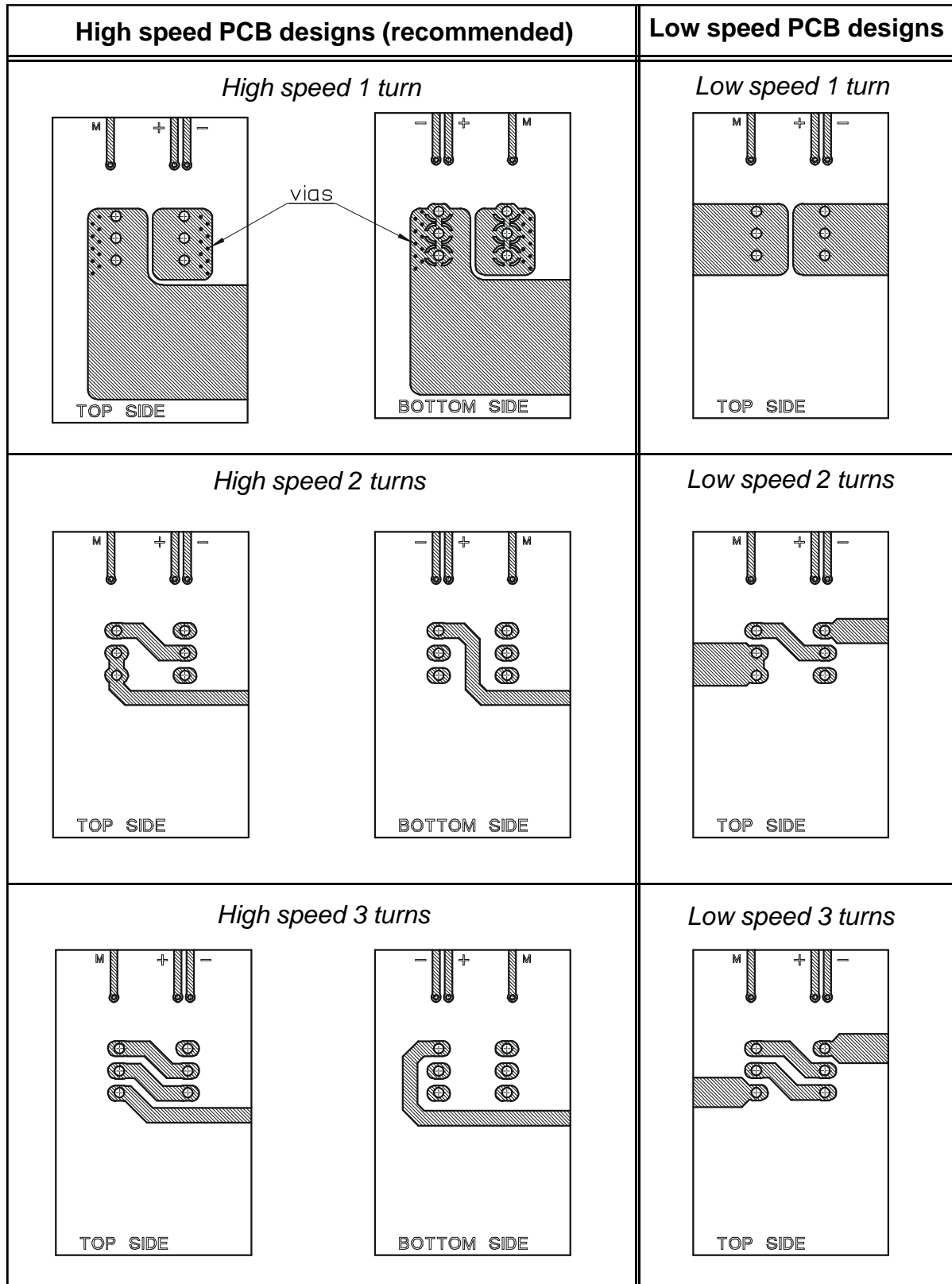
The PCB design is very important to achieve good linearity and frequency response with the LAX 100-NP. High speed designs are best for accuracy, high frequency response and low response times.

High speed design

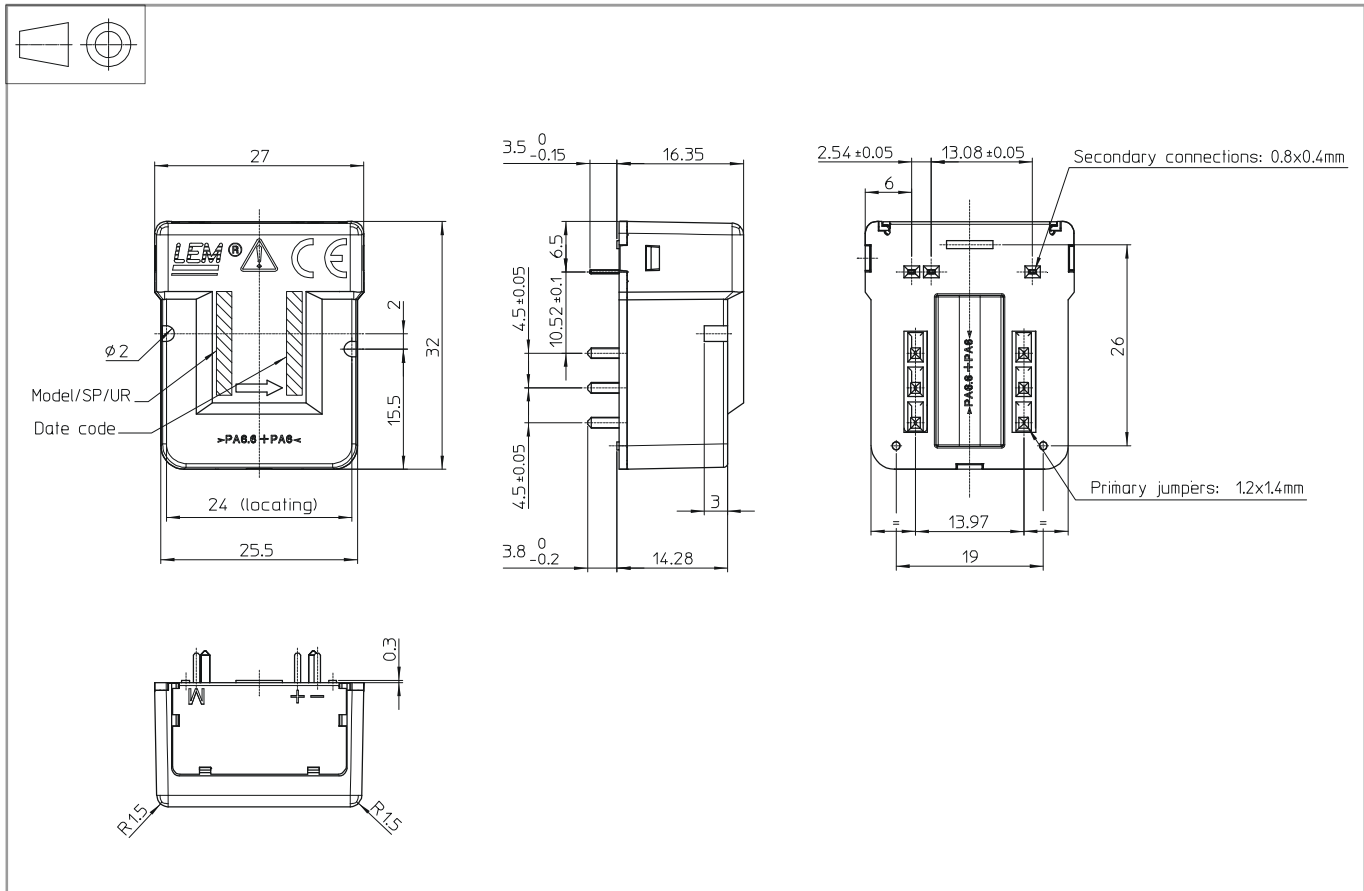


Low speed design



High and low speed PCB designs


Dimensions LAX 100-NP (in mm. General linear tolerance ± 0.15 mm)



Assembly on PCB

- Recommended PCB hole diameter 2 mm (0/+0.1) for primary pins
1 mm (0/+0.1) for secondary pins
- Maximum PCB thickness 2.4 mm
- Solder temperature maximum 270°C for 15 s (wave soldering)
- No-clean process only

Remarks

- I_s is positive (sourcing) when I_p flows in the direction of the arrow
- Mass: 20 g

Safety



This transducer must be used in electric/electronic equipment with respect to applicable standards and safety requirements in accordance with the following manufacturer's operating instructions.



Caution, risk of electrical shock

When operating the transducer, certain parts of the module can carry hazardous voltage (eg. primary busbar, power supply). Ignoring this warning can lead to injury and/or cause serious damage. This transducer is a built-in device, whose conducting parts must be inaccessible after installation. A protective housing or additional shield could be used. Main supply must be able to be disconnected.