

## FSUSB22 Low Power 2 Port Hi-Speed USB 2.0 (480Mbps) Switch

### General Description

FSUSB22 is a low power high bandwidth switch specially designed for applications of the switching of high speed USB 2.0 signals in handset and consumer applications such as cell phone, digital camera, and notebook with hubs or controllers of limited USB I/O. The wide bandwidth (750MHz) of this switch allows signals to pass with minimum edge and phase distortion. Superior channel-to-channel crosstalk results in minimal interference. It is compatible with USB2.0 Hi-Speed standard.

### Features

- -40dB OFF Isolation at 250MHz
- -40dB non-adjacent channel crosstalk at 250MHz
- 4.5Ω typical On Resistance ( $R_{ON}$ )
- -3dB bandwidth: 750MHz
- Low power consumption (1uA max)
- Control input: TTL compatible
- Bidirectional operation
- USB Hi-Speed and Full Speed signaling capability

### Applications

- Cell phone, PDA, digital camera, and notebook

### Ordering Code:

Order Number	Package Number	Package Description
FSUSB22BQX	MLP016E	16-Terminal Depopulated Quad Very-Thin Flat Pack No Leads (DQFN), JEDEC MO-241, 2.5 x 3.5mm
FSUSB22QSC	MQA16	16-Lead Quarter Size Outline Package (QSOP), JEDEC MO-137, 0.150" Wide
FSUSB22QSCX_NL (Note 1)	MQA16	Pb-Free 16-Lead Quarter Size Outline Package (QSOP), JEDEC MO-137, 0.150" Wide
FSUSB22MTC	MTC16	16-Lead Thin Shrink Small Outline Package (TSSOP), JEDEC MO-153, 4.4mm Wide
FSUSB22MTCX_NL (Note 1)	MTC16	Pb-Free 16-Lead Thin Shrink Small Outline Package (TSSOP), JEDEC MO-153, 4.4mm Wide

Devices also available in Tape and Reel. Specify by appending suffix letter "X" to the ordering code.  
Pb-Free package per JEDEC J-STD-020B.

**Note 1:** "\_NL" indicates Pb-Free package (per JEDEC J-STD-020B). Device available in Tape and Reel only.

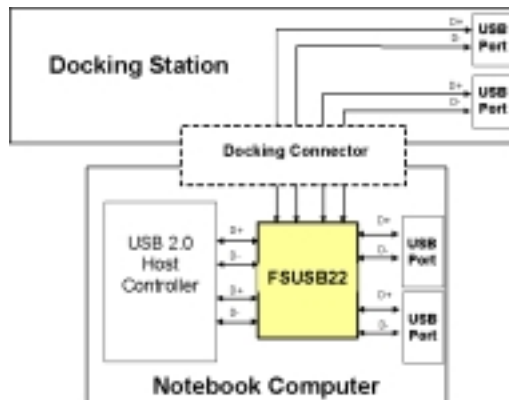

**Analog Symbol**

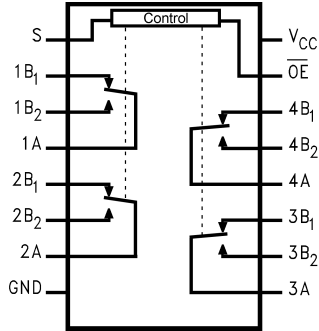

**Connection Diagrams**

Pin Assignments for QSOP and TSSOP

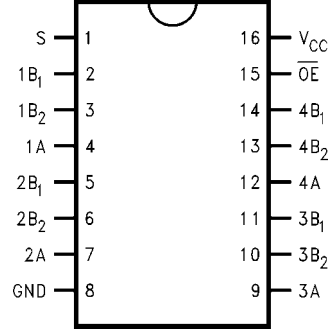

**Pin Descriptions**

Pin Name	Description
$\overline{OE}$	Bus Switch Enable
S	Select Input
A	Bus A
B <sub>1</sub> -B <sub>2</sub>	Bus B

Pad Assignments for DQFN

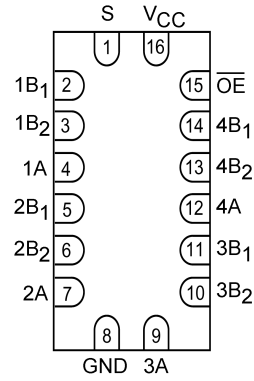

**Truth Table**

s	$\overline{OE}$	Function
X	H	Disconnect
L	L	A = B <sub>1</sub>
H	L	A = B <sub>2</sub>

<b>Absolute Maximum Ratings</b> (Note 2)		<b>Recommended Operating Conditions</b> (Note 4)	
Supply Voltage ( $V_{CC}$ )	-0.5V to +4.6V	Power Supply Operating ( $V_{CC}$ )	3.0V to 3.6V
DC Switch Voltage ( $V_S$ )	-0.5V to $V_{CC} + 0.05V$	Input Voltage ( $V_{IN}$ )	0V to $V_{CC}$
DC Input Voltage ( $V_{IN}$ ) (Note 3)	-0.5V to +4.6V	Output Voltage ( $V_{OUT}$ )	0V to $V_{CC}$
DC Input Diode Current ( $I_{IK}$ ) $V_{IN} < 0V$	-50 mA	Input Rise and Fall Time ( $t_r, t_f$ )	
DC Output ( $I_{OUT}$ ) Sink Current	128 mA	Switch Control Input	0 ns/V to 5 ns/V
DC $V_{CC}/GND$ Current ( $I_{CC}/I_{GND}$ )	$\pm 100$ mA	Switch I/O	0 ns/V to DC
Storage Temperature Range ( $T_{STG}$ )	-65°C to +150 °C	Free Air Operating Temperature ( $T_A$ )	-40 °C to +85 °C
ESD			
Human Body Model	4kV		

**Note 2:** The Absolute Maximum Ratings are those values beyond which the safety of the device cannot be guaranteed. The device should not be operated at these limits. The parametric values defined in the Electrical Characteristics tables are not guaranteed at the absolute maximum rating. The Recommended Operating Conditions tables will define the conditions for actual device operation.

**Note 3:** The input and output negative voltage ratings may be exceeded if the input and output diode current ratings are observed.

**Note 4:** Unused control inputs must be held HIGH or LOW. They may not float.

### DC Electrical Characteristics

Symbol	Parameter	$V_{CC}$ (V)	$T_A = -40\text{ }^\circ\text{C to } +85\text{ }^\circ\text{C}$			Units	Conditions
			Min	Typ (Note 5)	Max		
$V_{IK}$	Clamp Diode Voltage	3.0			-1.2	V	$I_{IN} = -18\text{ mA}$
$V_{IH}$	HIGH Level Input Voltage	3.0 - 3.6	2.0			V	
$V_{IL}$	LOW Level Input Voltage	3.0 - 3.6			0.8	V	
$I_I$	Input Leakage Current	3.6			$\pm 1.0$	$\mu\text{A}$	$0 \leq V_{IN} \leq 3.6V$
$I_{OFF}$	OFF-STATE Leakage Current	3.6			$\pm 1.0$	$\mu\text{A}$	$0 \leq A, B \leq V_{CC}$
$R_{ON}$	Switch On Resistance (Note 6)	3.0		5.0	7.0	$\Omega$	$V_{IN} = 0.8V$ $I_{ON} = 8\text{ mA}$
		3.0		4.5	6.5	$\Omega$	$V_{IN} = 3.0V$ $I_{ON} = 8\text{ mA}$
$\Delta R_{ON}$	Delta $R_{ON}$	3.0		0.3		$\Omega$	$V_{IN} = 0.8V, V_{IN} = 0V - 1.5V, I_{ON} = 8\text{ mA}$
$R_{FLAT(ON)}$	On Resistance Flatness (Note 7)	3.0		1.0		$\Omega$	$I_{OUT} = 8\text{ mA}$
$I_{CC}$	Quiescent Supply Current	3.6			1.0	$\mu\text{A}$	$V_{IN} = V_{CC}$ or GND, $I_{OUT} = 0$

**Note 5:** Typical values are at  $V_{CC} = 3.0V$  and  $T_A = +25^\circ\text{C}$

**Note 6:** Measured by the voltage drop between A and B pins at the indicated current through the switch. On Resistance is determined by the lower of the voltages on the two (A or B) pins.

**Note 7:** Flatness is defined as the difference between the maximum and minimum value On Resistance over the specified range of conditions.

### AC Electrical Characteristics

Symbol	Parameter	V <sub>CC</sub> (V)	T <sub>A</sub> = -40°C to +85°C			Units	Conditions	Figure Number
			Min	Typ (Note 8)	Max			
t <sub>ON</sub>	Turn ON Time S-to-Bus B	3.0 to 3.6		4.5	6.0	ns		Figures 5, 6
t <sub>OFF</sub>	Turn OFF Time S-to-Bus B	3.0 to 3.6		2.5	4.0	ns		Figures 5, 6
t <sub>PD</sub>	Propagation Delay	3.0 to 3.6		0.25		ns	C <sub>L</sub> = 10 pF	Figure 10
O <sub>IRR</sub>	Non-Adjacent OFF-Isolation	3.0 to 3.6		-30.0		dB	f = 250MHz, R <sub>L</sub> = 50Ω	Figure 7
X <sub>TALK</sub>	Non-Adjacent Channel Crosstalk	3.0 to 3.6		-38.0		dB	R <sub>L</sub> = 50Ω, f = 250MHz	Figure 8
BW	-3dB Bandwidth	3.0 to 3.6		750		MHz	R <sub>L</sub> = 50Ω	Figure 9

Note 8: Typical values are at V<sub>CC</sub> = 3.3V and T<sub>A</sub> = +25°C

### USB Related AC Electrical Characteristics (Note 9)

Symbol	Parameter	V <sub>CC</sub> (V)	T <sub>A</sub> = -40°C to +85°C			Units	Conditions	Figure Number
			Min	Typ	Max			
t <sub>SK(O)</sub>	Channel-to-Channel Skew	3.0 to 3.6		0.051		ns	C <sub>L</sub> = 10 pF	Figures 10, 11
t <sub>SK(P)</sub>	Skew of Opposite Transition of the Same Output	3.0 to 3.6		0.020		ns	C <sub>L</sub> = 10 pF	Figures 10, 11
T <sub>J</sub>	Total Jitter	3.0 to 3.6		0.210		ns	R <sub>L</sub> = 50Ω, C <sub>L</sub> = 10 pF t <sub>R</sub> = t <sub>F</sub> = 750ps at 480 Mbps	

Note 9: Typical values are at V<sub>CC</sub> = 3.3V and T<sub>A</sub> = +25°C

### Capacitance (Note 10)

Symbol	Parameter	T <sub>A</sub> = -40°C to +85°C		Units	Conditions
		Typ			
C <sub>IN</sub>	Control Pin Input Capacitance	2.5		pF	V <sub>CC</sub> = 0V
C <sub>ON</sub>	A/B ON Capacitance	12.0		pF	V <sub>CC</sub> = 3.3V, OE = 0V
C <sub>OFF</sub>	Port B OFF Capacitance	4.5		pF	V <sub>CC</sub> and OE = 3.3V

Note 10: Typical values are at V<sub>CC</sub> = 3.3V and T<sub>A</sub> = +25°C

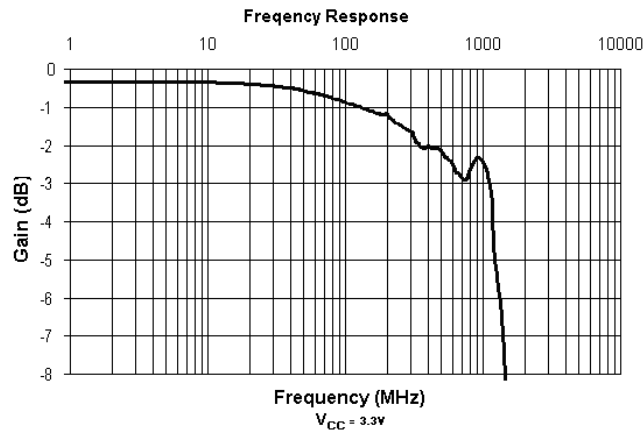

FIGURE 1. Gain vs. Frequency

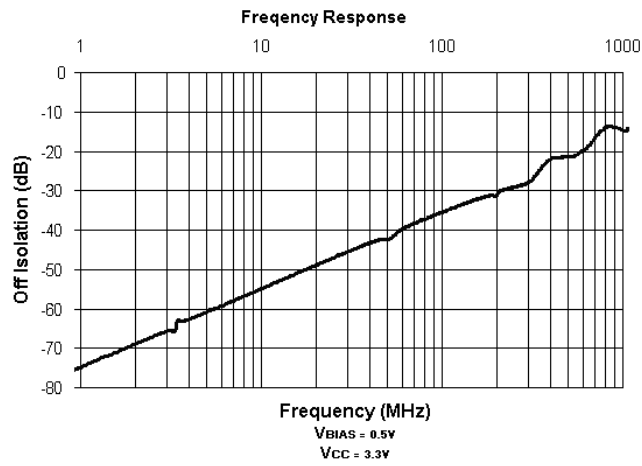

FIGURE 2. OFF Isolation

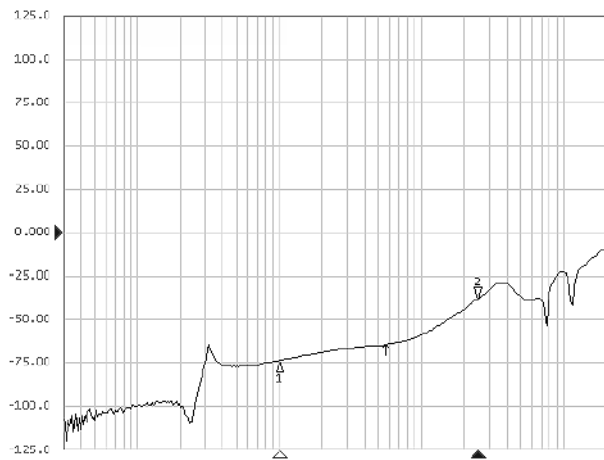

FIGURE 3. Crosstalk

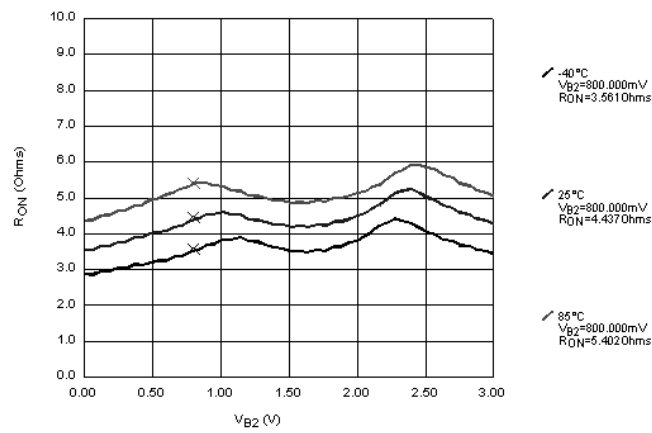
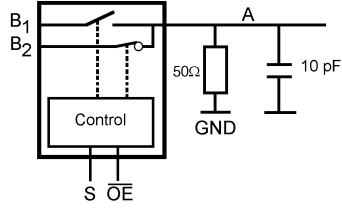

FIGURE 4. RON

## AC Loading and Waveforms



**Note:** Input driven by 50Ω source terminated in 50Ω  
**Note:**  $C_L$  includes load and stray capacitance  
**Note:** Input PRR = 1.0 MHz,  $t_W = 500$  ns

FIGURE 5. AC Test Circuit

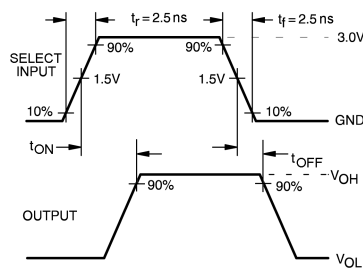

FIGURE 6. AC Waveforms

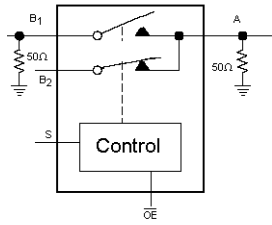

FIGURE 7. OFF Isolation Test

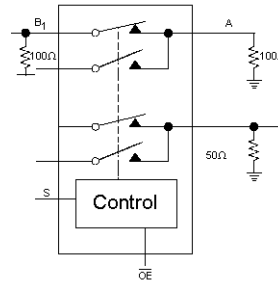

FIGURE 8. Crosstalk Test

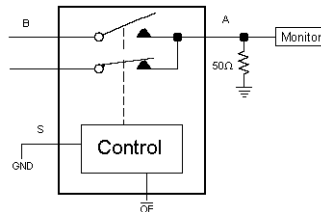

FIGURE 9. Bandwidth Test

AC Loading and Waveforms (Continued)

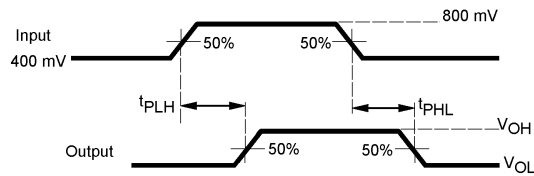
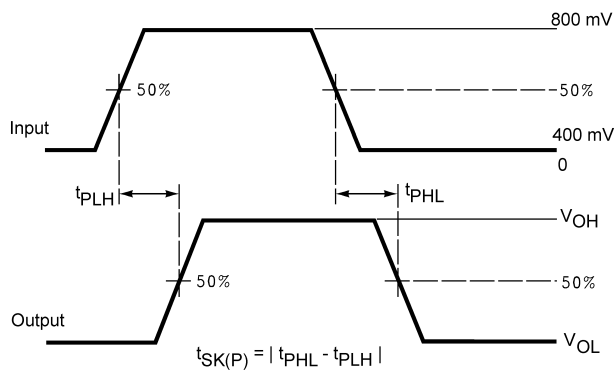
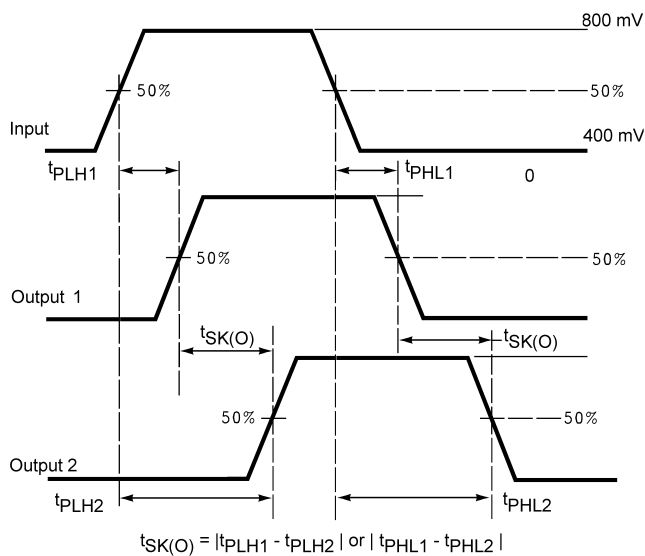

FIGURE 10. Propagation Delay



Pulse Skew  $t_{SK(P)}$



Output Skew  $t_{SK(O)}$

FIGURE 11. Skew Test

## Tape and Reel Specification

### Tape Format for DQFN

Package Designator	Tape Section	Number Cavities	Cavity Status	Cover Tape Status
BQX	Leader (Start End)	125 (typ)	Empty	Sealed
	Carrier	2500/3000	Filled	Sealed
	Trailer (Hub End)	75 (typ)	Empty	Sealed

### TAPE DIMENSIONS inches (millimeters)

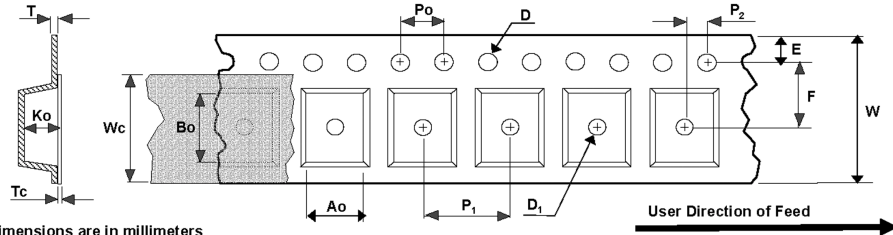

Dimensions are in millimeters

Package	Ao	Bo	D	D <sub>1</sub>	E	F	Ko	P <sub>1</sub>	P <sub>0</sub>	P <sub>2</sub>	T	Tc	W	Wc
	+/-0.10	+/-0.10	+/-0.05	min.	+/-0.1	+/-0.1	+/-0.1	TYP	TYP	+/-0.05	TYP	+/-0.005	+/-0.3	TYP
2 x 2	2.30	2.30	1.55	1.0	1.75	3.5	1.0	8	4	2.0	0.3	0.07	8	5.3
2.5x2.5	2.80	2.80	1.55	1.5	1.75	5.5	0.9	8	4	2.0	0.3	0.07	12	9.3
2.5x3.0	2.80	3.30	1.55	1.5	1.75	5.5	0.9	8	4	2.0	0.3	0.07	12	9.3
2.5x3.5	2.80	3.80	1.55	1.5	1.75	5.5	0.9	8	4	2.0	0.3	0.07	12	9.3
2.5x4.5	2.80	4.80	1.55	1.5	1.75	5.5	0.9	8	4	2.0	0.3	0.07	12	9.3
3.5x4.5	3.80	4.80	1.55	1.5	1.75	5.5	0.9	8	4	2.0	0.3	0.07	12	9.3
2.5x3.0	2.80	3.30	1.55	1.5	1.75	5.5	0.9	8	4	2.0	0.3	0.07	12	9.3
4 x 4	4.35	4.35	1.55	1.5	1.75	5.5	1.1	8	4	2.0	0.3	0.07	12	9.3
5 x 5	5.35	5.35	1.55	1.5	1.75	5.5	1.1	8	4	2.0	0.3	0.07	12	9.3
6 x 6	6.30	6.30	1.55	1.5	1.75	7.5	1.1	12	4	2.0	0.3	0.07	16	13.3

Notes: Ao, Bo, and Ko dimensions are determined with respect to the EIA/Jedec RS-481 rotational and lateral movement requirements (see sketches A, B, and C).

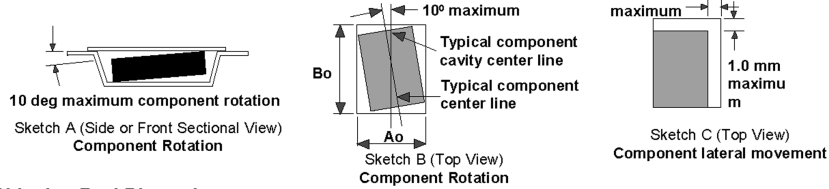

### Shipping Reel Dimension

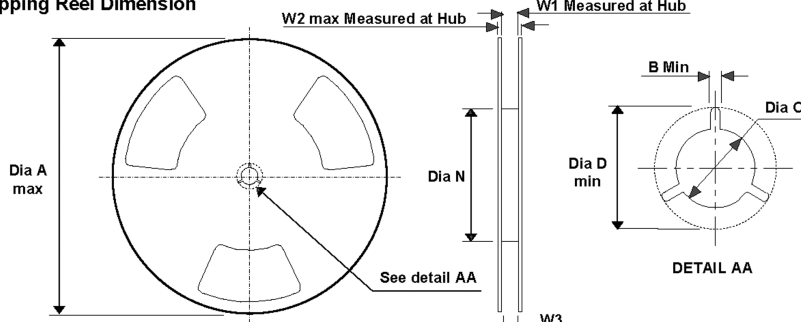

Dimensions are in millimeters

Tape Width	Dia A max	Dim B min	Dia C +/- .2	Dia D min	Dia N min	Dim W1 +2/-0	Dim W2 max	Dim W3 (LSL - USL)
8	330	1.5	13	20.2	178	8.4	14.4	7.9~10.4
12	330	1.5	13	20.2	178	12.4	18.4	11.9~15.4
16	330	1.5	13	20.2	178	16.4	22.4	15.9~19.4



**Physical Dimensions** inches (millimeters) unless otherwise noted

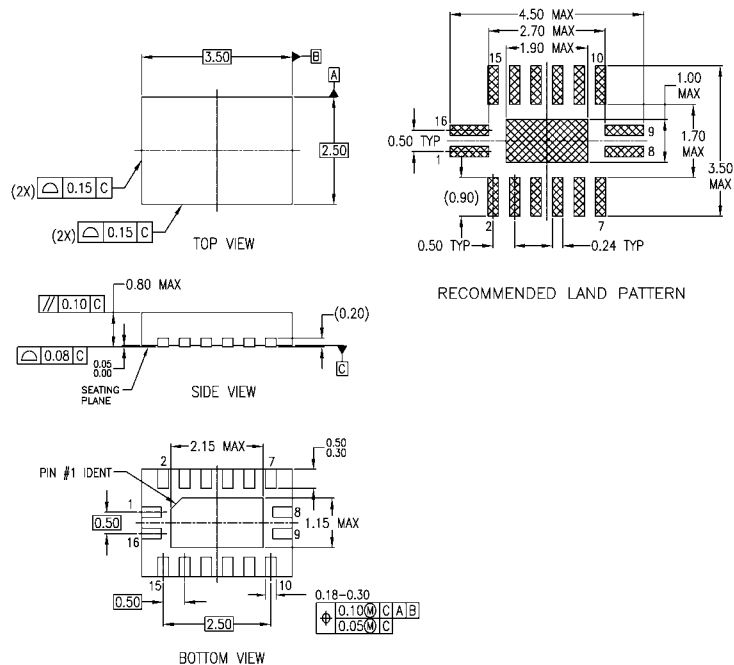

NOTES:

- A. CONFORMS TO JEDEC REGISTRATION MO-241, VARIATION AB
- B. DIMENSIONS ARE IN MILLIMETERS.
- C. DIMENSIONS AND TOLERANCES PER ASME Y14.5M, 1994

MLP016ErevA

**16-Terminal Depopulated Quad Very-Thin Flat Pack No Leads (DQFN), JEDEC MO-241, 2.5 x 3.5mm  
Package Number MLP016E**

**Physical Dimensions** inches (millimeters) unless otherwise noted (Continued)

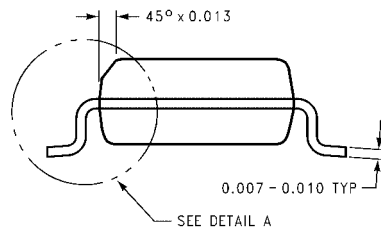
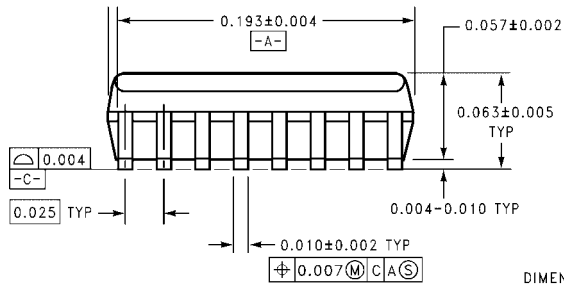
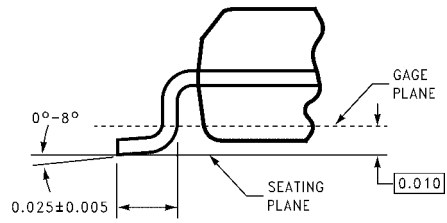
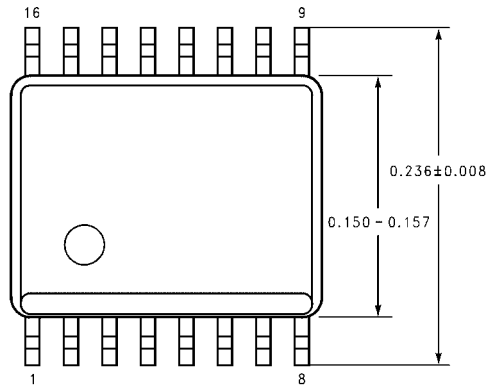

DIMENSIONS ARE IN INCHES

MQA16 (REV A)

**16-Lead Quarter Size Outline Package (QSOP), JEDEC MO-137, 0.150" Wide  
Package Number MQA16**

**Physical Dimensions** inches (millimeters) unless otherwise noted (Continued)

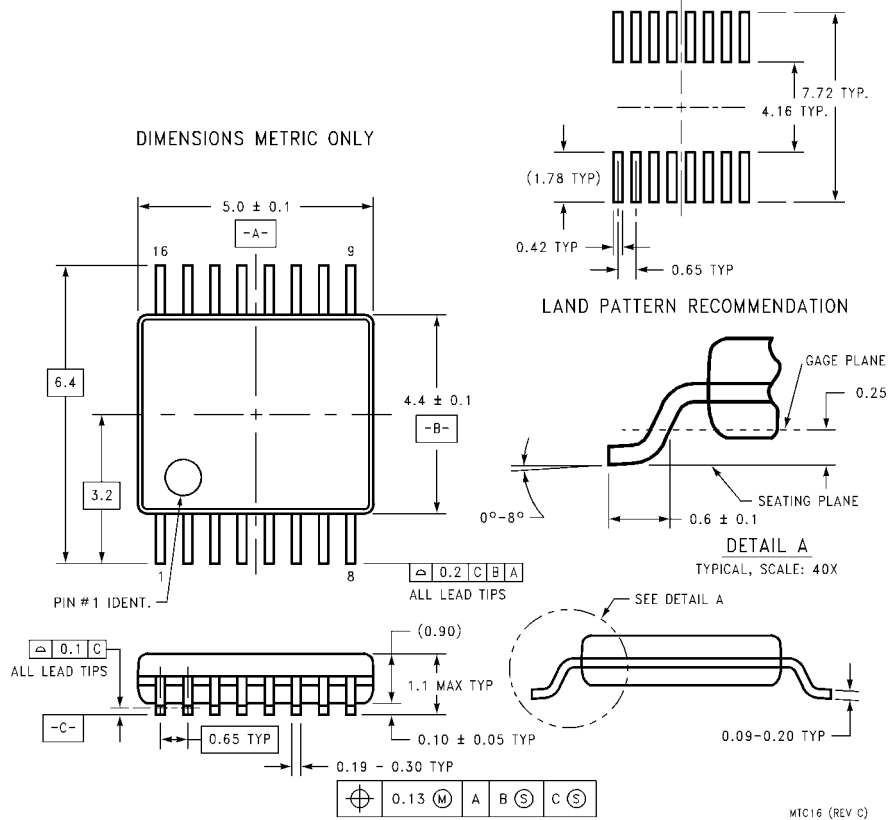

**16-Lead Thin Shrink Small Outline Package (TSSOP), JEDEC MO-153, 4.4mm Wide  
Package Number MTC16**

**Technology Description**

The Fairchild Switch family derives from and embodies Fairchild's proven switch technology used for several years in its 74LVX3L384 (FST3384) bus switch product.

Fairchild does not assume any responsibility for use of any circuitry described, no circuit patent licenses are implied and Fairchild reserves the right at any time without notice to change said circuitry and specifications.

**LIFE SUPPORT POLICY**

FAIRCHILD'S PRODUCTS ARE NOT AUTHORIZED FOR USE AS CRITICAL COMPONENTS IN LIFE SUPPORT DEVICES OR SYSTEMS WITHOUT THE EXPRESS WRITTEN APPROVAL OF THE PRESIDENT OF FAIRCHILD SEMICONDUCTOR CORPORATION. As used herein:

1. Life support devices or systems are devices or systems which, (a) are intended for surgical implant into the body, or (b) support or sustain life, and (c) whose failure to perform when properly used in accordance with instructions for use provided in the labeling, can be reasonably expected to result in a significant injury to the user.
2. A critical component in any component of a life support device or system whose failure to perform can be reasonably expected to cause the failure of the life support device or system, or to affect its safety or effectiveness.

[www.fairchildsemi.com](http://www.fairchildsemi.com)