



8-INPUT UNIVERSAL SHIFT/STORAGE REGISTER WITH COMMON PARALLEL I/O PINS

The MC74F299 is an 8-Bit Universal Shift/Storage Register with 3-state outputs. Four modes of operation are possible: hold (store), shift left, shift right and load data.

The parallel load inputs and flip-flop outputs are multiplexed to reduce the total number of package pins. Separate outputs are provided for flip-flops Q₀ and Q₇ to allow easy cascading. A separate active LOW Master Reset is used to reset the register.

- Common I/O for Reduced Pin Count
- Four Operation Modes: Shift left, Shift Right, Load and Store
- Separate Shift Right Serial Input and Shift Left Serial Input for Easy Cascading
- 3-State Outputs for Bus Oriented Applications
- Input Clamp Diodes Limit High-Speed Termination Effects

CONNECTION DIAGRAM

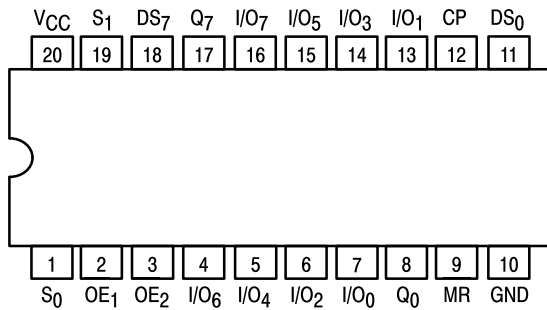

MC74F299

8-INPUT UNIVERSAL SHIFT/STORAGE REGISTER WITH COMMON PARALLEL I/O PINS

FAST™ SCHOTTKY TTL

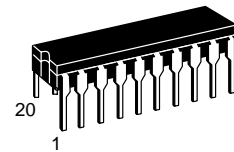

J SUFFIX CERAMIC
CASE 732-03

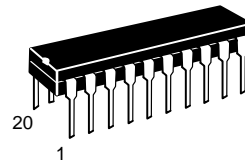

N SUFFIX PLASTIC
CASE 738-03

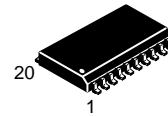

DW SUFFIX SOIC
CASE 751D-03

ORDERING INFORMATION

MC74FXXXJ Ceramic
MC74FXXXN Plastic
MC74FXXXDW SOIC

GUARANTEED OPERATING RANGES

Symbol	Parameter		Min	Typ	Max	Unit
V _{CC}	Supply Voltage	74	4.5	5.0	5.5	V
T _A	Operating Ambient Temperature Range	74	0	25	70	°C
I _{OH}	Output Current — High	74			-1.0/-3.0	mA
I _{OL}	Output Current — Low	74			20/24	mA

MC74F299

FUNCTION TABLE

Inputs				Response
MR	S ₁	S ₀	CP	
L	X	X	X	Asynchronous Reset: Q ₀ –Q ₇ = LOW
H	H	H	↑	Parallel Load: I/O _n Q _n
H	L	H	↑	Shift Right: DS ₀ Q ₀ , Q ₀ Q ₁ , etc.
H	H	L	↑	Shift Left: DS ₇ Q ₇ , Q ₇ Q ₆ , etc.
H	L	L	X	Hold

H = HIGH Voltage Level
 L = LOW Voltage Level
 X = Don't Care
 ↑ = LOW-to-HIGH clock transition.

FUNCTIONAL DESCRIPTION

The MC74F299 is an 8-bit universal shift/storage register with 3-state outputs. Four modes of operation are possible: hold (store), shift left, shift right and load data. The parallel load inputs and flip-flop outputs are multiplexed to reduce the total number of package pins. Additional outputs are provided for flip-flops Q₀ and Q₇ to allow easy serial cascading. A separate active-LOW Master Reset is used to reset the register.

The MC74F299 contains eight edge-triggered D-type flip-flops and the interstage logic necessary to perform synchronous shift left, shift right, parallel load and hold operations. The type of operation is determined by S₀ and S₁, as shown in the Function Table. All flip-flop outputs are brought out through 3-state buffers to separate I/O pins that also serve as data inputs in the parallel load mode. Q₀ and Q₇

are also brought out on other pins for expansion in serial shifting of longer words.

A LOW signal on MR overrides the Select and CP inputs and resets the flip-flops. All other state changes are initiated by the rising edge of the clock. Inputs can change when the clock is in either state provided only that the recommended set-up and hold times, relative to the rising edge of CP, are observed.

A HIGH signal on either OE₁ or OE₂ disables the 3-state buffers and puts the I/O pins in the high impedance state. In this condition the shift, hold, load and reset operations can still occur. The 3-state buffers are also disabled by HIGH signals on both S₀ and S₁ in preparation for a parallel load operation.

DC CHARACTERISTICS OVER OPERATING TEMPERATURE RANGE (Unless otherwise specified)

Symbol	Parameter	Limits			Unit	Test Conditions		
		Min	Typ	Max				
V _{IH}	Input HIGH Voltage	2.0			V	Guaranteed Input HIGH Voltage		
V _{IL}	Input LOW Voltage			0.8	V	Guaranteed Input LOW Voltage		
V _{IK}	Input Clamp Diode Voltage			-1.2	V	V _{CC} = MIN, I _{IN} = -18 mA		
V _{OH}	Output HIGH Voltage	Q ₀ /Q ₇	74	2.5		V	I _{OH} = -1.0 mA	V _{CC} = 4.5 V
			74	2.7				V _{CC} = 4.75 V
		I/O	74	2.7	3.4	V	I _{OH} = -3.0 mA	V _{CC} = 4.75 V
			74	2.4				V _{CC} = 4.5 V
V _{OL}	Output LOW Voltage	Q ₀ /Q ₇			V	I _{OL} = 20 mA	V _{CC} = MIN	
		I/O				I _{OL} = 24 mA		
I _{IH}	Input HIGH Current	Q ₀ /Q ₇			μA	V _{CC} = MAX, V _{IN} = 2.7 V		
		I/O					20	
		Q ₀ /Q ₇			mA	V _{CC} = MAX	V _{IN} = 7.0 V	
		I/O					1.0	V _{IN} = 5.5 V
I _{IL}	Input LOW Current	S ₀ , S ₁			mA	V _{CC} = MAX, V _{IN} = 0.5 V		
		Other Inputs					-1.2	
I _{OZH}	Off-State Output Current, High-Level Voltage Applied				70	μA	V _{CC} = MAX	V _{OUT} = 2.7 V
					1.0			mA
I _{OZL}	Off-State Output Current, Low-Level Voltage Applied				-0.6	mA	V _{CC} = MAX, V _{OUT} = 0.5 V	
I _{OS}	Output Short Circuit Current (Note 2)				-60	mA	V _{CC} = MAX	V _{OUT} = 0 V
I _{CC}	Total Supply Current				-150			OE = HIGH, CP = HIGH

NOTES:

- For conditions shown as MIN or MAX, use appropriate value specified under recommended operating conditions for the applicable device type.
- Not more than one output should be shorted at one time, nor for more than 1 second.

MC74F299

AC ELECTRICAL CHARACTERISTICS

Symbol	Parameter	74F		74F		Unit
		T _A = +25°C V _{CC} = +5.0 V C _L = 50 pF		T _A = 0°C to +70°C V _{CC} = +5.0 V ±10% C _L = 50 pF		
		Min	Max	Min	Max	
f _{MAX}	Maximum Clock Frequency	70		70		MHz
t _{PLH} t _{PHL}	Propagation Delay CP to Q ₀ or Q ₇	3.5 4.5	7.5 8.0	3.5 4.5	8.5 8.5	ns
t _{PLH} t _{PHL}	Propagation Delay CP to I/O _n	3.5 4.0	9.0 9.0	3.5 4.0	10 10	ns
t _{PHL}	Propagation Delay MR to Q ₀ or Q ₇	5.5	9.5	5.5	10.5	ns
t _{PHL}	Propagation Delay MR to I/O _n	5.5	10	5.5	10.5	ns
t _{PZH} t _{PZL}	Output Enable Time to HIGH or LOW Level	3.5 4.0	8.0 10	3.5 4.0	9.0 11	ns
t _{PHZ} t _{PLZ}	Output Disable Time to HIGH or LOW Level	2.0 1.0	7.0 5.5	2.0 1.0	8.0 6.5	ns

AC SETUP REQUIREMENTS

Symbol	Parameter	74F			74F		Unit
		T _A = +25°C V _{CC} = +5.0 V C _L = 50 pF			T _A = 0°C to +70°C V _{CC} = +5.0 V ±10% C _L = 50 pF		
		Min	Typ	Max	Min	Max	
t _{s(H)} t _{s(L)}	Set-Up Time, HIGH or LOW S ₀ or S ₁ to CP	6.5 6.5			7.5 7.5		ns
t _{h(H)} t _{h(L)}	Hold Time, HIGH or LOW S ₀ or S ₁ to CP	0 0			0 0		ns
t _{s(H)} t _{s(L)}	Set-Up Time, HIGH or LOW I/O _n , DS ₀ , DS ₇ to CP	3.5 3.5			4.0 4.0		ns
t _{h(H)} t _{h(L)}	Hold Time, HIGH or LOW I/O _n , DS ₀ , DS ₇ to CP	0 1.0			0 1.0		ns
t _{w(H)} t _{w(L)}	CP Pulse Width, HIGH or LOW	5.0 4.5			5.0 4.5		ns
t _{w(L)}	MR Pulse Width LOW	4.5			4.5		ns
t _{rec}	Recovery Time MR to CP	4.0			4.0		ns

**Case 751D-03 DW Suffix
20-Pin Plastic
SO-20 (WIDE)**

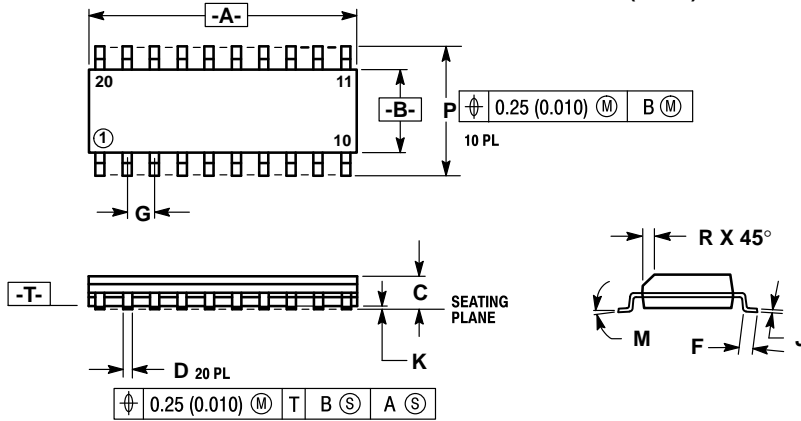

- NOTES:
1. DIMENSIONING AND TOLERANCING PER ANSI Y14.5M, 1982.
 2. CONTROLLING DIMENSION: MILLIMETER.
 3. DIMENSION A AND B DO NOT INCLUDE MOLD PROTRUSION.
 4. MAXIMUM MOLD PROTRUSION 0.15 (0.006) PER SIDE.
 5. 751D-01, AND -02 OBSOLETE, NEW STANDARD 751D-03.

DIM	MILLIMETERS		INCHES	
	MIN	MAX	MIN	MAX
A	12.65	12.95	0.499	0.510
B	7.40	7.60	0.292	0.299
C	2.35	2.65	0.093	0.104
D	0.35	0.49	0.014	0.019
F	0.50	0.90	0.020	0.035
G	1.27 BSC	0.050 BSC		
J	0.25	0.32	0.010	0.012
K	0.10	0.25	0.004	0.009
M	0°	7°	0°	7°
P	10.05	10.55	0.395	0.415
R	0.25	0.75	0.010	0.029

**Case 732-03 J Suffix
20-Pin Ceramic Dual In-Line**

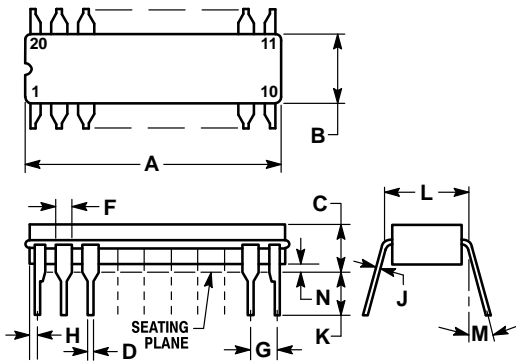

- NOTES:
1. LEADS WITHIN 0.25 mm (0.010) DIA., TRUE POSITION AT SEATING PLANE, AT MAXIMUM MATERIAL CONDITION.
 2. DIM L TO CENTER OF LEADS WHEN FORMED PARALLEL.
 3. DIM A AND B INCLUDES MENISCUS.

DIM	MILLIMETERS		INCHES	
	MIN	MAX	MIN	MAX
A	23.88	25.15	0.940	0.990
B	6.60	7.49	0.260	0.295
C	3.81	5.08	0.150	0.200
D	0.38	0.56	0.015	0.022
F	1.40	1.65	0.055	0.065
G	2.54 BSC	0.100 BSC		
H	0.51	1.27	0.020	0.050
J	0.20	0.30	0.008	0.012
K	3.18	4.06	0.125	0.160
L	7.62 BSC	0.300 BSC		
M	0°	15°	0°	15°
N	0.25	1.02	0.010	0.040

**Case 738-03 N Suffix
20-Pin Plastic**

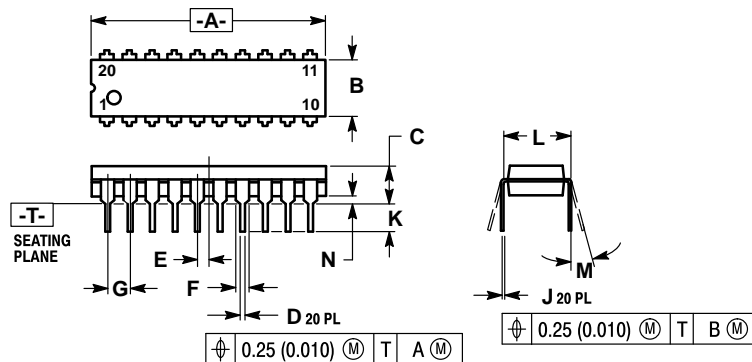

- NOTES:
1. DIMENSIONING AND TOLERANCING PER ANSI Y14.5M, 1982.
 2. CONTROLLING DIMENSION: INCH.
 3. DIMENSION "L" TO CENTER OF LEAD WHEN FORMED PARALLEL.
 4. DIMENSION "B" DOES NOT INCLUDE MOLD FLASH.
 5. 738-02 OBSOLETE, NEW STANDARD 738-03.

DIM	MILLIMETERS		INCHES	
	MIN	MAX	MIN	MAX
A	25.66	27.17	1.010	1.070
B	6.10	6.60	0.240	0.260
C	3.81	4.57	0.150	0.180
D	0.39	0.55	0.015	0.022
E	1.27 BSC	0.050 BSC		
F	1.27	1.77	0.050	0.070
G	2.54 BSC	0.100 BSC		
J	0.21	0.38	0.008	0.015
K	2.80	3.55	0.110	0.140
L	7.62 BSC	0.300 BSC		
M	0°	15°	0°	15°
N	0.51	1.01	0.020	0.040

Motorola reserves the right to make changes without further notice to any products herein. Motorola makes no warranty, representation or guarantee regarding the suitability of its products for any particular purpose, nor does Motorola assume any liability arising out of the application or use of any product or circuit, and specifically disclaims any and all liability, including without limitation consequential or incidental damages. "Typical" parameters can and do vary in different applications. All operating parameters, including "Typicals" must be validated for each customer application by customer's technical experts. Motorola does not convey any license under its patent rights nor the rights of others. Motorola products are not designed, intended, or authorized for use as components in systems intended for surgical implant into the body, or other applications intended to support or sustain life, or for any other application in which the failure of the Motorola product could create a situation where personal injury or death may occur. Should Buyer purchase or use Motorola products for any such unintended or unauthorized application, Buyer shall indemnify and hold Motorola and its officers, employees, subsidiaries, affiliates, and distributors harmless against all claims, costs, damages, and expenses, and reasonable attorney fees arising out of, directly or indirectly, any claim of personal injury or death associated with such unintended or unauthorized use, even if such claim alleges that Motorola was negligent regarding the design or manufacture of the part. Motorola and  are registered trademarks of Motorola, Inc. Motorola, Inc. is an Equal Opportunity/Affirmative Action Employer.

Literature Distribution Centers:

USA: Motorola Literature Distribution; P.O. Box 20912; Phoenix, Arizona 85036.

EUROPE: Motorola Ltd.; European Literature Centre; 88 Tanners Drive, Blakelands, Milton Keynes, MK14 5BP, England.

JAPAN: Nippon Motorola Ltd.; 4-32-1, Nishi-Gotanda, Shinagawa-ku, Tokyo 141, Japan.

ASIA PACIFIC: Motorola Semiconductors H.K. Ltd.; Silicon Harbour Center, No. 2 Dai King Street, Tai Po Industrial Estate, Tai Po, N.T., Hong Kong.

