

SIL15E SERIES

3.0 Vin to 5.5 Vin Single output

15 A current rating

Input voltage range: 3.0 Vdc to 5.5 Vdc

Output voltage range: 0.8 Vdc to 3.63 Vdc

Ultra high efficiency: 95% @ 5 Vin and 3.3 Vout

Extremely low internal power dissipation

Minimal thermal design concerns

Designed in reliability: MTBF of >7 million hours per Telcordia SR-332

Ideal solution where board space is at a premium or tighter card pitch is required

Industry standard footprint and pin out

Available RoHS compliant

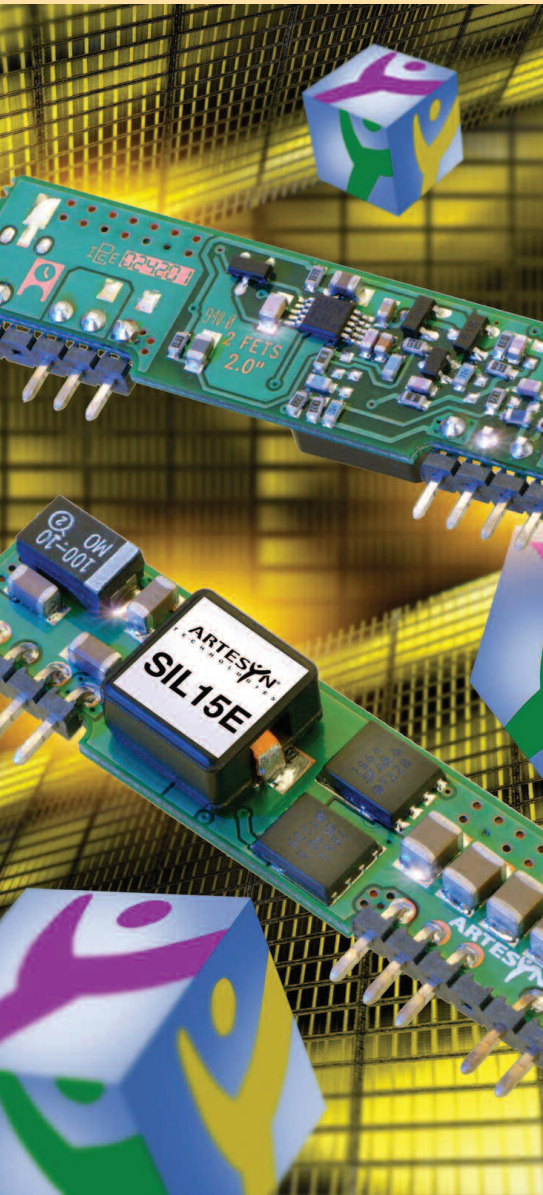

THE SIL15E series are non-isolated dc-dc converters packaged in a single-in-line footprint giving designers a cost effective solution for conversion from either a 5 V or 3.3 V input to output voltages of 0.8 Vdc and 3.63 Vdc. Local voltage conversion by the SIL15E series from existing 5 V or 3.3 V system voltages eliminates the need for redesign of existing power architectures when voltage requirements change. The SIL15E is designed for applications that include distributed power, workstations, optical network and wireless applications. Implemented using state of the art surface-mount technology

and automated manufacturing techniques, the SIL15E offers compact size and efficiencies of up to 95%.

[2 YEAR WARRANTY]



Stresses in excess of the maximum ratings can cause permanent damage to the device. Operation of the device is not implied at these or any other conditions in excess of those given in the specification. Exposure to absolute maximum ratings can adversely affect device reliability.

Absolute Maximum Ratings

Characteristic	Symbol	Min	Typ	Max	Units	Notes and Conditions
Input voltage - continuous	V_{in} (cont)	-0.3		5.5	V DC	$V_{in(+)} - V_{in(-)}$
Input voltage - peak/surge	V_{surge}	-0.3		6	V DC	2s max, non-repetitive
Operating temperature	T_{op}	-40		100	°C	Measured at thermal reference points, see Note 1 for thermal de-rating
Storage temperature	$T_{storage}$	-40		125	°C	
Output power (S1V8)	P_{out} (max)	0		29.70	W	
Output power (S2V5)	P_{out} (max)	0		41.25	W	
Output power (S3V3)	P_{out} (max)	0		54.45	W	
Output power (W3V3)	P_{out} (max)	0		54.45	W	

All specifications are typical at nominal input $V_{in} = 5V$, full load under any resistive load combination at 25°C unless otherwise stated.

Input Characteristics

Characteristic	Symbol	Min	Typ	Max	Units	Notes and Conditions
Input voltage - operating	V_{in} (oper)	3	5	5.5	V DC	See Note 2
Input current - no load	I_{in}		70	150	mA DC	V_{in} (min) - V_{in} (max), enabled
Input current - quiescent	I_{in} (off)		2		mA DC	Converter disabled
Inrush current (i^2t)	I_{inrush}		12		A ² μs	Complies with ETS300 132 Part 4.7, with recommended LISN
Input ripple current			110		mA rms	
Input fuse*				16	A	Slowblow/antisurge HRC recommended

*Fuse A - S(T) 1.25 x 0.25 inches
SIBA P/N 70-065-65/16ARS

Turn On/Off

Characteristic	Symbol	Min	Typ	Max	Units	Notes and Conditions
Input voltage - turn on	V_{in} (on)	2.25	2.70	3	V DC	Will regulate @ $V_{in} > 3V$ if $V_{out} \leq 2.5V$
Turn on delay - enabled, then power applied	T_{delay} (power)		20		msec	With the enable signal asserted, this is the time from when the input voltage reaches the minimum specified operating voltage until the output voltage is within the total regulation band
Turn on delay - power applied, then enabled	T_{delay} (enable)		20		msec	$V_{in} = V_{in}$ (nom), then enabled. This is the time taken until the output voltage is within the total error band
Rise time	T_{rise}		15		msec	From 10% to 90%; full resistive load, no external capacitance

Signal Electrical Interface

Characteristic - Signal Name	Symbol	Min	Typ	Max	Units	Notes and Conditions
At remote/control ON/OFF pin Open collector or equivalent compatible						See Notes 2 and 3 See Application Note 134 for Remote ON/OFF details
Control pin open circuit voltage	V_{ih}		0		V	$I_{ih} = 0 \mu\text{A}$; open circuit voltage
High level input current	I_{ih}			300	μA	Current flowing into control pin when pin is pulled high
High level input voltage	V_{ih}	1.2			Vin	Converter guaranteed OFF when control pin is greater than V_{ih} (min)
Acceptable high level leakage current	I_{ih} (leakage)			-10	μA	Acceptable leakage current from signal pin into the open collector driver (neg = from converter)
Low level input voltage	V_{il}	0		0.5	V	Converter guaranteed ON when control pin is less than V_{il} (max)
Low level input current	I_{il}			20	μA	$V_{il} < 0.4 \text{ V}$

Reliability and Service Life

Characteristic	Symbol	Min	Typ	Max	Units	Notes and Conditions
Mean time between failure	MTBF	680,000			Hours	MIL-HDBK-217F, $V_{in} = V_{in}(\text{nom})$; $I_{out} = I_{out}(\text{max})$; ambient 25°C; ground benign environment
Mean time between failure	MTBF	7,042,000			Hours	Telcordia SR-332
Mean time between failure	MTBF	TBA			Hours	Demonstrated. This entry will be periodically updated as the number of test hours increase

Other Specifications

Characteristic	Symbol	Min	Typ	Max	Units	Notes and Conditions
Switching frequency	F _{sw}		300		kHz	Fixed frequency
Weight			5		g	

EMC

Electromagnetic Compatibility

Phenomenon	Port	Standard	Test level	Criteria	Notes and conditions
Immunity:					
Conducted immunity		EN61000-4-6			
Radiated immunity		EN61000-4-3			
ESD	Enclosure	EN61000-4-2	6kV contact 8kV air	NP	As per ETS 300 386-1 table 5

Safety Agency Approvals

Characteristic	Notes and Conditions
UL	UL60950
TÜV Product Services	EN60950, IEC60950

Material Ratings

Characteristic - Signal Name	Notes and Conditions
Flammability rating	UL94V-0

Model Numbers

Model Number	Input Voltage	Output Voltage	Output Current (Max.)	Typical Efficiency	Max. Load Regulation
SIL15E-05S1V8-VJ	3.0 - 5.5VDC	1.8V	15A	89%	±1.0%
SIL15E-05S2V5-VJ	3.0 - 5.5VDC	2.5V	15A	92%	±1.0%
SIL15E-05S3V3-VJ	4.5 - 5.5VDC	3.3V	15A	94%	±1.0%
SIL15E-05W3V3-VJ	3.0 - 5.5VDC	0.8V - 3.63V	15A	94%	±1.0%

RoHS Compliance Ordering Information



The 'J' at the end of the part number indicates that the part is Pb-free (RoHS 6/6 compliant). TSE RoHS 5/6 (non Pb-free) compliant versions may be available on special request, please contact your local sales representative for details.

S1V8 Model

Input Characteristics

Characteristic	Symbol	Min	Typ	Max	Units	Notes and Conditions
Input current - operating	I_{in}		6.1	8	A DC	$V_{in} = V_{in} (nom)$; $I_{out} = I_{out} (max.)$; $V_O = V_O (nom)$
Reflected ripple current	$I_{in} (ripple)$		110		mA rms	$I_{out} = I_{out} (max.)$, measured without external filter
Input capacitance - internal filter	C_{input}		18.8		μF	Internal to converter
Input capacitance - external bypass	C_{bypass}	100			μF	Recommended customer added capacitance

S1V8 Model

Electrical Characteristics - O/P

Characteristic	Symbol	Min	Typ	Max	Units	Notes and Conditions
Nominal set-point voltage	$V_O (nom)$	1.75	1.8	1.85	V DC	$V_{in} = V_{in} (nom)$; $I_{out} = I_{out} (nom)$
Total regulation band	V_O	1.71		1.89	V DC	For all line, static load and temperature until end of life
Line regulation			0.2	0.5	%	$I_{out} = I_{out} (nom)$; $V_{in} (min)$ to $V_{in} (max)$
Load regulation				1	%	$V_{in} = V_{in} (nom)$; $I_{out} (min)$ to $I_{out} (max)$
Output current continuous	I_{out}	0		15	A DC	
Output current - short circuit	I_{sc}		10	20	A rms	Continuous, unit auto recovers from short, $V_O < 100mV$
Output voltage - noise	V_{p-p} V_{rms}			60 25	mV pk-pk mV rms	Measurement bandwidth: 20 MHz. See Application Note 134 for measurement set-up details

S1V8 Model

Electrical Characteristics - O/P

Characteristic	Symbol	Min	Typ	Max	Units	Notes and Conditions
Load transient response - peak deviation	V_{dynamic}		50		mV	Peak deviation for 50% to 75% step load, $di/dt = 100 \text{ mA}/\mu\text{sec}$. Measurement taken with no external capacitors
Load transient response - recovery	T_{recovery}		50		μsec	Settling time to within 1% of output set point voltage for 50% to 75% step load. Measurement taken with no external capacitors
External load capacitance	C_{ext}	0		10,000	μF	

S1V8 Model

Protection and Control Features

Characteristic	Symbol	Min	Typ	Max	Units	Notes and Conditions
Allowable output voltage		10		10	% %	Trim up (% of V_O nom). Trim down (% of V_O nom) See Application Note 134 for details of trim equations and trim curves
Remote sense voltage				10	%	If Trim up is invoked de-rate power accordingly (remote sense + trim $\leq 10\%$)

S1V8 Model

Efficiency

Characteristic	Symbol	Min	Typ	Max	Units	Notes and Conditions
Efficiency	η	88	89		%	$I_{\text{out}} = 100\% I_{\text{out}}(\text{max})$, $V_{\text{in}} = 5\text{V}$
Efficiency	η	90	91		%	$I_{\text{out}} = 50\% I_{\text{out}}(\text{max})$, $V_{\text{in}} = 5\text{V}$

S2V5 Model

Input Characteristics

Characteristic	Symbol	Min	Typ	Max	Units	Notes and Conditions
Input current - operating	I_{in}		8.15	9	A DC	$V_{in} = V_{in} (nom)$; $I_{out} = I_{out} (max.)$; $V_O = V_O (nom)$
Reflected ripple current	$I_{in} (ripple)$		110		mA rms	$I_{out} = I_{out} (max.)$, measured without external filter
Input capacitance - internal filter	C_{input}		18.8		μF	Internal to converter
Input capacitance - external bypass	C_{bypass}	100			μF	Recommended customer added capacitance

S2V5 Model

Electrical Characteristics - O/P

Characteristic	Symbol	Min	Typ	Max	Units	Notes and Conditions
Nominal set-point voltage	$V_O (nom)$	2.43	2.5	2.57	V DC	$V_{in} = V_{in} (nom)$; $I_{out} = I_{out} (nom)$
Total regulation band	V_O	2.38		2.612	V DC	For all line, static load and temperature until end of life
Line regulation			0.2	0.5	%	$I_{out} = I_{out} (nom)$; $V_{in} (min)$ to $V_{in} (max)$
Load regulation				1	%	$V_{in} = V_{in} (nom)$; $I_{out} (min)$ to $I_{out} (max)$
Output current continuous	I_{out}	0		15	A DC	
Output current - short circuit	I_{sc}		10	20	A rms	Continuous, unit auto recovers from short, $V_O < 100mV$
Output voltage - noise	V_{p-p} V_{rms}			60 25	mV pk-pk mV rms	Measurement bandwidth: 20 MHz. See Application Note 134 for measurement set-up details

S2V5 Model

Electrical Characteristics - O/P

Characteristic	Symbol	Min	Typ	Max	Units	Notes and Conditions
Load transient response - peak deviation	$V_{dynamic}$		50		mV	Peak deviation for 50% to 75% step load, $di/dt = 100 \text{ mA}/\mu\text{sec}$. Measurement taken with no external capacitors
Load transient response - recovery	$T_{recovery}$		50		μsec	Settling time to within 1% of output set point voltage for 50% to 75% step load. Measurement taken with no external capacitors
External load capacitance	C_{ext}	0		10,000	μF	

S2V5 Model

Protection and Control Features

Characteristic	Symbol	Min	Typ	Max	Units	Notes and Conditions
Allowable output voltage*		10		10	% %	Trim up (% of V_O nom). Trim down (% of V_O nom) See Application Note 134 for details of trim equations and trim curves
Remote sense voltage				10	%	If Trim up is invoked de-rate power accordingly (remote sense + trim $\leq 10\%$)

* V_{in} (min) = 3.3V at max. trim-up

S2V5 Model

Efficiency

Characteristic	Symbol	Min	Typ	Max	Units	Notes and Conditions
Efficiency	η	91	92		%	$I_{out} = 100\% I_{out} (max)$, $V_{in} = 5V$
Efficiency	η	92	93		%	$I_{out} = 50\% I_{out} (max)$, $V_{in} = 5V$

S3V3 Model

Input Characteristics

Characteristic	Symbol	Min	Typ	Max	Units	Notes and Conditions
Input current - operating	I_{in}		10.6	11.8	A DC	$V_{in} = V_{in} (nom)$; $I_{out} = I_{out} (max.)$; $V_O = V_O (nom)$
Reflected ripple current	$I_{in} (ripple)$		110		mA rms	$I_{out} = I_{out} (max.)$, measured without external filter
Input capacitance - internal filter	C_{input}		18.8		μF	Internal to converter
Input capacitance - external bypass	C_{bypass}	100			μF	Recommended customer added capacitance

S3V3 Model

Electrical Characteristics - O/P

Characteristic	Symbol	Min	Typ	Max	Units	Notes and Conditions
Nominal set-point voltage	$V_O (nom.)$	3.21	3.3	3.39	VDC	$V_{in} = V_{in} (nom)$; $I_{out} = I_{out} (nom)$
Total regulation band	V_O	3.15		3.45	VDC	For all line, static load and temperature until end of life
Line regulation			0.2	0.5	%	$I_{out} = I_{out} (nom)$; $V_{in} (min)$ to $V_{in} (max)$
Load regulation				1	%	$V_{in} = V_{in} (nom)$; $I_{out} (min)$ to $I_{out} (max)$
Output current continuous	I_{out}	0		15	ADC	
Output current - short circuit	I_{sc}		10	20	A rms	Continuous, unit auto recovers from short, $V_O < 100mV$
Output voltage - noise	V_{p-p} V_{rms}			60 25	mV pk-pk mV rms	Measurement bandwidth 20 MHz See Application Note 134 for set-up details

S3V3 Model

Electrical Characteristics - O/P

Characteristic	Symbol	Min	Typ	Max	Units	Notes and Conditions
Load transient response - peak deviation	$V_{dynamic}$		50		mV	Peak deviation for 50% to 75% step load, $di/dt = 100 \text{ mA}/\mu\text{sec}$. Measurement taken with no external capacitors
Load transient response - recovery	$T_{recovery}$		50		μsec	Settling time to within 1% of output set point voltage for 50% to 75% step load. Measurement taken with no external capacitors
External load capacitance	C_{ext}	0		10,000	μF	

S3V3 Model

Protection and Control Features

Characteristic	Symbol	Min	Typ	Max	Units	Notes and Conditions
Allowable output voltage		10		10	% %	Trim up (% of V_O nom). Trim down (% of V_O nom) See Application Note 134 for details of trim equations and trim curves
Remote sense voltage				10	%	If Trim up is invoked de-rate power accordingly (remote sense + trim $\leq 10\%$)

S3V3 Model

Efficiency

Characteristic	Symbol	Min	Typ	Max	Units	Notes and Conditions
Efficiency	η	93	94		%	$I_{out} = 100\% I_{out} (max)$, $V_{in} = V_{in} (nom)$
Efficiency	η	94	95		%	$I_{out} = 50\% I_{out} (max)$, $V_{in} = V_{in} (nom)$

W3V3 Model

Input Characteristics

Characteristic	Symbol	Min	Typ	Max	Units	Notes and Conditions
Input current - operating	I_{in}		10.6	11.8	A DC	$V_{in} = V_{in} (nom)$; $I_{out} = I_{out} (max.)$; $V_O = V_O (nom)$
Reflected ripple current	$I_{in} (ripple)$		110		mA rms	$I_{out} = I_{out} (max.)$, measured without external filter
Input capacitance - internal filter	C_{input}		18.8		μF	Internal to converter
Input capacitance - external bypass	C_{bypass}	100			μF	Recommended customer added capacitance

W3V3 Model

Electrical Characteristics - O/P

Characteristic	Symbol	Min	Typ	Max	Units	Notes and Conditions
Nominal set-point voltage	$V_O (nom.)$	3.21	3.3	3.39	VDC	$V_{in} = V_{in} (nom)$; $I_{out} = I_{out} (nom)$
Total regulation band	V_O	3.15		3.45	VDC	For all line, static load and temperature until end of life
Line regulation			0.2	0.5	%	$I_{out} = I_{out} (nom)$; $V_{in} (min)$ to $V_{in} (max)$
Load regulation				1	%	$V_{in} = V_{in} (nom)$; $I_{out} (min)$ to $I_{out} (max)$
Output current continuous	I_{out}	0		15	ADC	
Output current - short circuit	I_{sc}		10	20	A rms	Continuous, unit auto recovers from short, $V_O < 100mV$
Output voltage - noise	V_{p-p} V_{rms}			60 25	mV pk-pk mV rms	Measurement bandwidth 20MHz See Application Note 134 for set-up details

W3V3 Model

Electrical Characteristics - O/P

Characteristic	Symbol	Min	Typ	Max	Units	Notes and Conditions
Load transient response - peak deviation	$V_{dynamic}$		50		mV	Peak deviation for 50% to 75% step load, $di/dt = 100 \text{ mA}/\mu\text{sec}$. Measurement taken with no external capacitors
Load transient response - recovery	$T_{recovery}$		50		μsec	Settling time to within 1% of output set point voltage for 50% to 75% step load. Measurement taken with no external capacitors
External load capacitance	C_{ext}	0		10,000	μF	

W3V3 Model

Protection and Control Features

Characteristic	Symbol	Min	Typ	Max	Units	Notes and Conditions
Allowable output voltage		75		10	% %	Trim up (% of V_O nom). Trim down (% of V_O nom) See Application Note 134 for details of trim equations and trim curves
Remote sense voltage				10	%	If Trim up is invoked de-rate power accordingly (remote sense + trim $\leq 10\%$)

W3V3 Model

Efficiency

Characteristic	Symbol	Min	Typ	Max	Units	Notes and Conditions
Efficiency	η	93	94		%	$I_{out} = 100\% I_{out} (max)$, $V_{in} = V_{in} (nom)$
Efficiency	η	94	95		%	$I_{out} = 50\% I_{out} (max)$, $V_{in} = V_{in} (nom)$

S1V8 Model

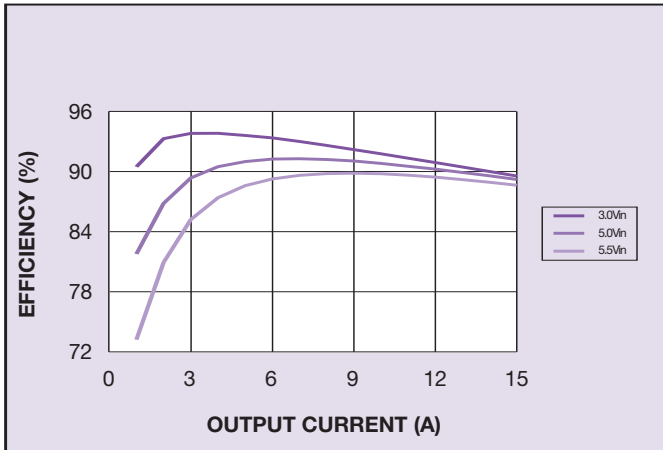

Figure 1: Efficiency vs Load

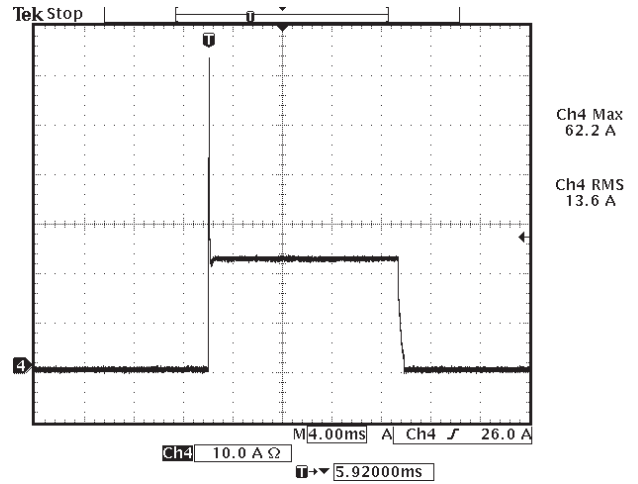

Figure 2: Short Circuit Characteristic (Channel 4: Is/c)

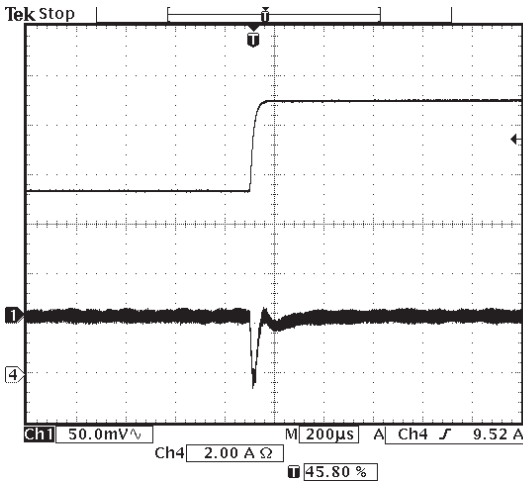

Figure 3: Typical Transient Response 50% - 75% Step Load Change (Channel 1: Vo, Channel 4: Io)

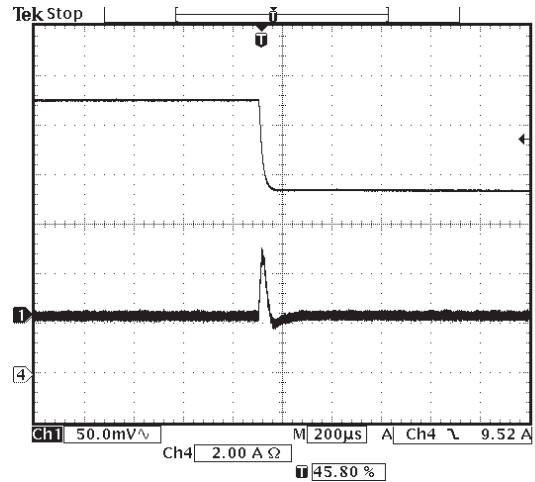

Figure 4: Typical Transient Response 75% - 50% Step Load Change (Channel 1: Vo, Channel 4: Io)

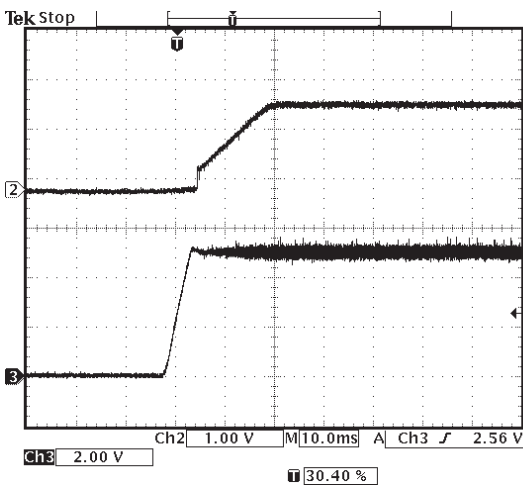

Figure 5: Typical Power-up Characteristic (Channel 2: Vo, Channel 3: Vin)

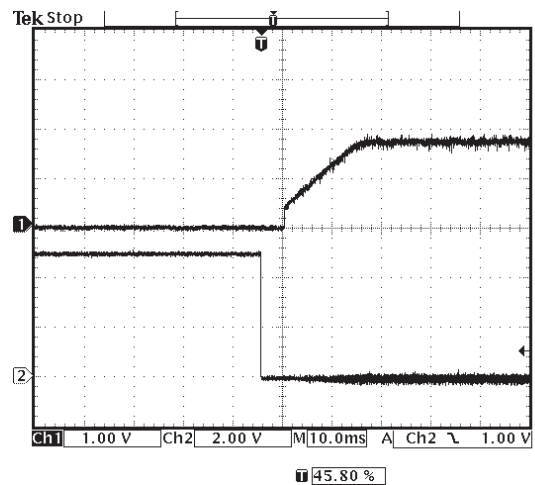

Figure 6: Control On/Off Characteristic (Channel 1: Vo, Channel 2: Remote ON/OFF)

S1V8 Model

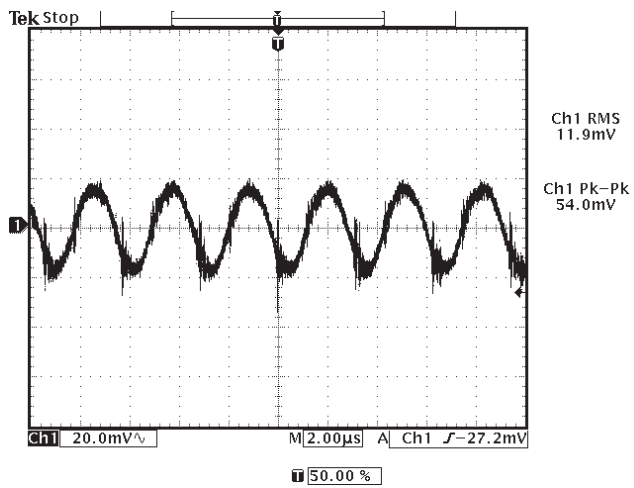

Figure 7: Typical Ripple and Noise
(Channel 1: Vo)

S2V5 Model

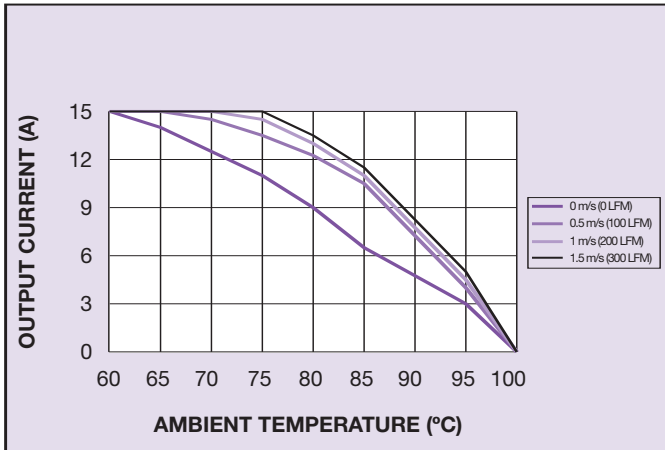

Figure 8: De-rating Curve with $V_{in} = 3.3V$ and No Trim

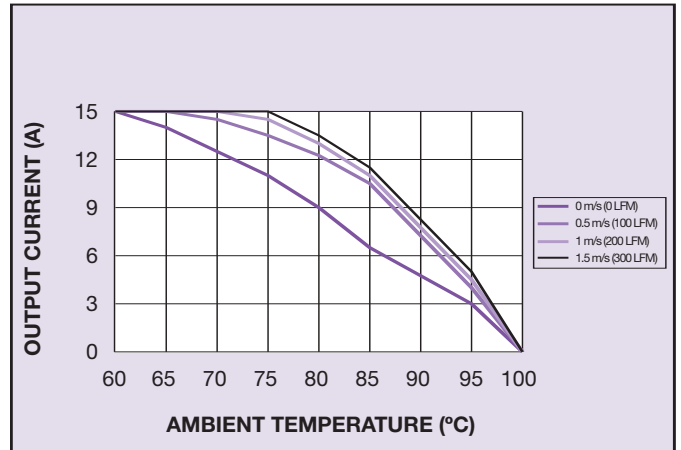

Figure 9: De-rating Curve with $V_{in} = 5V$ and No Trim

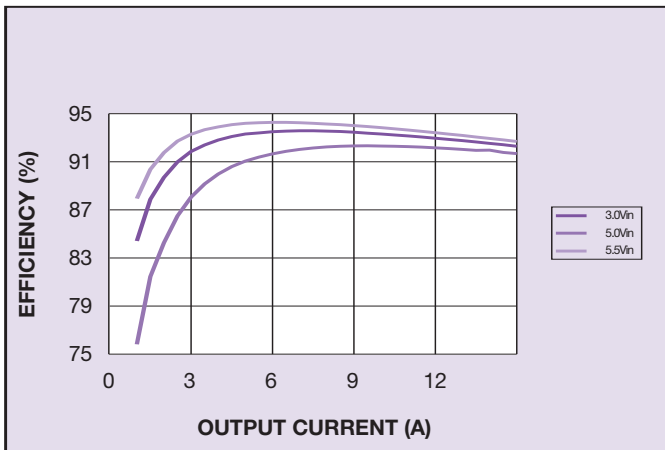

Figure 10: Efficiency vs Load

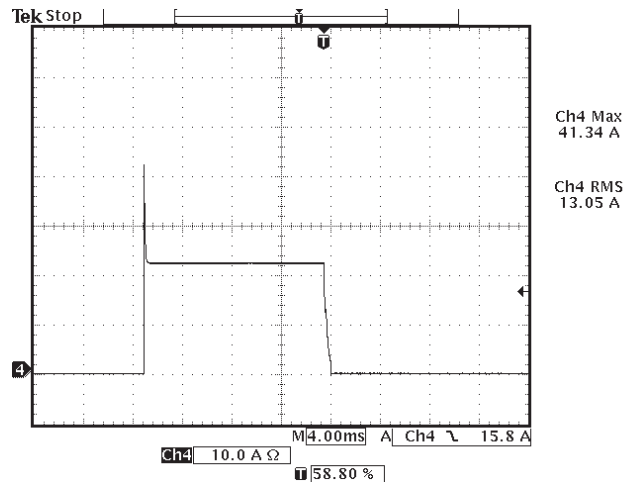

Figure 11: Short Circuit Characteristic (Channel 4: $I_{s/c}$)

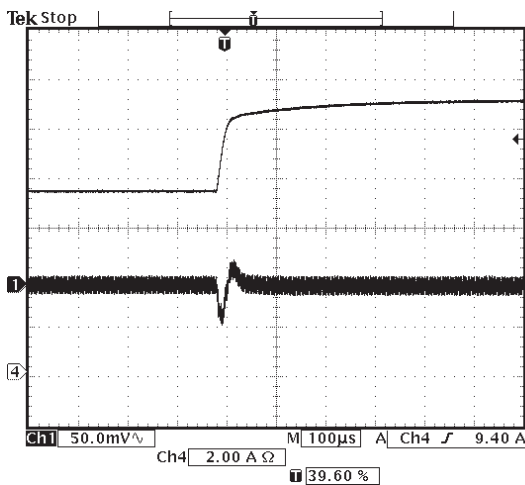

Figure 12: Typical Transient Response 50% - 75% Step Load Change (Channel 1: V_o , Channel 4: I_o)

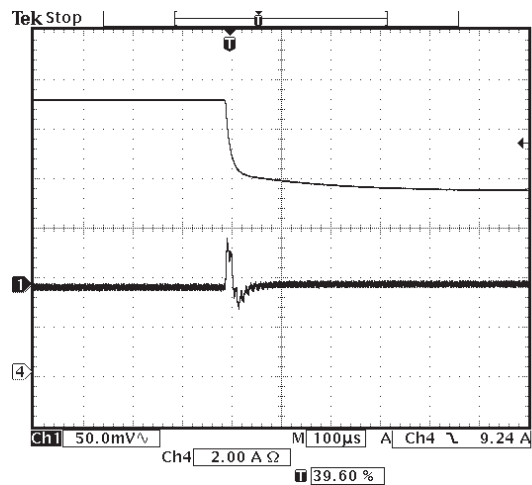

Figure 13: Typical Transient Response 75% - 50% Step Load Change (Channel 1: V_o , Channel 4: I_o)

S2V5 Model

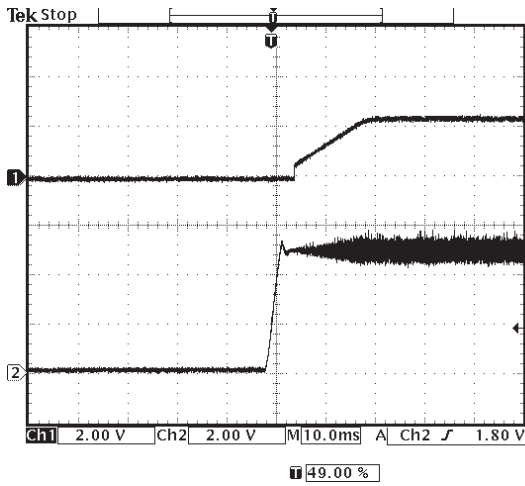

Figure 14: Typical Power-up Characteristic (Channel 1: Vo, Channel 2: Vin)

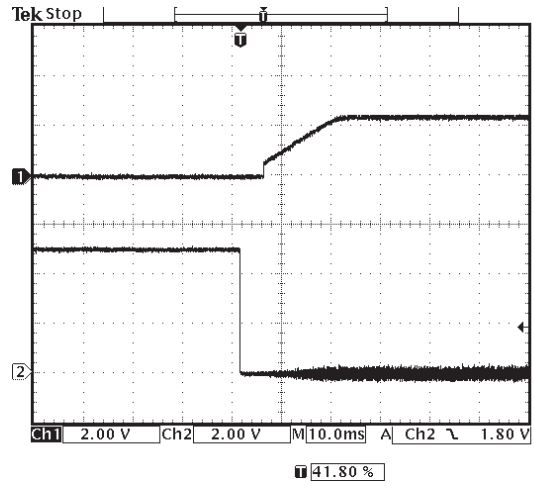

Figure 15: Control On/Off Characteristic (Channel 1: Vo, Channel 2: Remote ON/OFF)

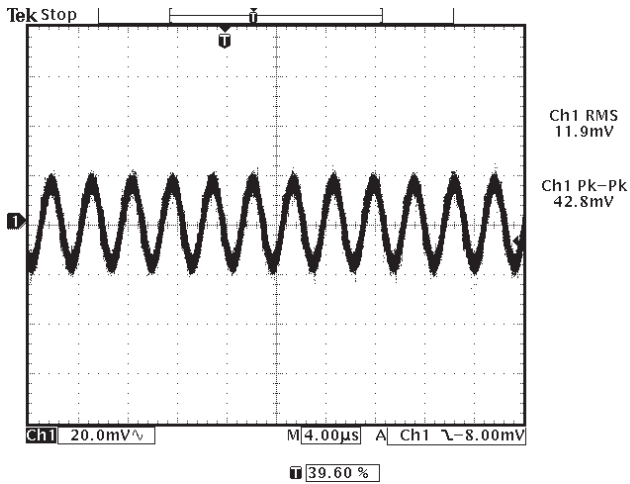

Figure 16: Typical Ripple and Noise (Channel 1: Vo)

S3V3 Model

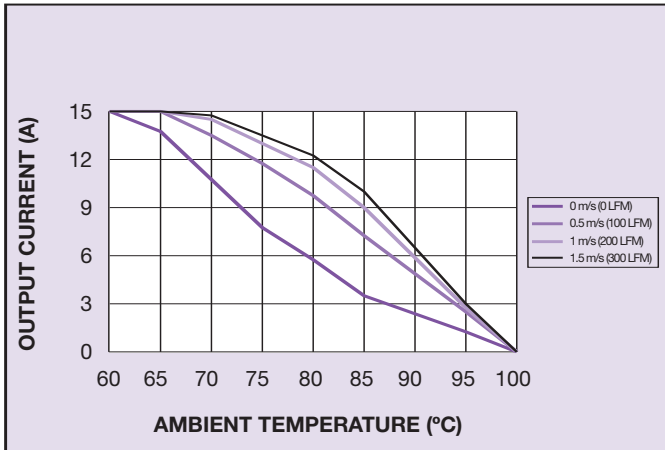

Figure 17: De-rating Curve with $V_{in} = 5V$ and No Trim

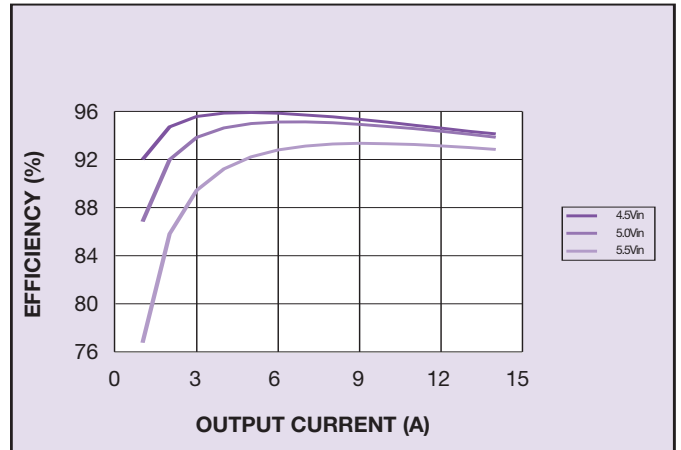

Figure 18: Efficiency vs Load

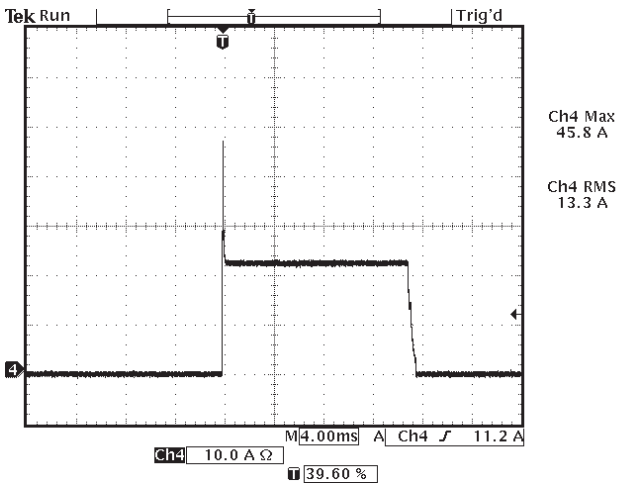

Figure 19: Short Circuit Characteristic (Channel 4: Is/c)

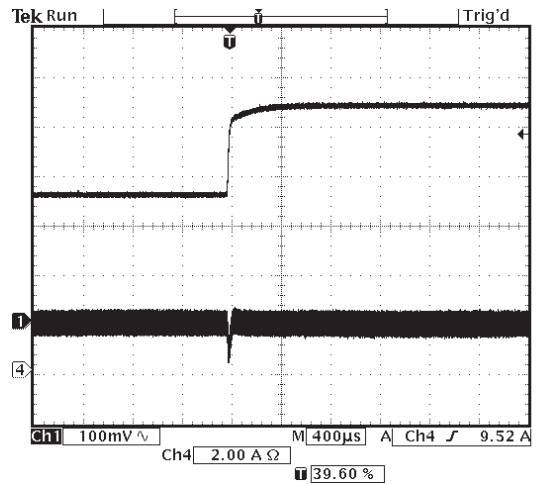

Figure 20: Typical Transient Response 50% - 75% Step Load Change (Channel 1: Vo, Channel 4: Io)

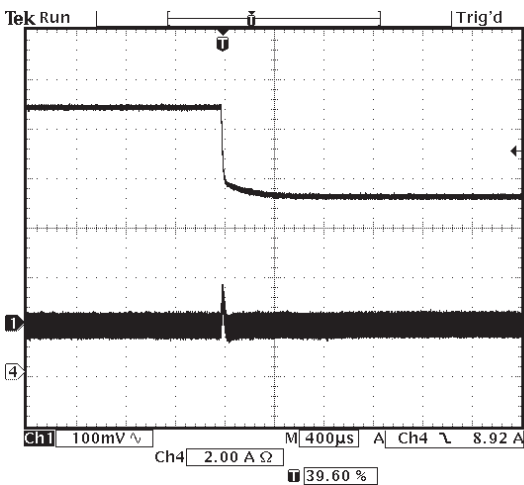

Figure 21: Typical Transient Response 75% - 50% Step Load Change (Channel 1: Vo, Channel 4: Io)

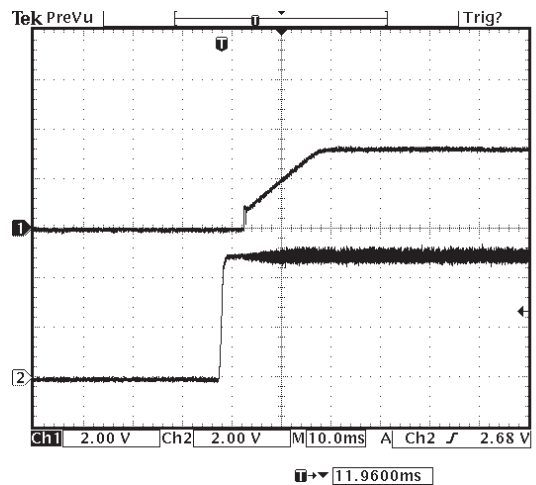

Figure 22: Typical Power-up Characteristic (Channel 1: Vo, channel 2: Vin)

S3V3 Model

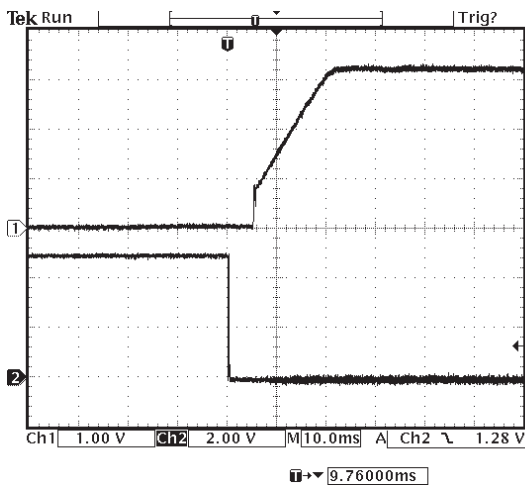

Figure 23: Control On/Off Characteristic (Channel 1: Vo, Channel 2: Remote ON/OFF)

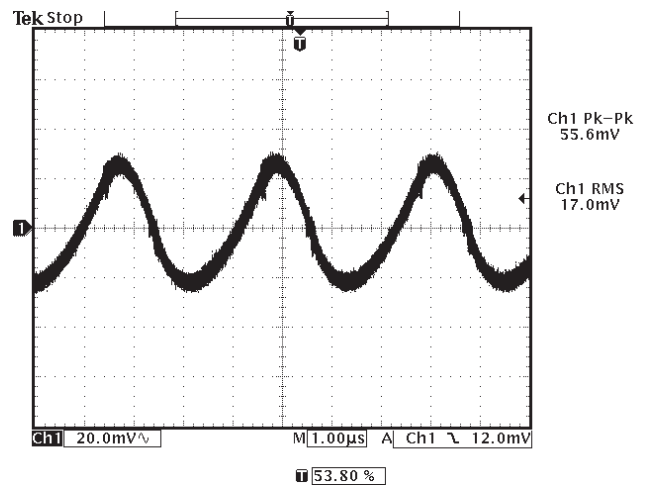

Figure 24: Typical Ripple and Noise (Channel 1: Vo)

W3V3 Model

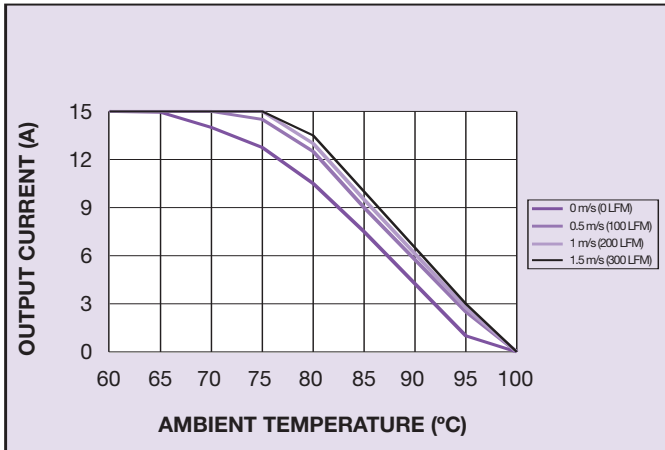

Figure 25: De-rating Curve with $V_{in} = 5V$, $V_{out} = 0.8V$

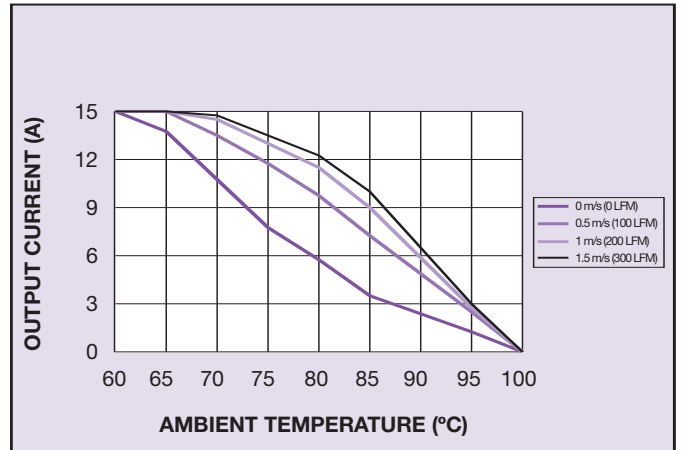

Figure 26: De-rating Curve with $V_{in} = 5V$ and No Trim

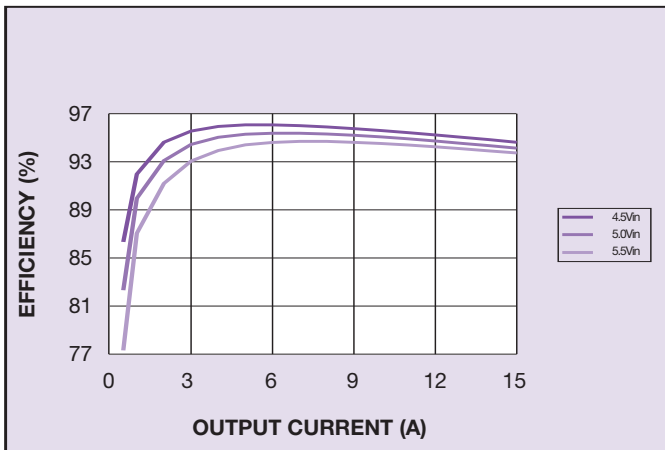

Figure 27: Efficiency vs Load

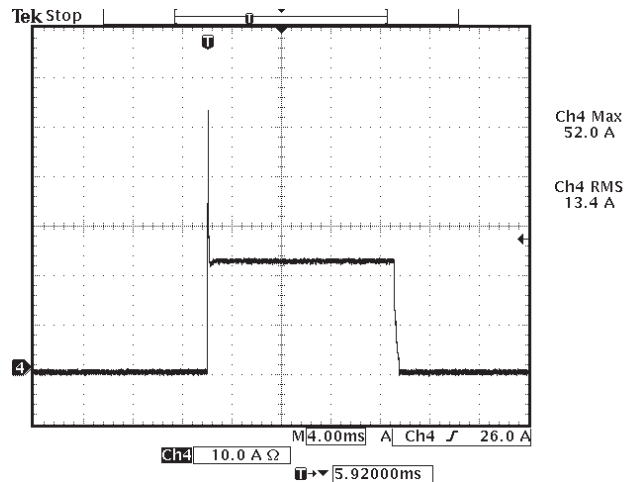

Figure 28: Short Circuit Characteristic (Channel 4: I_o)

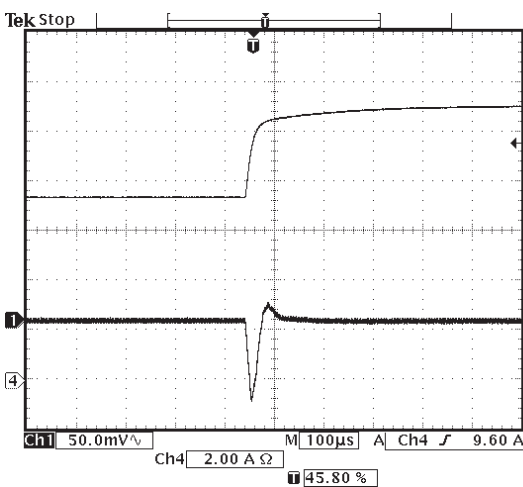

Figure 29: Typical Transient Response 50% - 75% Step Load Change (Channel 1: V_o , Channel 4: I_o)

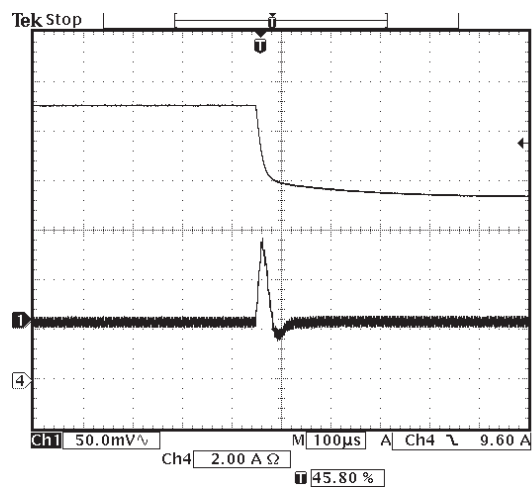

Figure 30: Typical Transient Response 75% - 50% Step Load Change (Channel 1: V_o , Channel 4: I_o)

W3V3 Model

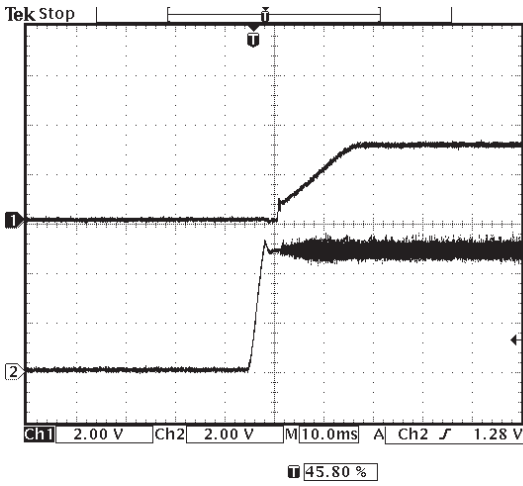

Figure 31: Typical Power-up Characteristic (Channel 1: Vo, Channel 2: Vin)

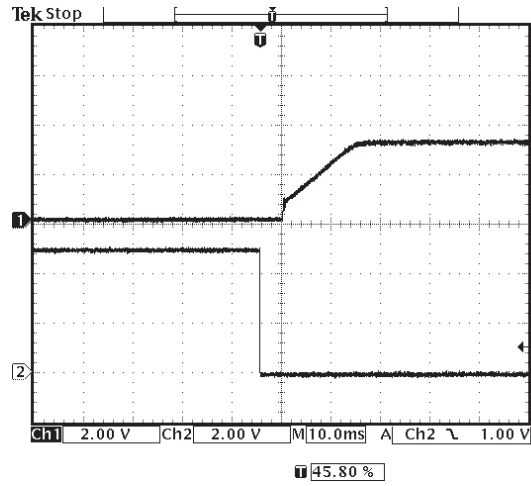

Figure 32: Control On/Off Characteristic (Channel 1: Vo, Channel 2: Remote ON/OFF)

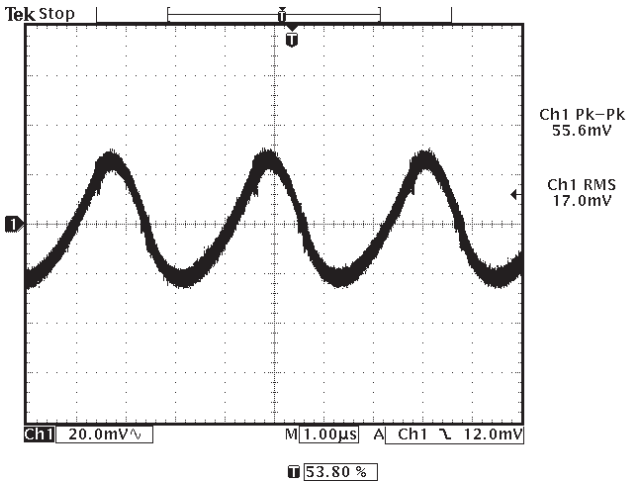

Figure 33: Typical Ripple and Noise (Channel 1: Vo)

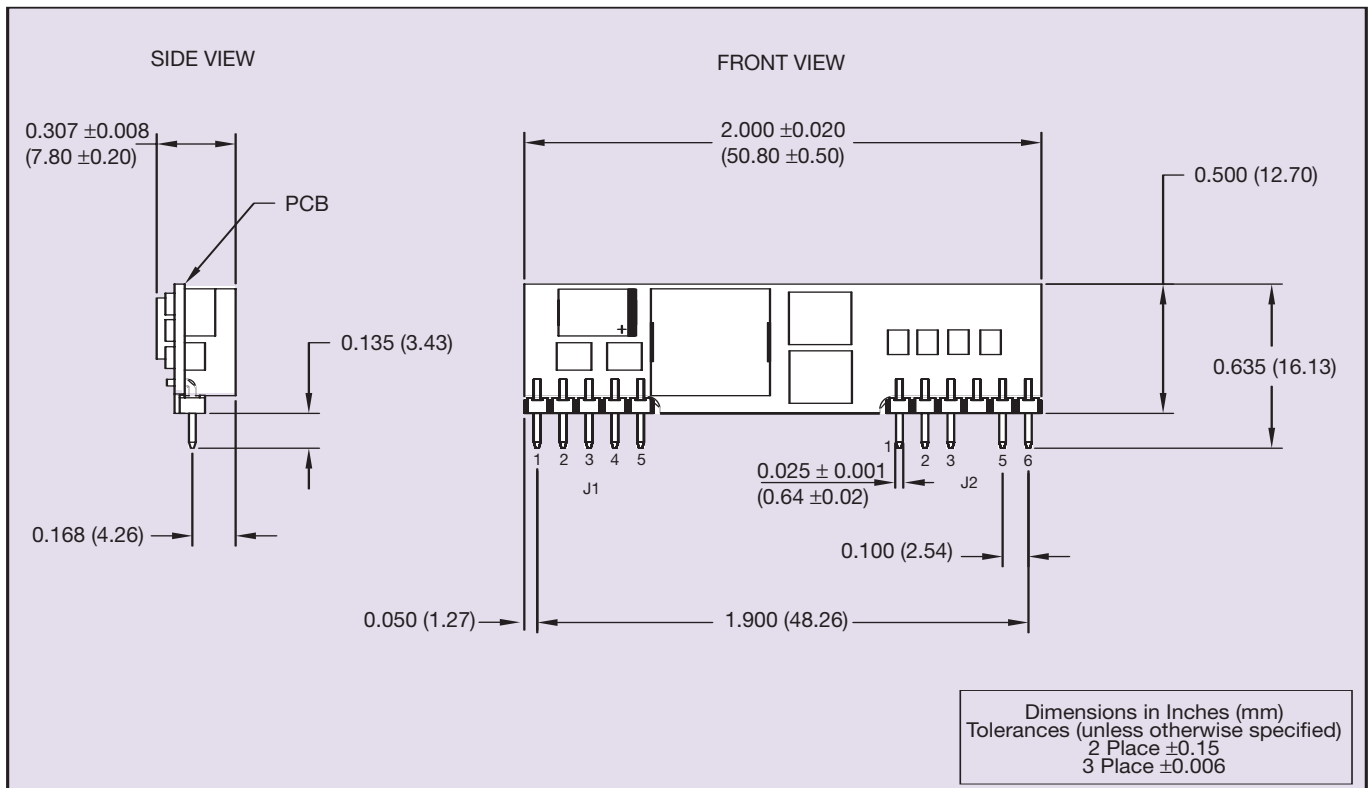

Figure 34: Mechanical Drawing

Pin Connections	
Pin No.	Function
J1-1	+Vout
J1-2	+Vout
J1-3	Remote Sense (+)
J1-4	+Vout
J1-5	Ground
J2-1	Ground
J2-2	+Vin
J2-3	+Vin
J2-4	No Pin
J2-5	Trim
J2-6	Remote ON/OFF

Figure 35: Pinout

Note 1

Thermal reference is defined as the highest temperature measured at any one of the specified thermal reference points. See Figure 36: Thermal reference points.

Note 2

The Remote ON/OFF pin is referenced to ground.

Note 3

The SIL15E-05 features a 'Negative Logic' Remote ON/OFF operation. If not using the Remote ON/OFF pin, leave the pin open (the converter will be on). The Remote ON/OFF pin is referenced to ground.

The following conditions apply for the SIL15E:

Configuration	Converter Operation
Remote pin open circuit	Unit is ON
Remote pin pulled low	Unit is ON
Remote pin pulled high [$V_{on/off} > 1.2V$]	Unit is OFF

A 'Positive Logic' Remote ON/OFF version is also possible with this converter. To order please place the suffix 'R' at the end of the model number, e.g. SIL15E-05W3V3-VRJ.

Note 4

Thermal reference set up: Unit mounted on an edge card test board 203mm x 190mm. Test board mounted vertically. For test details and recommended set-up see Application Note 134.

CAUTION: Hazardous internal voltages and high temperatures. Ensure that unit is accessible only to trained personnel. The user must provide the recommended fusing in order to comply with safety approvals.

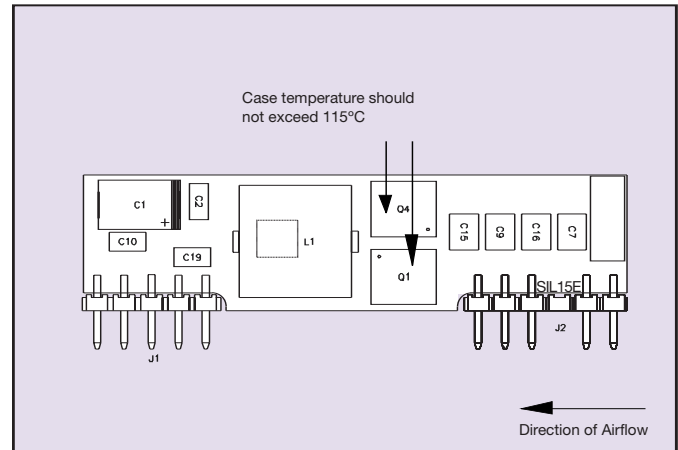

Figure 36: Thermal Reference Points

NORTH AMERICAe-mail: sales.us@artesyn.com☎ 800 769 7274
☎ +508 628 5600**EUROPEAN LOCATIONS**e-mail: sales.europe@artesyn.com**IRELAND**

☎ +353 24 93130

AUSTRIA

☎ +43 1 80150

FAR EAST LOCATIONSe-mail: sales.asia@artesyn.com**HONG KONG**

☎ +852 2699 2868

Longform Datasheet © Artesyn Technologies® 2005

The information and specifications contained in this datasheet are believed to be correct at time of publication. However, Artesyn Technologies accepts no responsibility for consequences arising from printing errors or inaccuracies. Specifications are subject to change without notice. No rights under any patent accompany the sale of any such product(s) or information contained herein.