

PBSS8110Z

100 V, 1 A NPN low V_{CEsat} (BISS) transistor

Rev. 01 — 26 April 2004

Product data sheet

1. Product profile

1.1 General description

NPN low V_{CEsat} transistor in a plastic SOT223 (SC-73) package.

1.2 Features

- SOT223 package
- Low collector-emitter saturation voltage V_{CEsat}
- High collector current capability I_C and I_{CM}
- High efficiency, leading to less heat generation.

1.3 Applications

- Major application segments:
 - ◆ Automotive 42 V power
 - ◆ Telecom infrastructure
 - ◆ Industrial.
- DC-to-DC converter
- Peripheral driver
 - ◆ Driver in low supply voltage applications (e.g. lamps and LEDs)
 - ◆ Inductive load drivers (e.g. relays, buzzers and motors).

1.4 Quick reference data

Table 1: Quick reference data

Symbol	Parameter	Conditions	Min	Typ	Max	Unit
V_{CEO}	collector-emitter voltage		-	-	100	V
I_C	collector current (DC)		-	-	1	A
I_{CM}	peak collector current		-	-	3	A
R_{CEsat}	equivalent on-resistance		-	-	200	m Ω

PHILIPS

2. Pinning information

Table 2: Discrete pinning

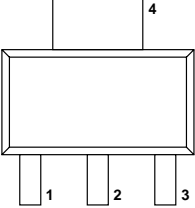
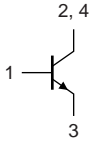
Pin	Description	Simplified outline	Symbol
1	base	 <p>Top view</p>	 <p>sym016</p>
2, 4	collector		
3	emitter		

3. Ordering information

Table 3: Ordering information

Type number	Package		
	Name	Description	Version
PBSS8110Z	-	plastic surface mounted package; collector pad for good heat transfer; 4 leads	SOT223

4. Marking

Table 4: Marking

Type number	Marking code ^[1]
PBSS8110Z	PB8110

[1] Made in Hong Kong.

5. Limiting values

Table 5: Limiting values

In accordance with the Absolute Maximum Rating System (IEC 60134).

Symbol	Parameter	Conditions	Min	Max	Unit	
V_{CBO}	collector-base voltage	open emitter	-	120	V	
V_{CEO}	collector-emitter voltage	open base	-	100	V	
V_{EBO}	emitter-base voltage	open collector	-	5	V	
I_{CM}	peak collector current	$T_{j(max)}$	-	3	A	
I_C	collector current (DC)		-	1	A	
I_B	base current (DC)		-	0.3	A	
P_{tot}	total power dissipation	$T_{amb} \leq 25\text{ °C}$	[1]	-	650	mW
			[2]	-	1000	mW
			[3]	-	1.4	W
T_j	junction temperature		-	150	°C	
T_{amb}	operating ambient temperature		-65	+150	°C	
T_{stg}	storage temperature		-65	+150	°C	

[1] Device mounted on a FR4 printed-circuit board, single-sided copper, tin-plated, standard footprint.

[2] Device mounted on a FR4 printed-circuit board, single-sided copper, tin-plated, 1 cm² collector mounting pad.

[3] Device mounted on a FR4 printed-circuit board, single-sided copper, tin-plated, 6 cm² collector mounting pad.

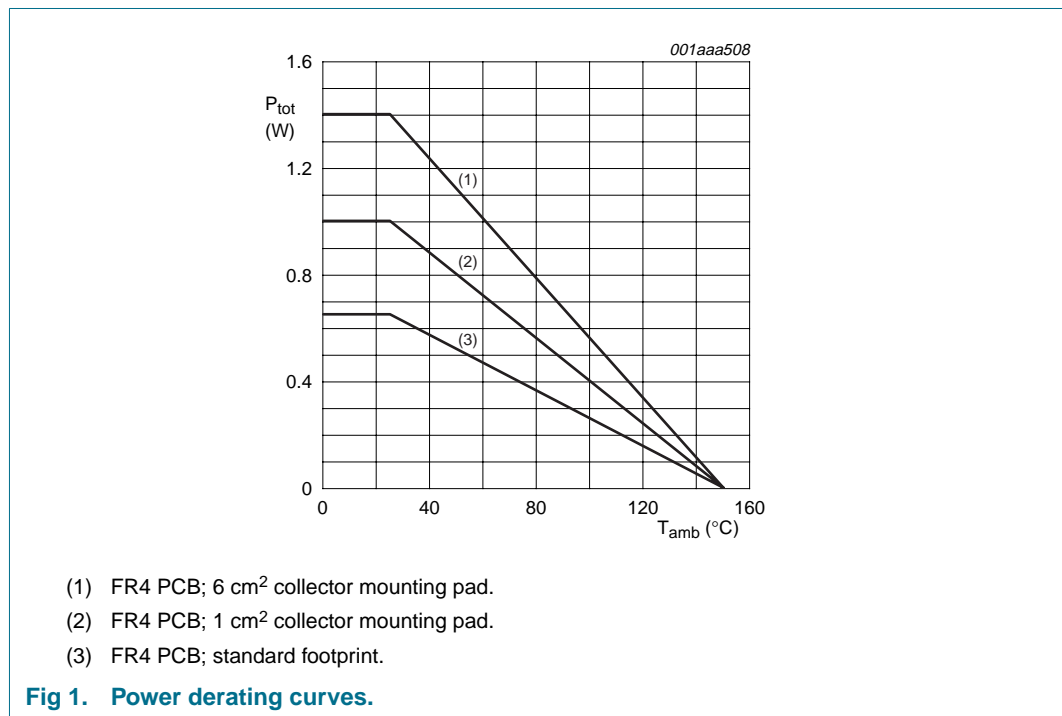

6. Thermal characteristics

Table 6: Thermal characteristics

Symbol	Parameter	Conditions	Typ	Unit	
$R_{th(j-a)}$	thermal resistance from junction to ambient	in free air	[1]	192	K/W
			[2]	125	K/W
			[3]	89	K/W
$R_{th(j-s)}$	thermal resistance from junction to soldering point	in free air	[1]	17	K/W

- [1] Device mounted on a FR4 printed-circuit board, single-sided copper, tin-plated, standard footprint.
- [2] Device mounted on a FR4 printed-circuit board, single-sided copper, tin-plated, 1 cm² collector mounting pad.
- [3] Device mounted on a FR4 printed-circuit board, single-sided copper, tin-plated, 6 cm² collector mounting pad.

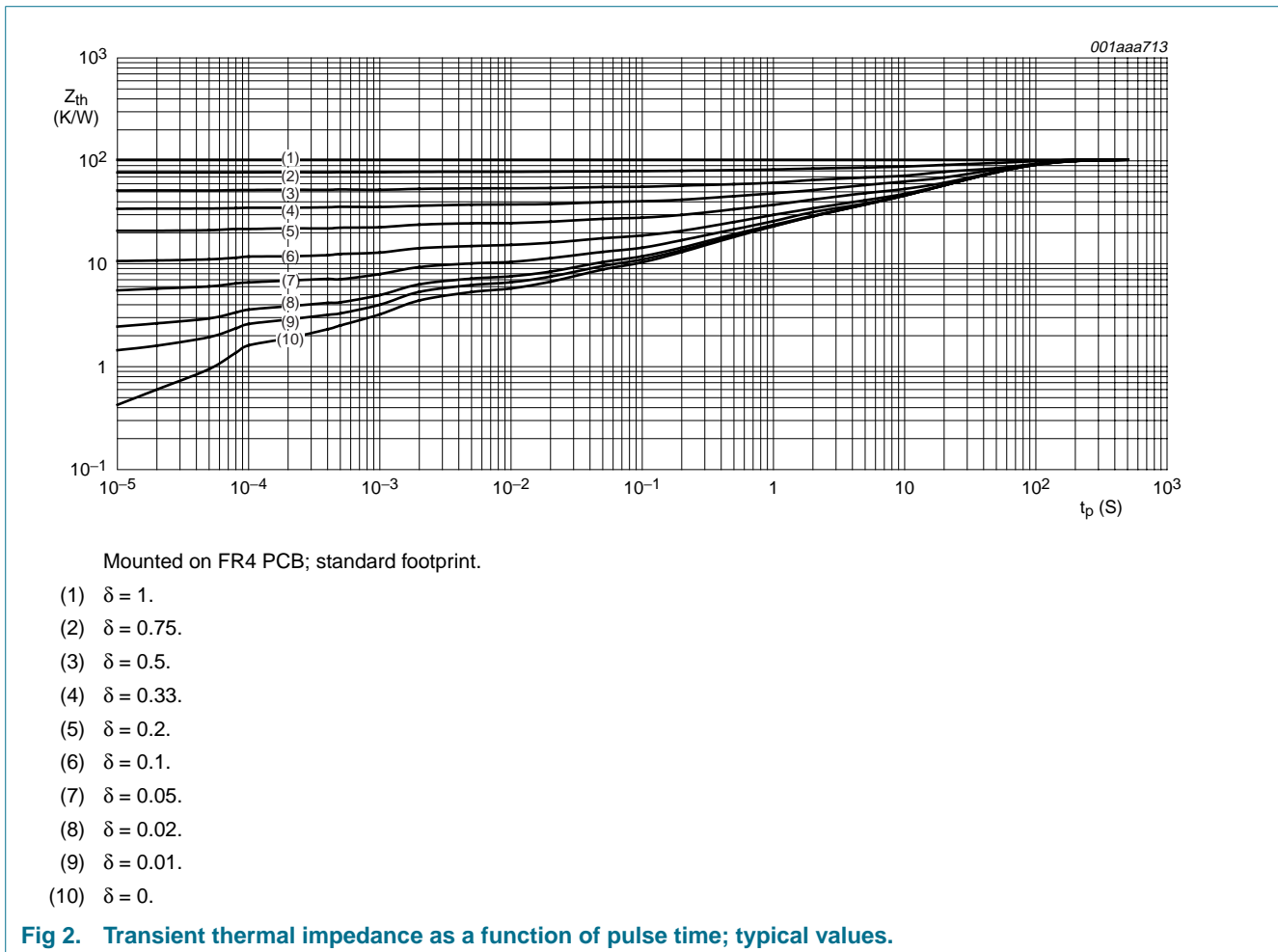

7. Characteristics

Table 7: Characteristics
 $T_j = 25\text{ }^\circ\text{C}$; unless otherwise specified.

Symbol	Parameter	Conditions	Min	Typ	Max	Unit	
I_{CBO}	collector-base cut-off current	$V_{CB} = 80\text{ V}; I_E = 0\text{ A}$	-	-	100	nA	
		$V_{CB} = 80\text{ V}; I_E = 0\text{ A}; T_j = 150\text{ }^\circ\text{C}$	-	-	50	μA	
I_{CES}	collector-emitter cut-off current	$V_{CE} = 80\text{ V}; V_{BE} = 0\text{ V}$	-	-	100	nA	
I_{EBO}	emitter-base cut-off current	$V_{EB} = 4\text{ V}; I_C = 0\text{ A}$	-	-	100	nA	
h_{FE}	DC current gain	$V_{CE} = 10\text{ V}; I_C = 1\text{ mA}$	150	-	-		
		$V_{CE} = 10\text{ V}; I_C = 250\text{ mA}$	150	-	500		
		$V_{CE} = 10\text{ V}; I_C = 0.5\text{ A}$	[1]	100	-	-	
		$V_{CE} = 10\text{ V}; I_C = 1\text{ A}$	[1]	80	-	-	
V_{CEsat}	collector-emitter saturation voltage	$I_C = 100\text{ mA}; I_B = 10\text{ mA}$	-	-	40	mV	
		$I_C = 500\text{ mA}; I_B = 50\text{ mA}$	-	-	120	mV	
		$I_C = 1\text{ A}; I_B = 100\text{ mA}$	-	-	200	mV	
R_{CEsat}	equivalent on-resistance	$I_C = 1\text{ A}; I_B = 100\text{ mA}$	[1]	-	160	$\text{m}\Omega$	
V_{BEsat}	base-emitter saturation voltage	$I_C = 1\text{ A}; I_B = 100\text{ mA}$	-	-	1.05	V	
V_{BEon}	base-emitter turn-on voltage	$V_{CE} = 10\text{ V}; I_C = 1\text{ A}$	-	-	0.9	V	
f_T	transition frequency	$V_{CE} = 10\text{ V}; I_C = 50\text{ mA}; f = 100\text{ MHz}$	100	-	-	MHz	
C_c	collector capacitance	$V_{CB} = 10\text{ V}; I_E = I_e = 0\text{ A}; f = 1\text{ MHz}$	-	-	7.5	pF	

[1] Pulse test $t_p \leq 300\text{ }\mu\text{s}$; $\delta \leq 0.02$.

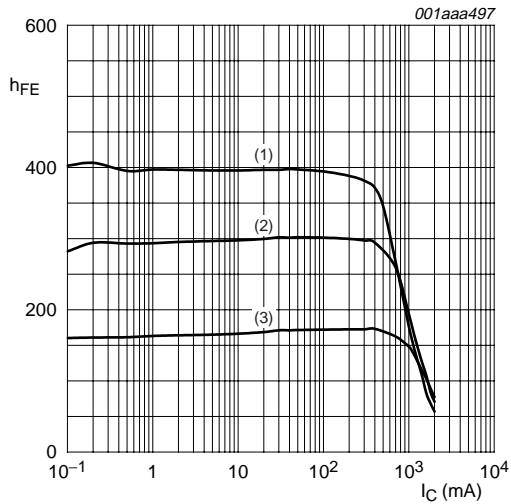

$V_{CE} = 10\text{ V.}$
 (1) $T_{amb} = 100\text{ }^{\circ}\text{C.}$
 (2) $T_{amb} = 25\text{ }^{\circ}\text{C.}$
 (3) $T_{amb} = -55\text{ }^{\circ}\text{C.}$

Fig 3. DC current gain as a function of collector current; typical values.

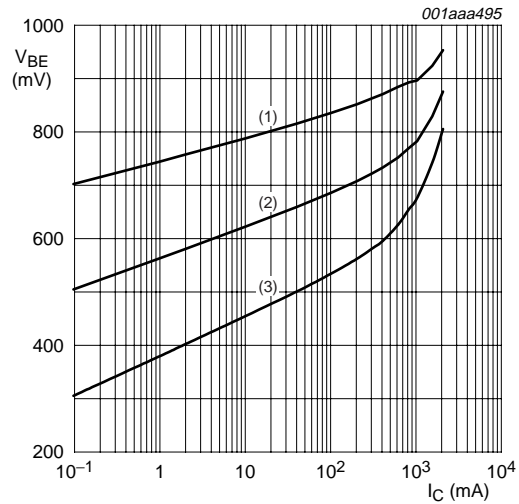

$V_{CE} = 10\text{ V.}$
 (1) $T_{amb} = -55\text{ }^{\circ}\text{C.}$
 (2) $T_{amb} = 25\text{ }^{\circ}\text{C.}$
 (3) $T_{amb} = 100\text{ }^{\circ}\text{C.}$

Fig 4. Base-emitter voltage as a function of collector current; typical values.

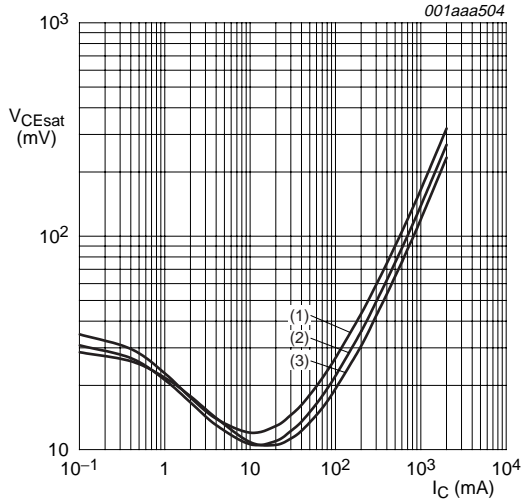

$I_C/I_B = 10.$
 (1) $T_{amb} = 100\text{ }^{\circ}\text{C.}$
 (2) $T_{amb} = 25\text{ }^{\circ}\text{C.}$
 (3) $T_{amb} = -55\text{ }^{\circ}\text{C.}$

Fig 5. Collector-emitter saturation voltage as a function of collector current; typical values.

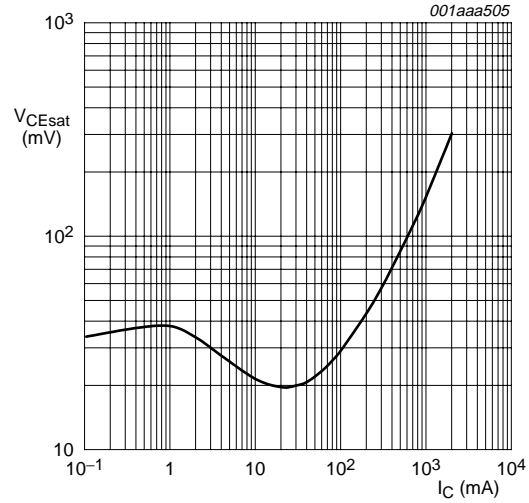

$I_C/I_B = 20; T_{amb} = 25\text{ }^{\circ}\text{C.}$

Fig 6. Collector-emitter saturation voltage as a function of collector current; typical values.

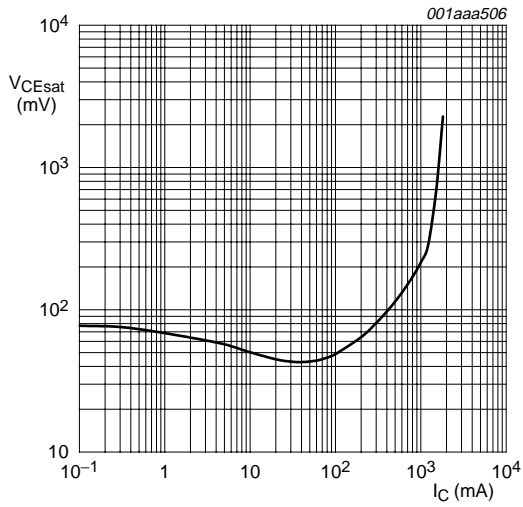

$I_C/I_B = 50$; $T_{amb} = 25\text{ }^\circ\text{C}$.

Fig 7. Collector-emitter saturation voltage as a function of collector current; typical values.

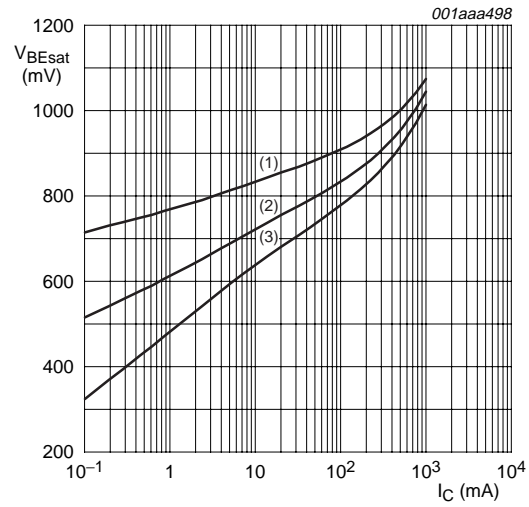

$I_C/I_B = 10$.

- (1) $T_{amb} = -55\text{ }^\circ\text{C}$.
- (2) $T_{amb} = 25\text{ }^\circ\text{C}$.
- (3) $T_{amb} = 100\text{ }^\circ\text{C}$.

Fig 8. Base-emitter saturation voltage as a function of collector current; typical values.

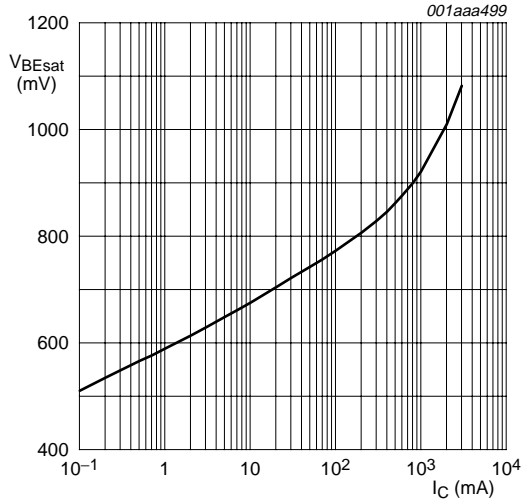

$I_C/I_B = 20$; $T_{amb} = 25\text{ }^\circ\text{C}$.

Fig 9. Base-emitter saturation voltage as a function of collector current; typical values.

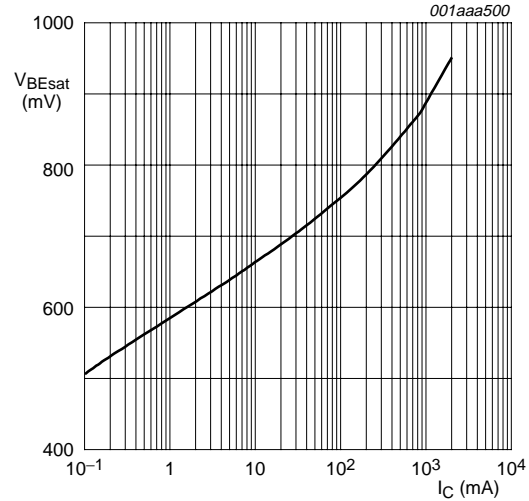

$I_C/I_B = 50$; $T_{amb} = 25\text{ }^\circ\text{C}$.

Fig 10. Base-emitter saturation voltage as a function of collector current; typical values.

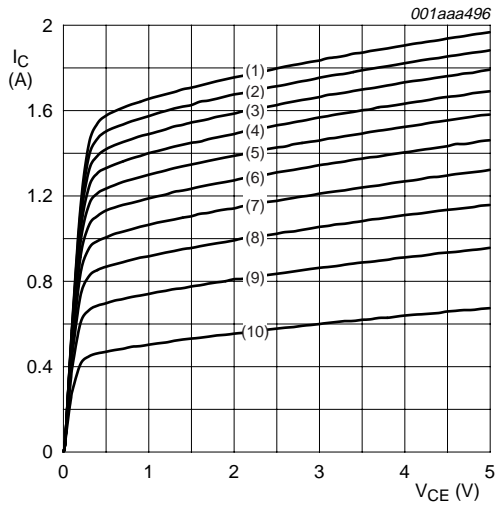

$T_{amb} = 25\text{ }^{\circ}\text{C}$.

- (1) $I_B = 35\text{ mA}$.
- (2) $I_B = 31.5\text{ mA}$.
- (3) $I_B = 28\text{ mA}$.
- (4) $I_B = 24.5\text{ mA}$.
- (5) $I_B = 21\text{ mA}$.
- (6) $I_B = 17.5\text{ mA}$.
- (7) $I_B = 14\text{ mA}$.
- (8) $I_B = 10.5\text{ mA}$.
- (9) $I_B = 7\text{ mA}$.
- (10) $I_B = 3.5\text{ mA}$.

Fig 11. Collector current as a function of collector-emitter voltage; typical values.

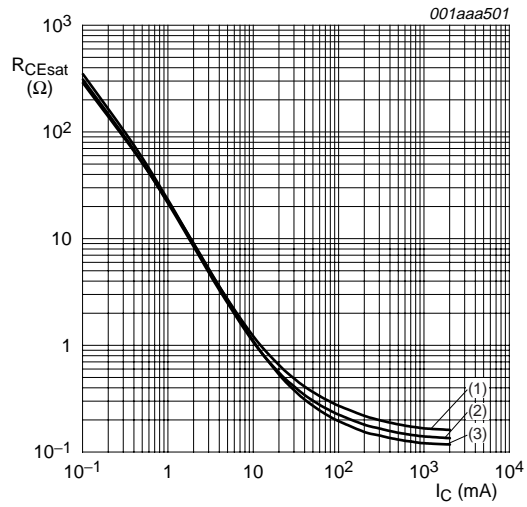

$I_C/I_B = 10$.

- (1) $T_{amb} = 100\text{ }^{\circ}\text{C}$.
- (2) $T_{amb} = 25\text{ }^{\circ}\text{C}$.
- (3) $T_{amb} = -55\text{ }^{\circ}\text{C}$.

Fig 12. Equivalent on-resistance as a function of collector current; typical values.

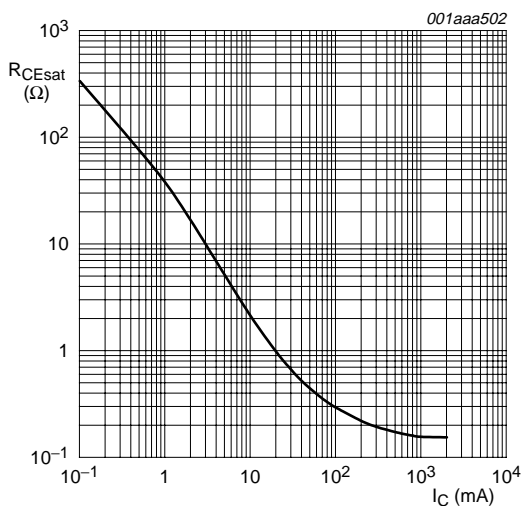

$I_C/I_B = 20$; $T_{amb} = 25\text{ }^{\circ}\text{C}$.

Fig 13. Equivalent on-resistance as a function of collector current; typical values.

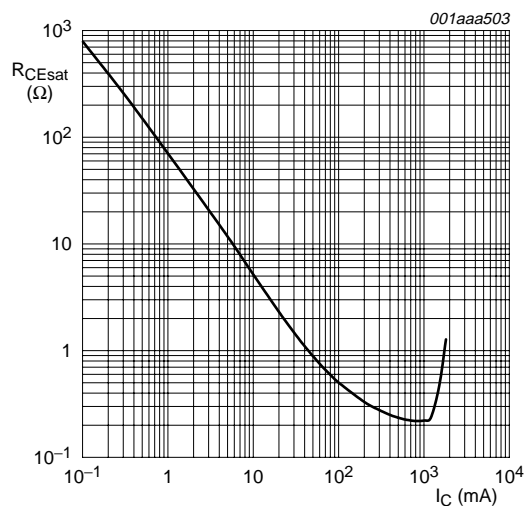

$I_C/I_B = 50$; $T_{amb} = 25\text{ }^{\circ}\text{C}$.

Fig 14. Equivalent on-resistance as a function of collector current; typical values.

8. Package outline

Plastic surface mounted package; collector pad for good heat transfer; 4 leads

SOT223

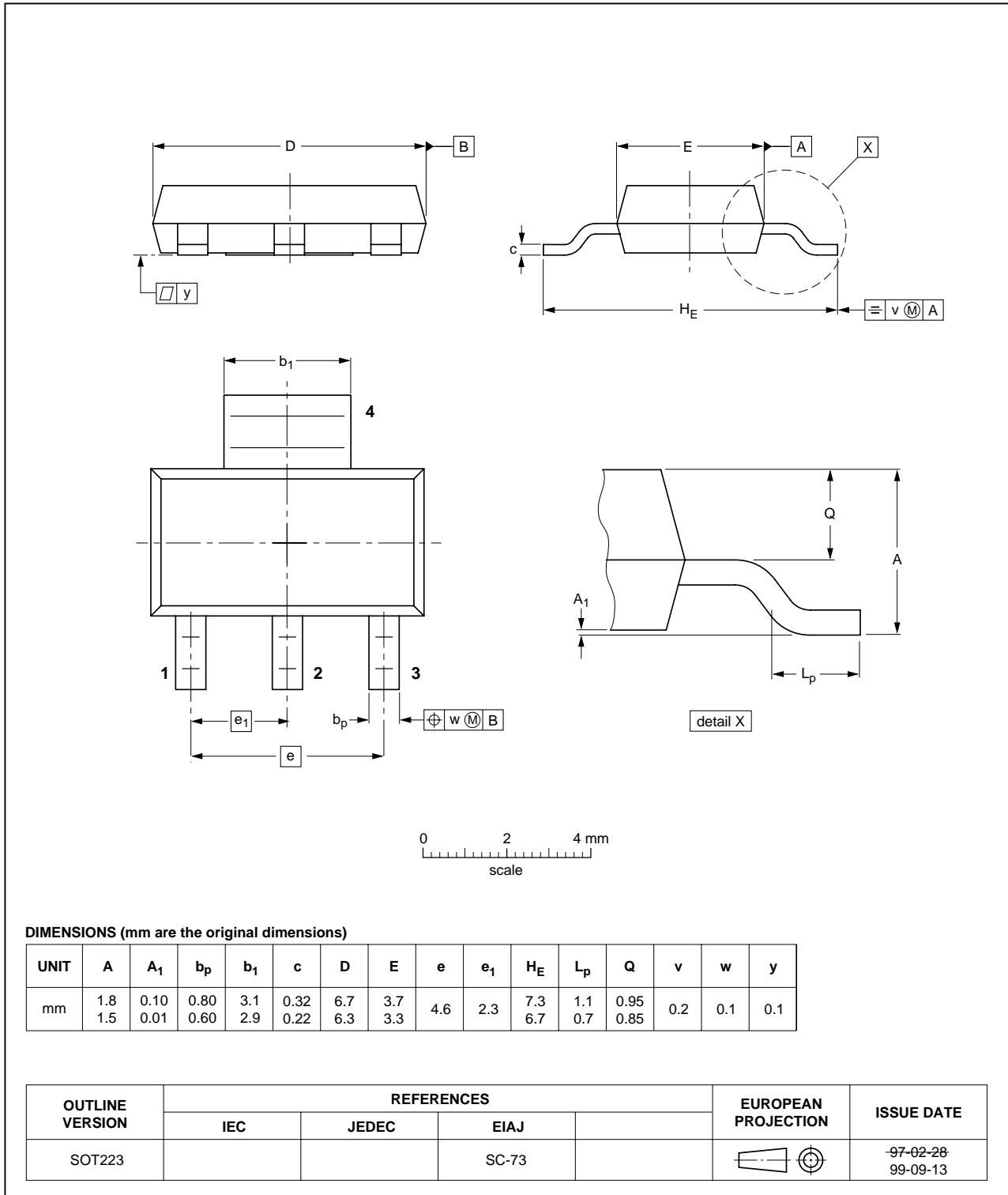

Fig 15. Package outline.

9. Revision history

Table 8: Revision history

Document ID	Release date	Data sheet status	Change notice	Order number	Supersedes
PBSS8110Z_1	20040426	Product data	-	9397 750 12568	-

10. Data sheet status

Level	Data sheet status ^[1]	Product status ^[2] ^[3]	Definition
I	Objective data	Development	This data sheet contains data from the objective specification for product development. Philips Semiconductors reserves the right to change the specification in any manner without notice.
II	Preliminary data	Qualification	This data sheet contains data from the preliminary specification. Supplementary data will be published at a later date. Philips Semiconductors reserves the right to change the specification without notice, in order to improve the design and supply the best possible product.
III	Product data	Production	This data sheet contains data from the product specification. Philips Semiconductors reserves the right to make changes at any time in order to improve the design, manufacturing and supply. Relevant changes will be communicated via a Customer Product/Process Change Notification (CPCN).

[1] Please consult the most recently issued data sheet before initiating or completing a design.

[2] The product status of the device(s) described in this data sheet may have changed since this data sheet was published. The latest information is available on the Internet at URL <http://www.semiconductors.philips.com>.

[3] For data sheets describing multiple type numbers, the highest-level product status determines the data sheet status.

11. Definitions

Short-form specification — The data in a short-form specification is extracted from a full data sheet with the same type number and title. For detailed information see the relevant data sheet or data handbook.

Limiting values definition — Limiting values given are in accordance with the Absolute Maximum Rating System (IEC 60134). Stress above one or more of the limiting values may cause permanent damage to the device. These are stress ratings only and operation of the device at these or at any other conditions above those given in the Characteristics sections of the specification is not implied. Exposure to limiting values for extended periods may affect device reliability.

Application information — Applications that are described herein for any of these products are for illustrative purposes only. Philips Semiconductors make no representation or warranty that such applications will be suitable for the specified use without further testing or modification.

12. Disclaimers

Life support — These products are not designed for use in life support appliances, devices, or systems where malfunction of these products can reasonably be expected to result in personal injury. Philips Semiconductors customers using or selling these products for use in such applications do so at their own risk and agree to fully indemnify Philips Semiconductors for any damages resulting from such application.

Right to make changes — Philips Semiconductors reserves the right to make changes in the products - including circuits, standard cells, and/or software - described or contained herein in order to improve design and/or performance. When the product is in full production (status 'Production'), relevant changes will be communicated via a Customer Product/Process Change Notification (CPCN). Philips Semiconductors assumes no responsibility or liability for the use of any of these products, conveys no license or title under any patent, copyright, or mask work right to these products, and makes no representations or warranties that these products are free from patent, copyright, or mask work right infringement, unless otherwise specified.

13. Contact information

For additional information, please visit: <http://www.semiconductors.philips.com>

For sales office addresses, send an email to: sales.addresses@www.semiconductors.philips.com

14. Contents

1	Product profile	1
1.1	General description	1
1.2	Features	1
1.3	Applications	1
1.4	Quick reference data	1
2	Pinning information	2
3	Ordering information	2
4	Marking	2
5	Limiting values	3
6	Thermal characteristics	4
7	Characteristics	5
8	Package outline	9
9	Revision history	10
10	Data sheet status	11
11	Definitions	11
12	Disclaimers	11
13	Contact information	11



© Koninklijke Philips Electronics N.V. 2004

All rights are reserved. Reproduction in whole or in part is prohibited without the prior written consent of the copyright owner. The information presented in this document does not form part of any quotation or contract, is believed to be accurate and reliable and may be changed without notice. No liability will be accepted by the publisher for any consequence of its use. Publication thereof does not convey nor imply any license under patent- or other industrial or intellectual property rights.

Date of release: 26 April 2004
Document order number: 9397 750 12568

Published in The Netherlands