

# Single Phase Rectifier Bridge

**$I_{dAVM} = 107 \text{ A}$**   
 **$V_{RRM} = 1200-1800 \text{ V}$**

$V_{RSM}$ V	$V_{RRM}$ V	Type
900	800	VBO 105-08NO7
1200	1200	VBO 105-12NO7
1400	1400	VBO 105-14NO7
1600	1600	VBO 105-16NO7
1800	1800	VBO 105-18NO7*

\* delivery time on request

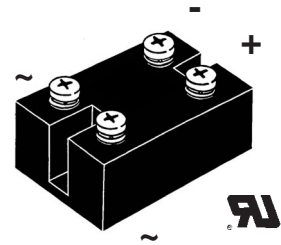
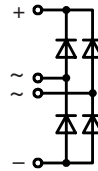

Symbol	Conditions	Maximum Ratings	
$I_{dAVM}$	$T_C = 85^\circ\text{C}$ , module	107	A
$I_{FSM}$	$T_{VJ} = 45^\circ\text{C};$ $V_R = 0$	$t = 10 \text{ ms}$ (50 Hz), sine	1500 A
		$t = 8.3 \text{ ms}$ (60 Hz), sine	1650 A
$I^2t$	$T_{VJ} = T_{VJM}$ $V_R = 0$	$t = 10 \text{ ms}$ (50 Hz), sine	1350 A
		$t = 8.3 \text{ ms}$ (60 Hz), sine	1500 A
$I^2t$	$T_{VJ} = 45^\circ\text{C}$ $V_R = 0$	$t = 10 \text{ ms}$ (50 Hz), sine	11250 A <sup>2</sup> s
		$t = 8.3 \text{ ms}$ (60 Hz), sine	11300 A <sup>2</sup> s
$T_{VJ}$		-40...+150	$^\circ\text{C}$
$T_{VJM}$		150	$^\circ\text{C}$
$T_{stg}$		-40...+150	$^\circ\text{C}$
$V_{ISOL}$	50/60 Hz, RMS $I_{ISOL} \leq 1 \text{ mA}$	$t = 1 \text{ min}$	2500 V~
		$t = 1 \text{ s}$	3000 V~
$M_d$	Mounting torque (M5)  Terminal connection torque (M5)	5 $\pm$ 15%	Nm
		44 $\pm$ 15%	lb.in.
$M_d$	Mounting torque (M5)  Terminal connection torque (M5)	5 $\pm$ 15%	Nm
		44 $\pm$ 15%	lb.in.
Weight	typ.	225	g

## Features

- Package with screw terminals
- Isolation voltage 3000 V~
- Planar passivated chips
- Blocking voltage up to 1800 V
- Low forward voltage drop
- UL registered E 72873

## Applications

- Supplies for DC power equipment
- Input rectifiers for PWM inverter
- Battery DC power supplies
- Field supply for DC motors

## Advantages

- Easy to mount with two screws
- Space and weight savings
- Improved temperature and power cycling

## Dimensions in mm (1 mm = 0.0394")

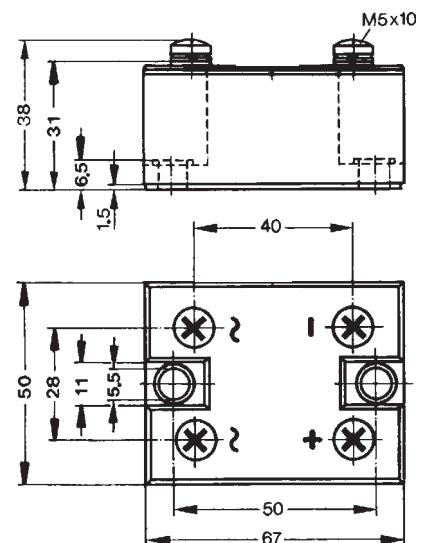

Symbol	Conditions	Characteristic Values	
$I_R$	$V_R = V_{RRM};$ $V_R = V_{RRM};$	$T_{VJ} = 25^\circ\text{C}$	$\leq 0.3 \text{ mA}$
		$T_{VJ} = T_{VJM}$	$\leq 8.0 \text{ mA}$
$V_F$	$I_F = 150 \text{ A};$ $T_{VJ} = 25^\circ\text{C}$	$\leq 1.6$	V
$V_{T0}$	For power-loss calculations only	0.8	V
$r_T$	$T_{VJ} = T_{VJM}$	5	m $\Omega$
$R_{thJC}$	per diode; 180°	0.83	K/W
	per module; 180°	0.138	K/W
$R_{thJK}$	per diode; 180°	1.13	K/W
	per module; 180°	0.188	K/W

Data according to IEC 60747 refer to a single diode unless otherwise stated.

IXYS reserves the right to change limits, test conditions and dimensions.

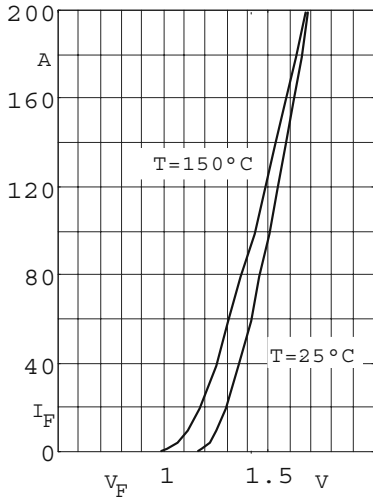

Fig. 1 Forward current versus voltage drop per diode

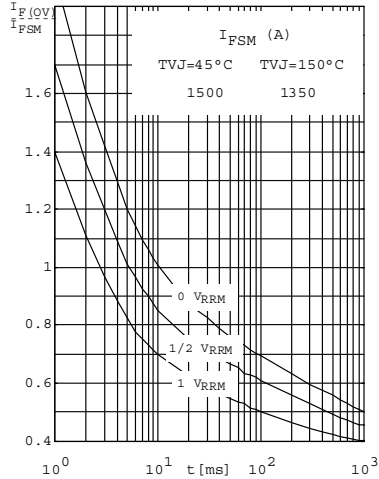

Fig. 2 Surge overload current per diode  $I_{FSM}$ : Crest value.  $t$ : duration

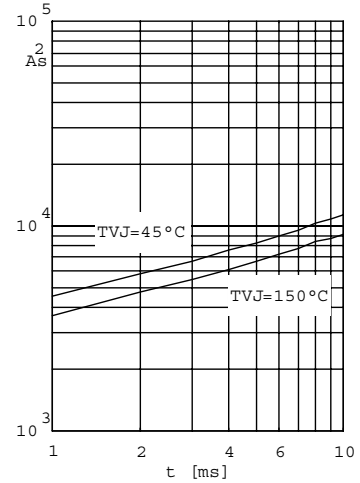

Fig. 3  $\int i^2 dt$  versus time (1-10ms) per diode or thyristor

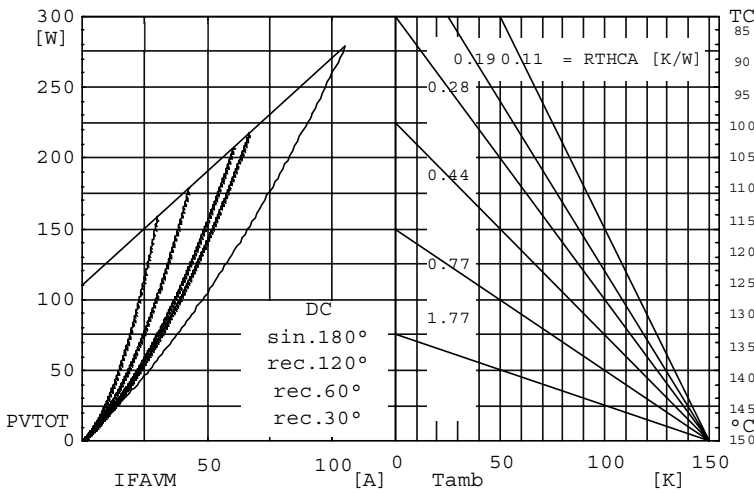

Fig. 4 Power dissipation versus direct output current and ambient temperature

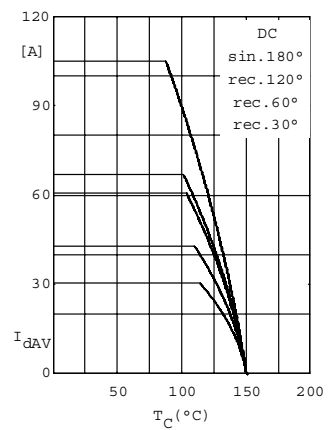

Fig.5 Maximum forward current at case temperature

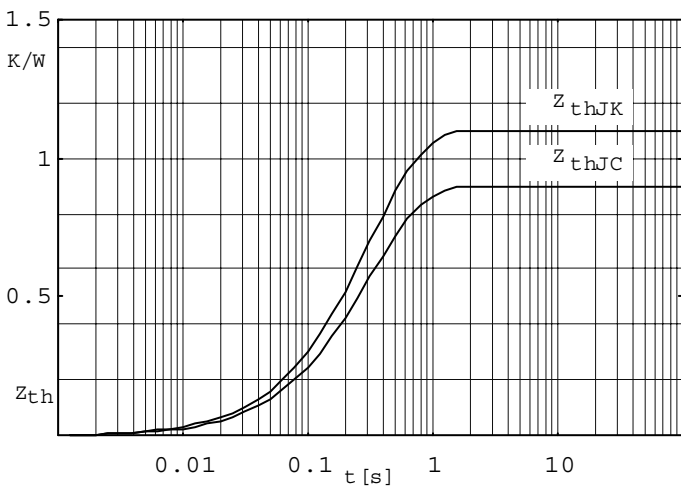

Fig. 6 Transient thermal impedance per diode or thyristor, calculated