

*RoHS COMPLIANT

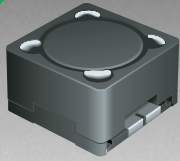

BOURNS®

Features

- E6 series optional
- Unit height of 5.5 mm
- Current up to 5 A
- J-hook leads
- RoHS compliant*

Applications

- Input/output of DC/DC converters
- Power supplies for:
 - Portable communication equipment
 - Camcorders
 - LCD TVs
 - Car radios

SRR1205 Series - Shielded High Power Inductors

Electrical Specifications

Bourns Part No.	Inductance 1kHz		Q Ref.	Test Frequency (MHz)	SRF Min. (MHz)	RDC (mΩ)	I rms Max. (A)	I sat Typ. (A)
	(μH)	Tol. %						
SRR1205-2R5ML	2.5	± 20	18	7.96M	27.0	24	5.00	10.00
SRR1205-3R3ML	3.3	± 20	20	7.96M	25.0	30	4.50	9.20
SRR1205-5R0ML	5.0	± 20	20	7.96M	21.0	35	4.00	8.20
SRR1205-7R5ML	7.5	± 20	20	7.96M	17.0	40	3.50	7.80
SRR1205-100ML	10	± 20	21	2.52M	15.0	54	3.00	6.00
SRR1205-120ML	12	± 20	20	2.52M	13.0	65	2.80	5.60
SRR1205-150ML	15	± 20	20	2.52M	11.0	70	2.70	5.30
SRR1205-180ML	18	± 20	20	2.52M	10.0	82	2.60	4.80
SRR1205-220ML	22	± 20	19	2.52M	9.0	95	2.40	4.60
SRR1205-270ML	27	± 20	18	2.52M	8.0	120	2.00	4.00
SRR1205-330ML	33	± 20	18	2.52M	8.0	145	1.80	3.50
SRR1205-390ML	39	± 20	18	2.52M	7.5	160	1.65	3.20
SRR1205-500YL	50	± 15	18	2.52M	7.0	200	1.50	2.80
SRR1205-560YL	56	± 15	18	2.52M	7.0	240	1.40	2.50
SRR1205-680YL	68	± 15	17	2.52M	6.5	280	1.30	2.40
SRR1205-750YL	75	± 15	17	2.52M	6.0	330	1.20	2.20
SRR1205-101KL	100	± 10	12	0.796M	5.0	400	1.00	2.00
SRR1205-121KL	120	± 10	10	0.796M	4.5	500	0.90	1.60
SRR1205-151KL	150	± 10	10	0.796M	4.0	580	0.80	1.50
SRR1205-181KL	180	± 10	9	0.796M	3.5	750	0.70	1.40
SRR1205-221KL	220	± 10	9	0.796M	3.0	840	0.65	1.30
SRR1205-271KL	270	± 10	9	0.796M	2.5	1000	0.60	1.00
SRR1205-331KL	330	± 10	7	0.796M	2.0	1340	0.54	0.88
SRR1205-391KL	390	± 10	7	0.796M	2.0	1500	0.50	0.80
SRR1205-471KL	470	± 10	7	0.796M	2.0	1980	0.45	0.72
SRR1205-561KL	560	± 10	6	0.796M	1.5	2200	0.40	0.65
SRR1205-681KL	680	± 10	6	0.796M	1.5	2400	0.35	0.60
SRR1205-821KL	820	± 10	5	0.796M	1.0	3000	0.30	0.57

General Specifications

Test Voltage.....1 V
 Reflow Soldering ...230 °C, 50 sec. max.
 Operating Temperature ..-40 °C to +125 °C
 (Temperature rise included)
 Storage Temperature...-40 °C to +125 °C
 Resistance to Soldering Heat
260 °C for 5 sec.

Materials

Core.....Ferrite DR and RI core
 Wire.....Enameled copper
 Base.....LCP E4008
 Terminal.....Cu/Ni/Sn
 Rated Current
Ind. drop 10 % typ. at Isat
 Temperature Rise
40 °C max. at rated I rms
 Packaging.....600 pcs. per reel

Product Dimensions

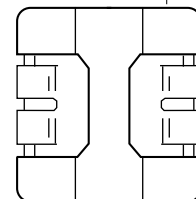
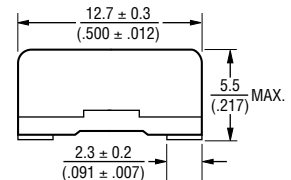
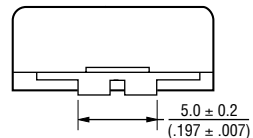
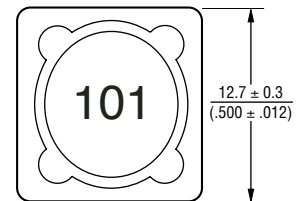

DIMENSIONS: $\frac{\text{MM}}{\text{(INCHES)}}$

Electrical Schematic

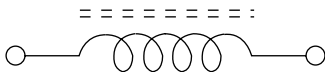

Recommended Layout

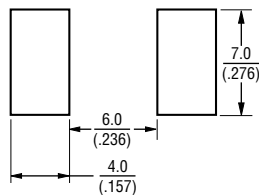

SRR1205 Series - Shielded High Power Inductors

BOURNS®

Packaging Specifications

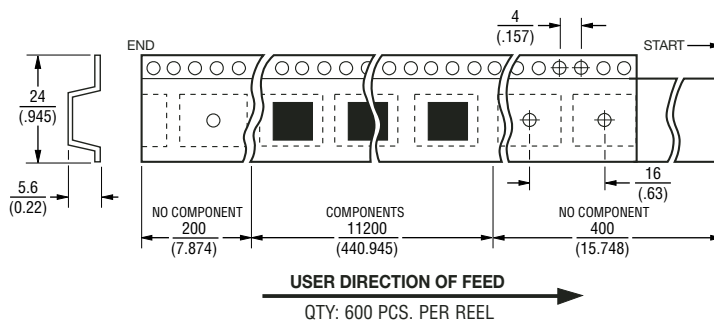
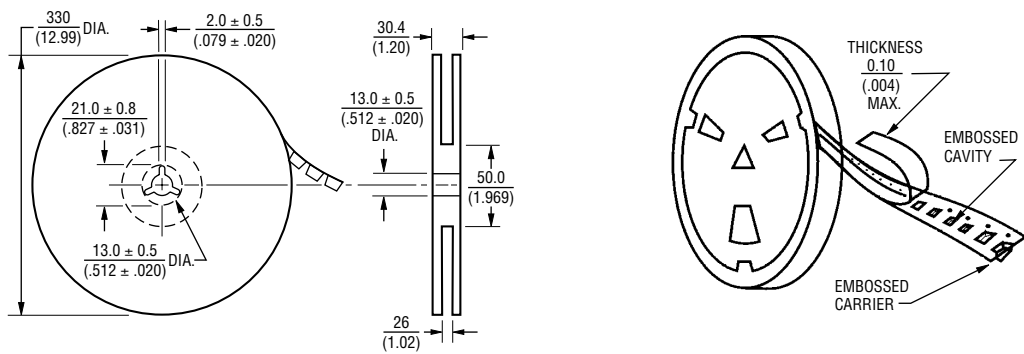

DIMENSIONS: $\frac{\text{MM}}{\text{(INCHES)}}$

REV. 05/05

Specifications are subject to change without notice.
Customers should verify actual device performance in their specific applications.