

HiPerFAST™ IGBT IXGH 24N60BU1 with Diode

$V_{CES} = 600 \text{ V}$
 $I_{C25} = 48 \text{ A}$
 $V_{CE(sat)} = 2.3 \text{ V}$
 $t_{fi} = 80 \text{ ns}$

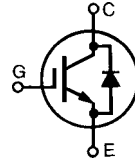

Symbol	Test Conditions	Maximum Ratings	
V_{CES}	$T_J = 25^\circ\text{C to } 150^\circ\text{C}$	600	V
V_{CGR}	$T_J = 25^\circ\text{C to } 150^\circ\text{C}; R_{GE} = 1 \text{ M}\Omega$	600	V
V_{GES}	Continuous	± 20	V
V_{GEM}	Transient	± 30	V
I_{C25}	$T_C = 25^\circ\text{C}$	48	A
I_{C90}	$T_C = 90^\circ\text{C}$	24	A
I_{CM}	$T_C = 25^\circ\text{C}, 1 \text{ ms}$	96	A
SSOA (RBSOA)	$V_{GE} = 15 \text{ V}, T_{VJ} = 125^\circ\text{C}, R_G = 22 \Omega$ Clamped inductive load, $L = 100 \mu\text{H}$	$I_{CM} = 48$ @ $0.8 V_{CES}$	A
P_C	$T_C = 25^\circ\text{C}$	150	W
T_J		-55 ... +150	$^\circ\text{C}$
T_{JM}		150	$^\circ\text{C}$
T_{stg}		-55 ... +150	$^\circ\text{C}$
Maximum Lead and Tab temperature for soldering 1.6 mm (0.062 in.) from case for 10 s		300	$^\circ\text{C}$
M_d	Mounting torque	1.13/10	Nm/lb.in.
Weight		6	g

TO-247 AD

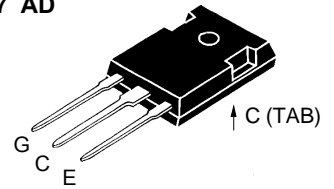

G = Gate C = Collector
 E = Emitter TAB = Collector

Features

- High frequency IGBT and antiparallel FRED in one package
- High current handling capability
- 3rd generation HDMOST™ process
- MOS Gate turn-on
- drive simplicity

Applications

- AC motor speed control
- DC servo and robot drives
- DC choppers
- Uninterruptible power supplies (UPS)
- Switched-mode and resonant-mode power supplies

Advantages

- Space savings (two devices in one package)
- High power density
- Suitable for surface mounting
- Switching speed for high frequency applications
- Easy to mount with 1 screw (insulated mounting screw hole)

Symbol	Test Conditions	Characteristic Values ($T_J = 25^\circ\text{C}$, unless otherwise specified)		
		min.	typ.	max.
BV_{CES}	$I_C = 750 \mu\text{A}, V_{GE} = 0 \text{ V}$	600		V
$V_{GE(th)}$	$I_C = 250 \mu\text{A}, V_{CE} = V_{GE}$	2.5		5.5 V
I_{CES}	$V_{CE} = 0.8 \cdot V_{CES}$ $V_{GE} = 0 \text{ V}$			$T_J = 25^\circ\text{C}$ $T_J = 125^\circ\text{C}$ 500 μA 8 mA
I_{GES}	$V_{CE} = 0 \text{ V}, V_{GE} = \pm 20 \text{ V}$			$\pm 100 \text{ nA}$
$V_{CE(sat)}$	$I_C = I_{C90}, V_{GE} = 15 \text{ V}$			2.3 V

Symbol	Test Conditions	Characteristic Values ($T_J = 25^\circ\text{C}$, unless otherwise specified)				
		min.	typ.	max.		
g_{fs}	$I_C = I_{C90}, V_{CE} = 10\text{ V}$, Pulse test, $t \leq 300\ \mu\text{s}$, duty cycle $\leq 2\%$	9	13	S		
C_{ies} C_{oes} C_{res}	$V_{CE} = 25\text{ V}, V_{GE} = 0\text{ V}, f = 1\text{ MHz}$		1500	pF		
			175	pF		
			40	pF		
Q_G Q_{GE} Q_{GC}	$I_C = I_{C90}, V_{GE} = 15\text{ V}, V_{CE} = 0.5 V_{CES}$		90	nC		
			11	15	nC	
			30	40	nC	
$t_{d(on)}$ t_{ri} E_{on} $t_{d(off)}$ t_{fi} E_{off}	Inductive load, $T_J = 25^\circ\text{C}$ $I_C = I_{C90}, V_{GE} = 15\text{ V}, L = 100\ \mu\text{H}$, $V_{CE} = 0.8 V_{CES}, R_G = R_{off} = 10\ \Omega$ Remarks: Switching times may increase for V_{CE} (Clamp) $> 0.8 \cdot V_{CES}$, 24N60BU1 higher T_J or increased R_G		25	ns		
				15	ns	
				0.6	mJ	
				150	200	ns
				80	150	ns
				0.8	mJ	
$t_{d(on)}$ t_{ri} E_{on} $t_{d(off)}$ t_{fi} E_{off}	Inductive load, $T_J = 125^\circ\text{C}$ $I_C = I_{C90}, V_{GE} = 15\text{ V}, L = 100\ \mu\text{H}$ $V_{CE} = 0.8 V_{CES}, R_G = R_{off} = 10\ \Omega$ 24N60BU1		25	ns		
				15	ns	
				0.8	mJ	
				250	ns	
				100	ns	
				1.4	mJ	
R_{thJC} R_{thCK}				0.83 K/W K/W		

TO-247 AD Outline

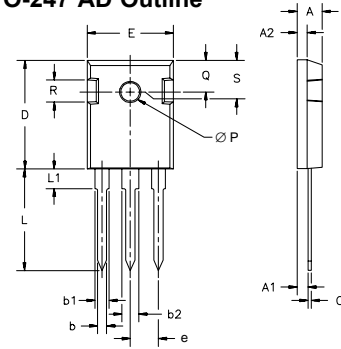

Dim.	Millimeter		Inches	
	Min.	Max.	Min.	Max.
A	4.7	5.3	.185	.209
A ₁	2.2	2.54	.087	.102
A ₂	2.2	2.6	.059	.098
b	1.0	1.4	.040	.055
b ₁	1.65	2.13	.065	.084
b ₂	2.87	3.12	.113	.123
C	.4	.8	.016	.031
D	20.80	21.46	.819	.845
E	15.75	16.26	.610	.640
e	5.20	5.72	0.205	0.225
L	19.81	20.32	.780	.800
L ₁		4.50		.177
ØP	3.55	3.65	.140	.144
Q	5.89	6.40	0.232	0.252
R	4.32	5.49	.170	.216
S	6.15	BSC	.242	BSC

Symbol	Test Conditions	Characteristic Values ($T_J = 25^\circ\text{C}$, unless otherwise specified)				
		min.	typ.	max.		
V_F	$I_F = I_{C90}, V_{GE} = 0\text{ V}$, Pulse test, $t \leq 300\ \mu\text{s}$, duty cycle $d \leq 2\%$			1.6 V		
I_{RM} t_{tr}	$I_F = I_{C90}, V_{GE} = 0\text{ V}, -di_F/dt = 240\text{ A}/\mu\text{s}$ $V_R = 360\text{ V}$ $I_F = 1\text{ A}; -di/dt = 100\text{ A}/\mu\text{s}; V_R = 30\text{ V}$		10	15	A	
				150		ns
				35	50	ns
R_{thJC}				1	K/W	

Min. Recommended Footprint (Dimensions in inches and (mm))

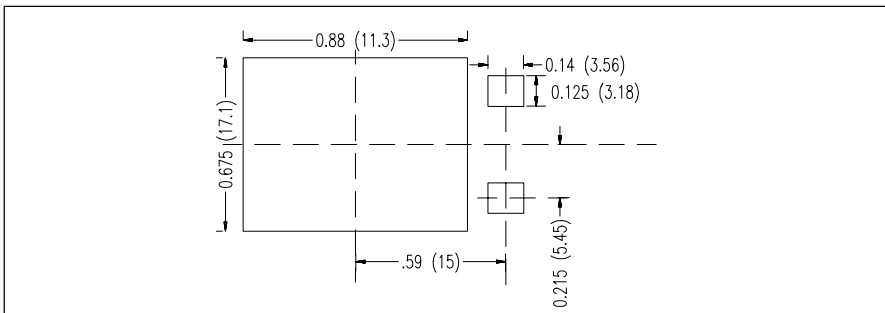

IXYS reserves the right to change limits, test conditions, and dimensions.

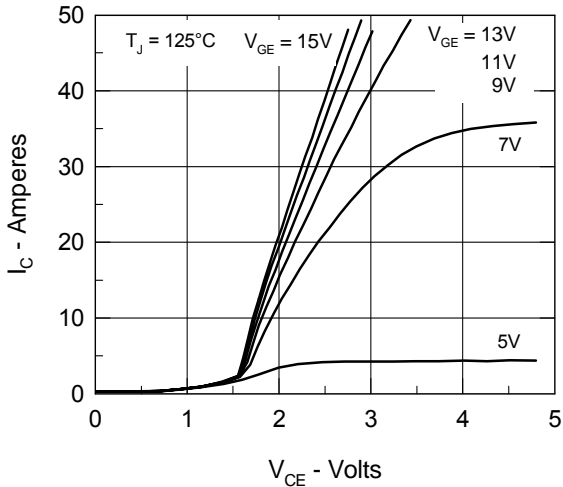

Fig. 1. Saturation Voltage Characteristics

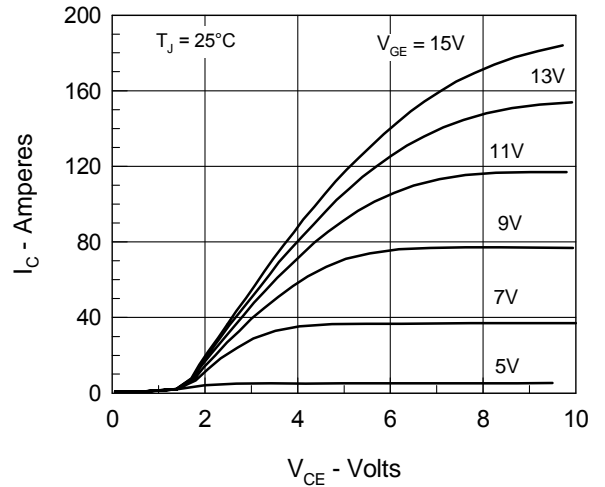

Fig. 2. Extended Output Characteristics

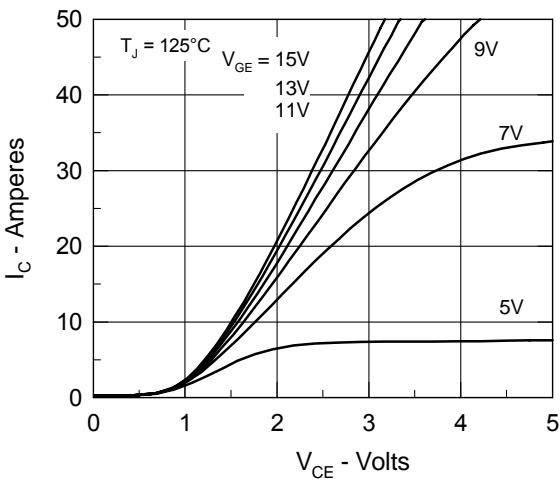

Fig. 3. Saturation Voltage Characteristics

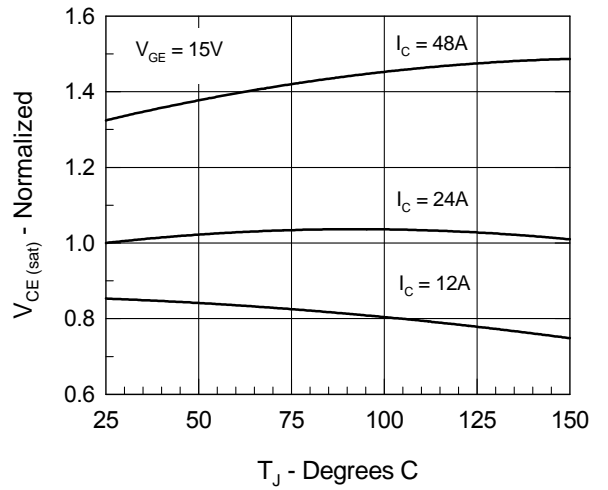

Fig. 4. Temperature Dependence of $V_{CE(sat)}$

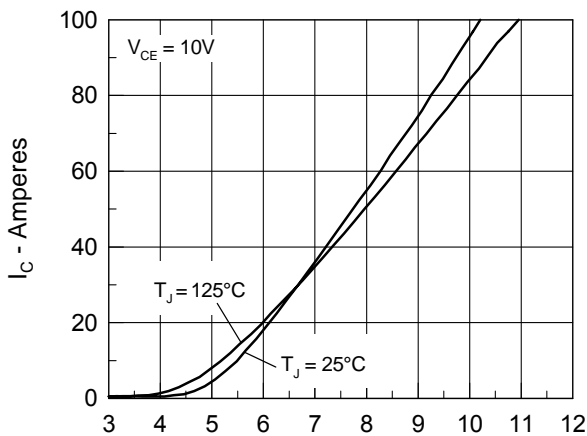

Fig. 5. Admittance Curves

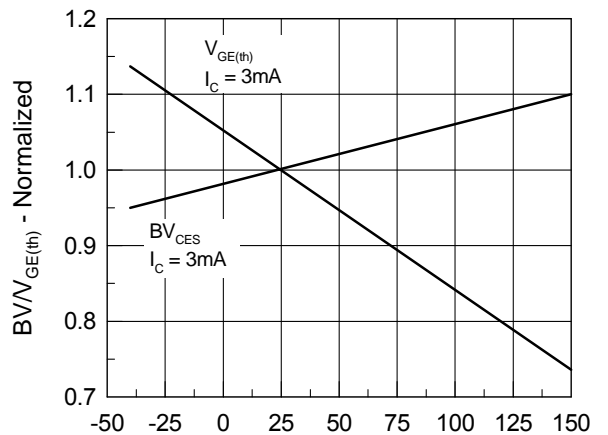

Fig. 6. Temperature Dependence of BV_{DSS} & $V_{GE(th)}$

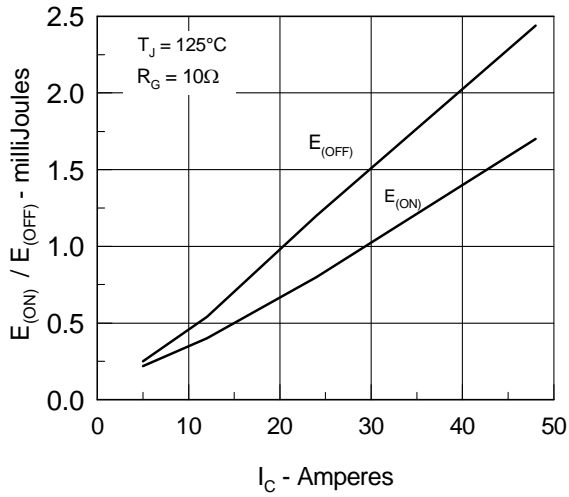

Fig. 7. Dependence of t_{fi} and E_{OFF} on I_C.

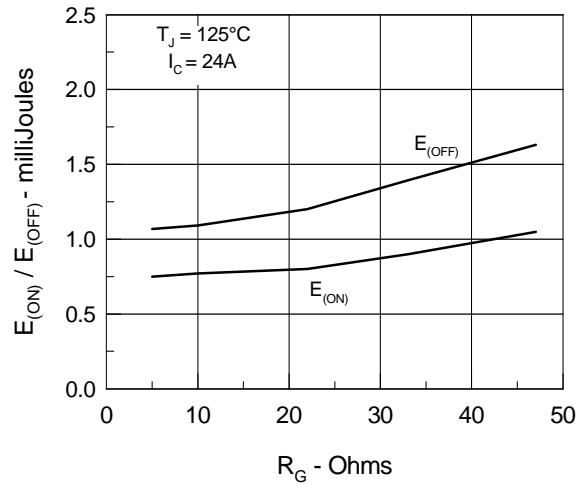

Fig. 8. Dependence of t_{fi} and E_{OFF} on R_G.

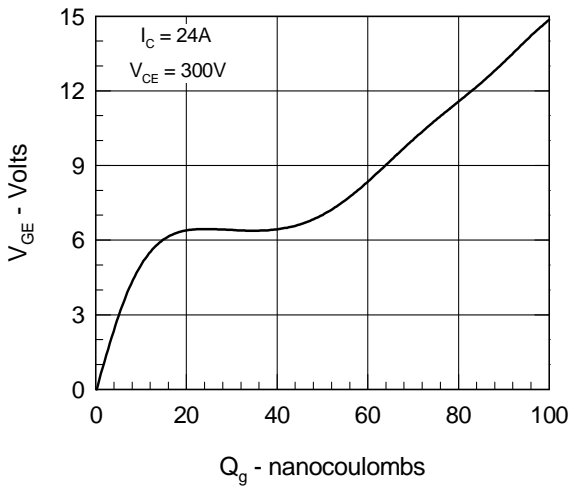

Fig. 9. Gate Charge

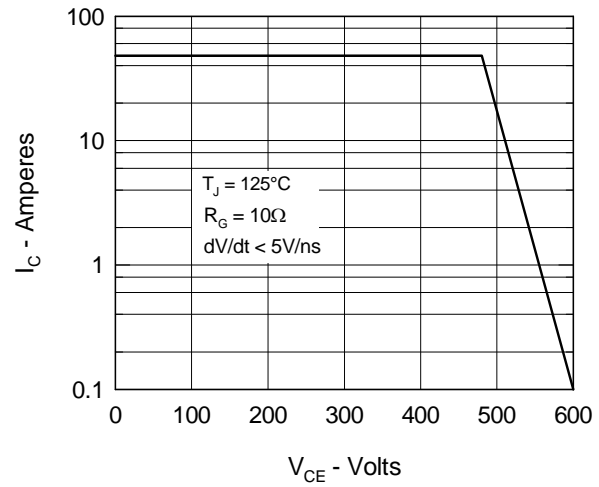

Fig. 10. Turn-off Safe Operating Area

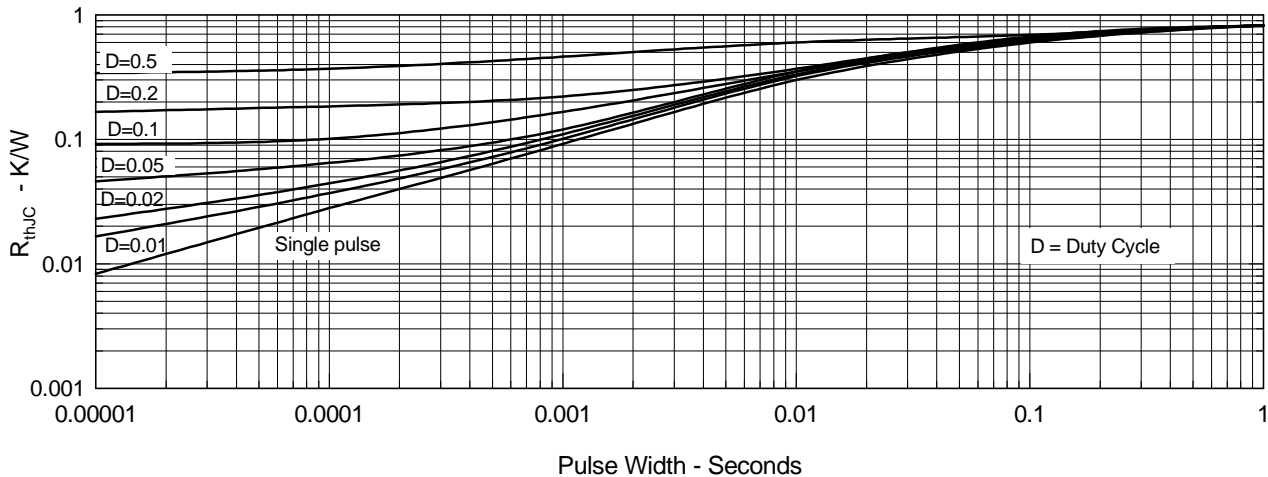

Fig. 11. Transient Thermal Resistance

IXYS reserves the right to change limits, test conditions, and dimensions.

IXYS MOSFETS and IGBTs are covered by one or more of the following U.S. patents:

4,835,592	4,881,106	5,017,508	5,049,961	5,187,117	5,486,715	6,306,728B1
4,850,072	4,931,844	5,034,796	5,063,307	5,237,481	5,381,025	

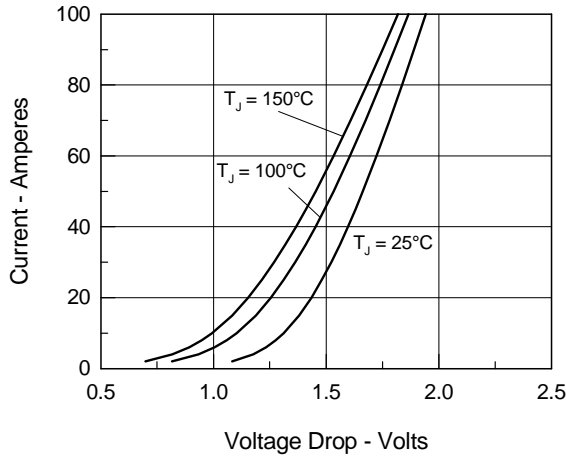

Fig.12 Maximum Forward Voltage Drop

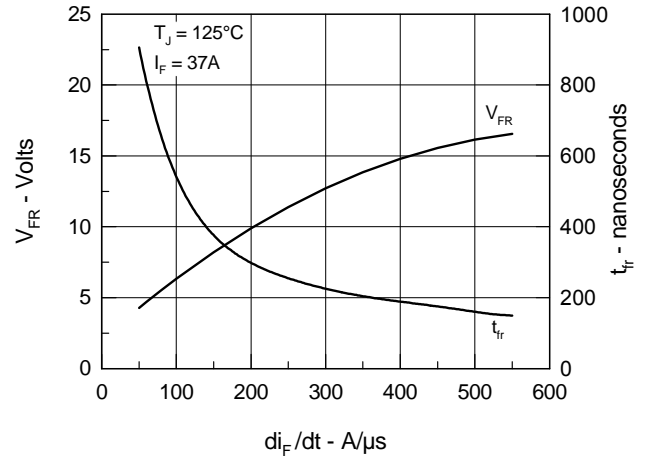

Fig.13 Peak Forward Voltage V_{FR} and Forward Recovery Time t_{FR}

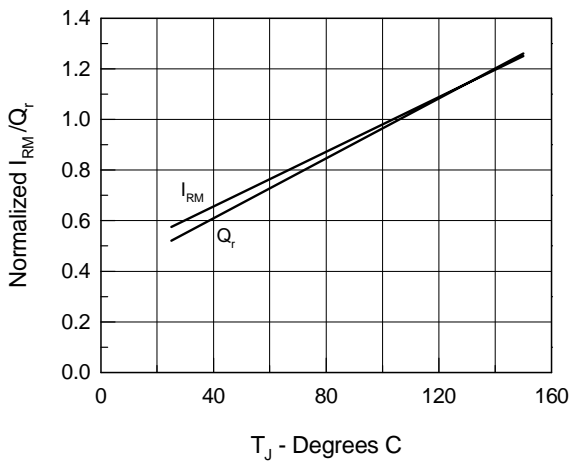

Fig.14 Junction Temperature Dependence of I_{RM} and Q_r

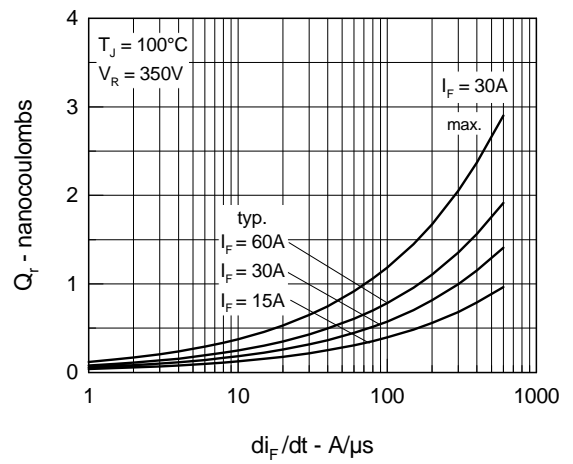

Fig.15 Reverse Recovery Charge

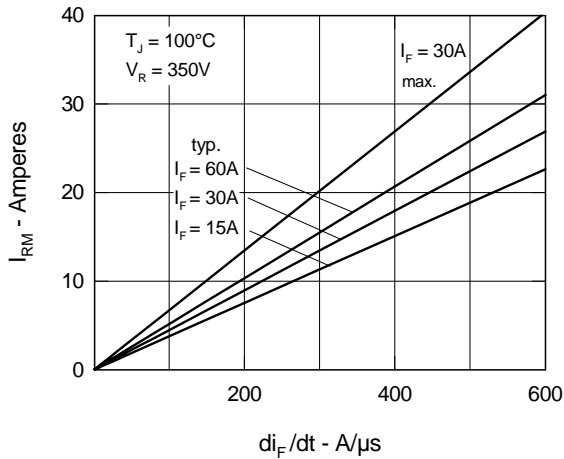

Fig.16 Peak Reverse Recovery Current

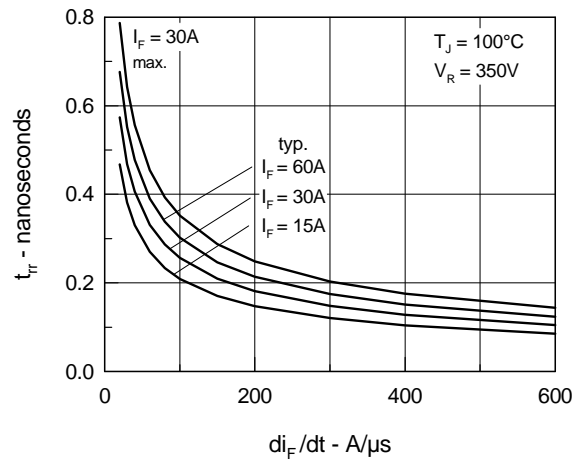

Fig.17 Reverse Recovery Time

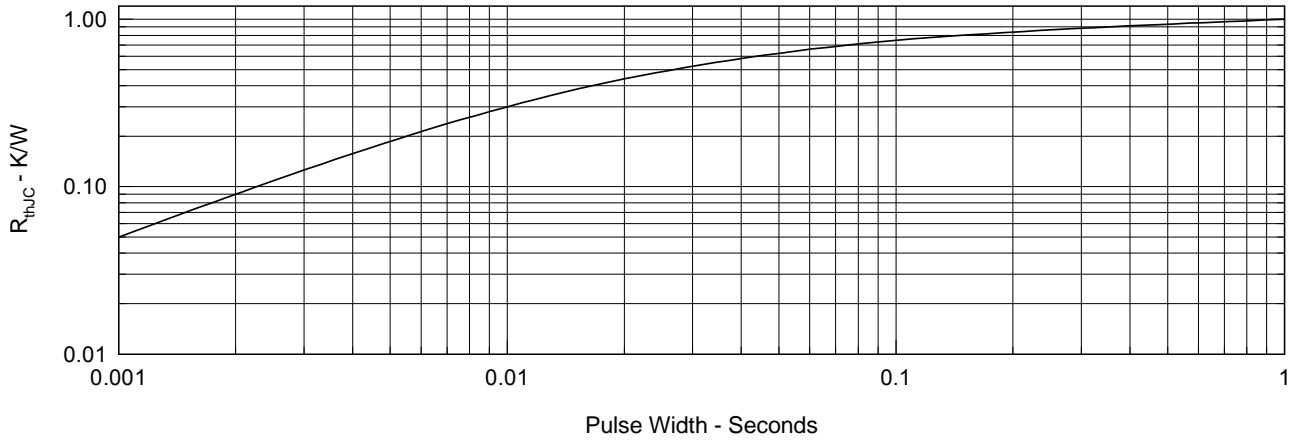

Fig.18 Diode Transient Thermal resistance junction to case