

1.50mm (0.059") PITCH CONNECTOR



Wire-to-Board
Wafer

15001WR Series

SMT

Right Angle

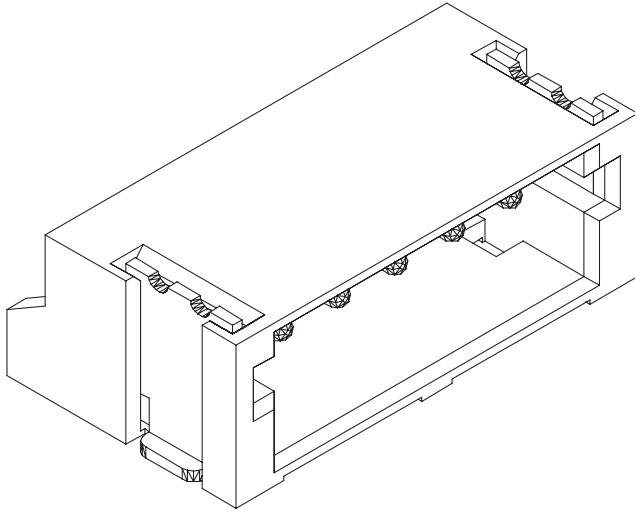

Material

I/NO	DESCRIPTION	TITLE	MATERIAL
1	WAFER	15001WR	PA6T or PA46, UL 94V Grade
2	PIN		BRASS & Tin plated
3	HOOK	15001LR	BRASS & Tin plated

Available Pin

PARTS NO.	A	B	C
15001WR-02A00	6.0	3.6	1.5
15001WR-03A00	7.5	5.1	3.0
15001WR-04A00	9.0	6.6	4.5
15001WR-05A00	10.5	8.1	6.0
15001WR-06A00	12.0	9.6	7.5
15001WR-07A00	13.5	11.1	9.0
15001WR-08A00	15.0	12.6	10.5
15001WR-09A00	16.5	14.1	12.0
15001WR-10A00	18.0	15.6	13.5
15001WR-11A00	19.5	17.1	15.0
15001WR-12A00	21.0	18.6	16.5
15001WR-13A00	22.5	20.1	18.0

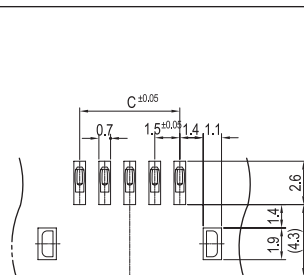
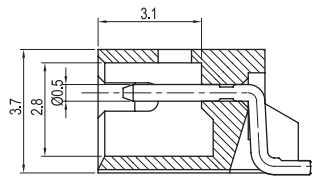
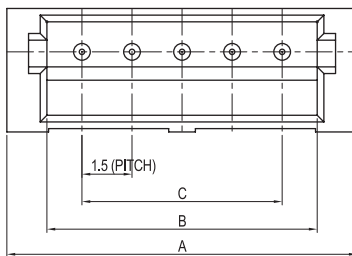
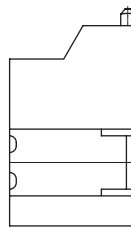
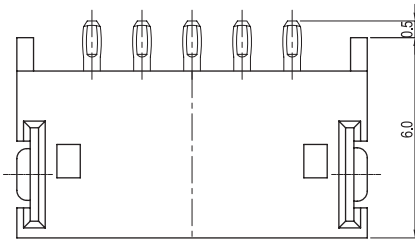

P.C.B Layout

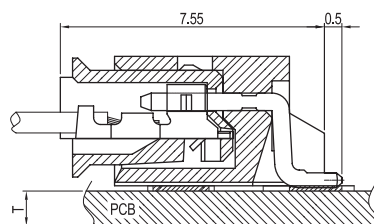

PCB ASS'Y

Specification

ITEM	SPEC
Voltage Rating	AC/DC 50V
Current Rating	AC/DC 1A
Operating Temperature	-25°C~+85°C
Contact Resistance	30mΩ MAX
Withstanding Voltage	AC500V/1min
Insulation Resistance	500MΩ MIN
Applicable Wire	-
Applicable P.C.B	0.8~1.6mm
Applicable FPC/FFC	-
Solder Height	0.15mm
Crimp Tensile Strength	-
UL FILE NO	-