

Product Description

Stanford Microdevices' SNA-200 is a GaAs monolithic broadband amplifier (MMIC) in die form. This amplifier provides 16dB of gain when biased at 50mA and 4V.

External DC decoupling capacitors determine low frequency response. The use of an external resistor allows for bias flexibility and stability.

These unconditionally stable amplifiers are designed for use as general purpose 50 ohm gain blocks. Also available in packaged form (SNA-276, -286 & -287), its small size (0.33mm x 0.33mm) and gold metallization make it an ideal choice for use in hybrid circuits.

The SNA-200 is available in gel paks at 100 devices per container.

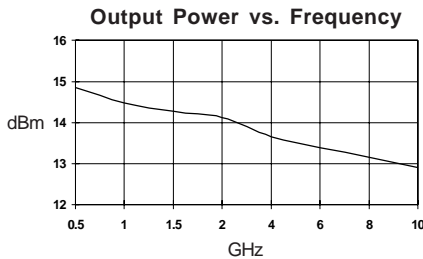

Electrical Specifications at Ta = 25° C

Symbol	Parameters: Test Conditions: Id = 50 mA, Z ₀ = 50 Ohms		Units	Min.	Typ.	Max.
G _p	Small Signal Power Gain	f = 0.1-2.0 GHz f = 2.0-4.0 GHz f = 4.0-6.5 GHz	dB	15.0 14.0 13.0	16.0 15.0 14.0	
G _F	Gain Flatness	f = 0.1-4.0 GHz	dB		+/-1.0	
BW _{3dB}	3dB Bandwidth		GHz		6.5	
P _{1dB}	Output Power at 1dB Compression	f = 2.0 GHz	dBm		14.0	
NF	Noise Figure	f = 2.0 GHz	dB		5.5	6.0
VSWR	Input/Output	f = 0.1-6.5 GHz	-		1.5:1	
IP ₃	Third Order Intercept Point	f = 2.0 GHz	dBm		27.0	
T _D	Group Delay	f = 2.0 GHz	psec		100	
ISOL	Reverse Isolation	f = 0.1-6.5 GHz	dB		20	
V _D	Device Voltage		V	3.5	4.0	4.5
dG/dT	Device Gain Temperature Coefficient		dB/degC		-0.0018	
dV/dT	Device Voltage Temperature Coefficient		mV/degC		-4.0	

The information provided herein is believed to be reliable at press time. Stanford Microdevices assumes no responsibility for inaccuracies or omissions. Stanford Microdevices assumes no responsibility for the use of this information, and all such information shall be entirely at the user's own risk. Prices and specifications are subject to change without notice. No patent rights or licenses to any of the circuits described herein are implied or granted to any third party. Stanford Microdevices does not authorize or warrant any Stanford Microdevices product for use in life-support devices and/or systems.

Copyright 1999 Stanford Microdevices, Inc. All worldwide rights reserved.

522 Almanor Ave., Sunnyvale, CA 94086

Phone: (800) SMI-MMIC

<http://www.stanfordmicro.com>

SNA-200

DC-6.5 GHz, Cascadable GaAs MMIC Amplifier

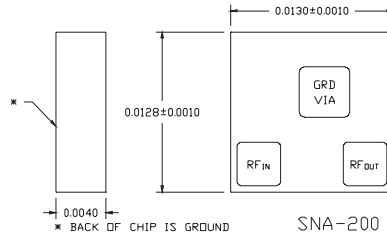

Product Features

- Cascadable 50 Ohm Gain Block
- 16dB Gain, +14dBm P1dB
- 1.5:1 Input and Output VSWR
- Operates From Single Supply
- Chip Back Is Ground

Applications

- Narrow and Broadband Linear Amplifiers
- Commercial and Industrial Applications

SNA-200 DC-6.5 GHz Cascadable MMIC Amplifier

Typical Performance at 25° C ($V_{ds} = 4.0V$, $I_{ds} = 50mA$)

50 Ohm Gain Blocks

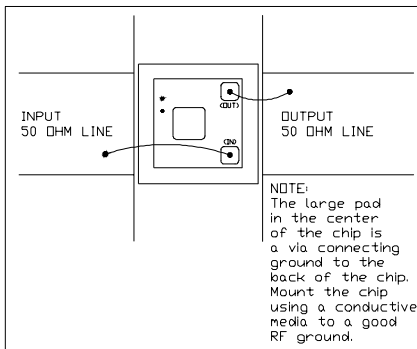
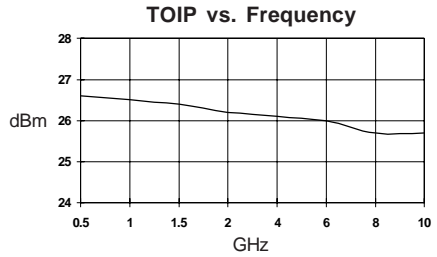
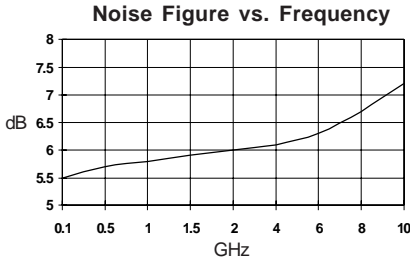
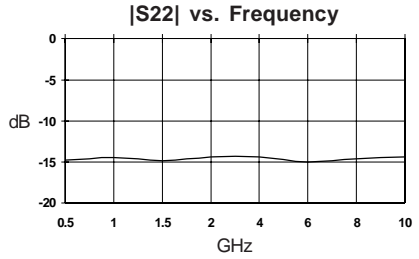
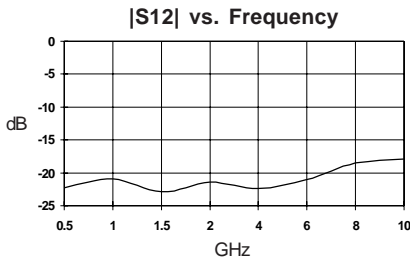
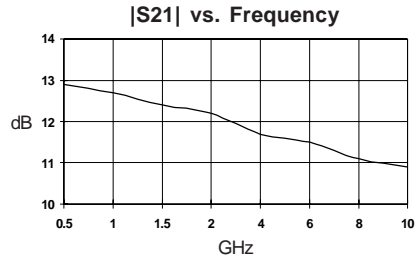
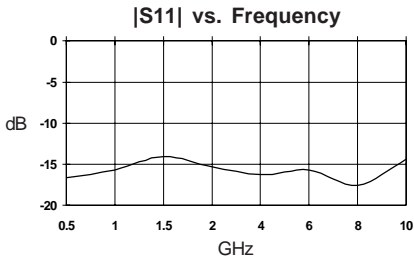

Suggested Bonding Arrangement

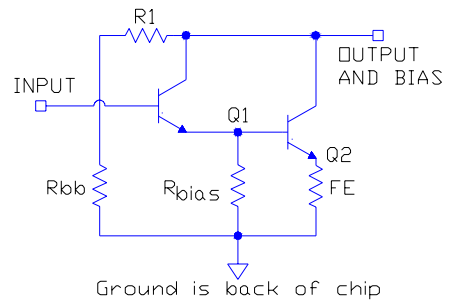

Simplified Schematic of MMIC

Absolute Maximum Ratings

Parameter	Absolute Maximum
Device Current	70mA
Power Dissipation	320mW
RF Input Power	100mW
Junction Temperature	+200C
Operating Temperature	-45C to +85C
Storage Temperature	-65C to +150C

Notes:

1. Operation of this device above any one of these parameters may cause permanent damage.

MTTF vs. Temperature @ $I_d = 50\text{mA}$

Die Bottom Temperature	Junction Temperature	MTTF (hrs)
+55C	+155C	1000000
+90C	+190C	100000
+120C	+220C	10000

Thermal Resistance (Lead-Junction): 500° C/W

Die Attach

The die attach process mechanically attaches the die to the circuit substrate. In addition, it electrically connects the ground to the trace on which the die is mounted and establishes the thermal path by which heat can leave the die.

Assembly Techniques

Epoxy die attach is recommended. The top and bottom metallization is gold. Conductive silver-filled epoxies are recommended. This method involves the use of epoxy to form a joint between the backside gold of the chip and the metallized area of the substrate. A 150 C cure for 1 hour is necessary. Recommended epoxy is Ablebond 84-1LMIT1 from Ablestik.

Part Number Ordering Information

Part Number	Devices Per Pak
SNA-200	100

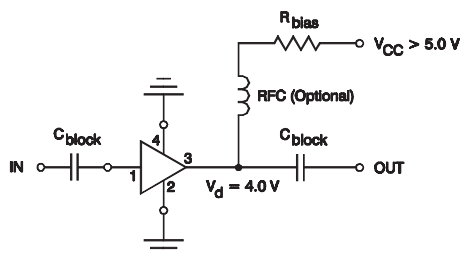

Typical Biasing Configuration

Wire Bonding

Electrical connections to the die are through wire bonds. Stanford Microdevices recommends wedge bonding or ball bonding to the pads of these devices.

Recommended Wedge Bonding Procedure

1. Set the heater block temperature to 260C +/- 10C.
2. Use pre-stressed (annealed) gold wire between 0.0005 to 0.001 inches in diameter.
3. Tip bonding pressure should be between 15 and 20 grams and should not exceed 20 grams. The footprint that the wedge leaves on the gold wire should be between 1.5 and 2.5 wire diameters across for a good bond.