

## FEATURES

- Fully qualified to Class H or K
- -55° to +125°C operation
- 16 to 40 VDC input
- Fully Isolated
- Magnetic feedback
- Fixed frequency, 600 kHz typical
- Topology – Single Ended Forward
- Inhibit input side and output side
- Sync function
- Output trim on single output models
- Indefinite short circuit protection
- Remote sense on single output models
- Up to 87% efficiency
- Parallelable up to 180 watts

# DC/DC CONVERTERS

## 28 VOLT INPUT

# SMFL SERIES

## 65 WATT

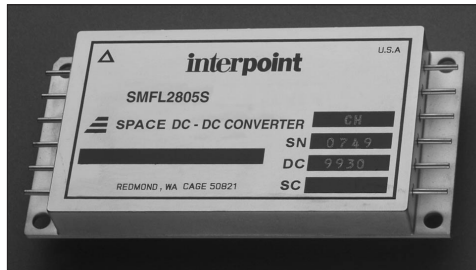

MODELS	
VDC OUTPUT	
SINGLE	DUAL
3.3	±5
5	±12
12	±15
15	

Size (max.): 3.005 x 1.505 x 0.410 inches (76.33 x 38.23 x 10.41 mm)

See Figures 17 and 18 for dimensions. Case options V, W, Y, and Z are available by special order. Please refer to our databook or contact your Interpoint representative for more information.

Weight: 85 grams maximum

Screening: Space prototype, Class H, or Class K (MIL-PRF-38534)

Radiation hardness levels O or R

Available configurations: OO, HO, HR, KR

## DESCRIPTION

The SMFL Series™ 28-volt DC/DC converters are rated up to 65 watts output power over a -55° to +125°C temperature range with a 28 Vdc nominal input. On dual output models up to 70% of the rated output power can be drawn from either the positive or negative outputs. Current sharing allows the units to be paralleled for total power of up to 180 watts. The welded, hermetically sealed package is only 3.0 x 1.5 x 0.40 inches, giving the series an overall power density of up to 45 watts per cubic inch.

## SCREENING AND REPORTS

SMFL converters offer three screening options (Space prototype, Class H, or Class K) and two levels of radiation hardness (O or R). See Tables 1, 2, and 3 for more information. Detailed reports on product performance are also available and are listed in Table 4.

## DESIGN FEATURES

The SMFL Series converters are switching regulators that use a quasi-square wave, single ended forward converter design with a constant switching frequency of 600 kHz typical.

Isolation between input and output circuits is provided with a transformer in the forward path and a wide bandwidth magnetic coupling in the feedback control loop. The SMFL uses a unique dual loop feedback technique that controls output current with an inner feedback loop and an output voltage with a cascaded voltage mode feedback loop.

The additional secondary current mode feedback loop improves transient response in a manner similar to primary current mode control and allows for ease of paralleling, but without the cost and complexity.

The constant frequency, pulse-width modulated converters use a quasi-square wave single-ended forward design. Tight load regulation is achieved through a wide-bandwidth magnetic feedback circuit. The output voltage on single SMFL models can be trimmed to a specific output voltage by adding an external resistor.

## INHIBIT

The SMFL Series converters have two TTL compatible inhibit terminals (INH1 and INH2) that can be used to disable power conversion, resulting in a very low quiescent input current and no generation of switching noise. An open collector TTL compatible low (<0.8 volts) is required to inhibit the converter between INH1 (pin 4) and Input Common (pin 2). An open collector TTL compatible low (<0.5 volts) is required to inhibit the converter between INH2 (pin 12) and Output Common (pin 8). The application of intermediate voltages to these pins (1.5 to 10.5 volts) should be avoided.

## SYNC

Converters may be synced to an external clock (525 to 675 kHz) or to one another by using the sync in or out pins. The nominal free-run switching frequency is 600 kHz.

## CURRENT AND PARALLEL OPERATION

Multiple single output SMFL converters may be used in parallel to drive a common load. In this mode of operation the load current is shared by two or three SMFL converters. In current sharing mode, one SMFL converter is designated as a master. The SLAVE pin (pin 11) of the master is left unconnected and the MSTR/INH2 pin (pin 12) of the master is connected to the SLAVE pin (pin 11) of the slave units. The units designated as slaves have the MSTR/INH2 pin (pin 12) connected to the SNS RTN pin (pin 9). Note that synchronizing the units together is not required for current sharing operation. A second slave unit may be placed in parallel with a master and slave; this requires the TRI pin (pin 3) of the master unit to be connected to the SNS RTN pin (pin 9). See Figure 2 for a block diagram of parallel connections.

When paralleled, 95% of the total combined power ratings of the SMFL converters are available at the load. Overload and short circuit performance are not adversely affected during parallel operation.

# SMFL SERIES

## 65 WATT

# DC/DC CONVERTERS

### ABSOLUTE MAXIMUM RATINGS

- Input Voltage**
- 16 to 40 VDC
- Power Dissipation (Pd)**
- 14 watts (16 watts SMFL2805S, SMFL2805D)
- Output Power**
- 40 to 65 watts depending on model
- Lead Soldering Temperature (10 sec per lead)**
- 300°C
- Storage Temperature Range (Case)**
- -65°C to +150°C

### RECOMMENDED OPERATING CONDITIONS

- Input Voltage Range**
- 16 to 40 VDC continuous
- Case Operating Temperature (Tc)**
- -55°C to +125°C full power

### SYNC AND INHIBIT (INH1, INH2)

- Sync In (525 to 675 kHz)**
- Duty cycle 40% min, 60% max
  - Logic low 0.8 V max
  - Logic high 4.5 V min, 9 V max
  - Referenced to input common
  - If not used, connect to input common
- Sync Out**
- Referenced to input common
  - If not used, leave unconnected
- Inhibit (INH1, INH2) TTL Open Collector**
- Logic low (output disabled)
  - INH1 referenced to input common
    - Logic low 0.8 V max
    - Inhibit pin current 10 mA max
  - INH2 referenced to output common
    - Logic low 0.5 V max
    - Inhibit pin current 5 mA max
  - Logic high (output enabled)
  - Open collector
  - If not used, leave unconnected

### TYPICAL CHARACTERISTICS

- Output Voltage Temperature Coefficient**
- 100 ppm/°C typical
- Input to Output Capacitance**
- 150 pF, typical
- Isolation**
- 100 megohm minimum at 500 V
- Audio Rejection**
- 50 dB typical
- Conversion Frequency**
- Free run mode 600 kHz typical
  - 550 kHz, min, 650 kHz max
  - External sync range 525 to 675 kHz
- Inhibit Pin Voltage (unit enabled)**
- INH1 = 9 to 12 V, INH2 = 6 to 9 V

### PINS NOT USED

- TR1, Master, and Slave**
- If not used, leave unconnected

**Electrical Characteristics: 25°C Tc, 28 VDC Vin, 100% load, radiation level O, unless otherwise specified.**

SINGLE OUTPUT MODELS		SMFL283R3S			SMFL2805S			SMFL2812S			SMFL2815S			UNITS
PARAMETER	CONDITION	MIN	TYP	MAX	MIN	TYP	MAX	MIN	TYP	MAX	MIN	TYP	MAX	
OUTPUT VOLTAGE	Tc = 25°C	3.27	3.3	3.33	4.95	5.00	5.05	11.88	12.00	12.12	14.85	15.00	15.15	VDC
OUTPUT CURRENT	VIN = 16 TO 40 VDC	0	—	12	0	—	10	0	—	5	0	—	4.33	A
OUTPUT POWER	VIN = 16 TO 40 VDC	0	—	40	0	—	50	0	—	60	0	—	65	W
OUTPUT RIPPLE	Tc = 25°C	—	10	35	—	15	35	—	30	75	—	30	85	mV p-p
VOLTAGE 10 k - 2 MHz	Tc = -55°C to +125°C	—	10	50	—	30	50	—	45	100	—	45	110	
LINE REGULATION	VIN = 16 to 40 VDC	—	0	20	—	0	20	—	0	20	—	0	20	mV
LOAD REGULATION	NO LOAD TO FULL	—	—	20	—	—	20	—	—	20	—	—	20	mV
INPUT VOLTAGE	CONTINUOUS	16	28	40	16	28	40	16	28	40	16	28	40	VDC
	TRANSIENT <sup>1, 4</sup> 50 ms	—	—	50	—	—	50	—	—	50	—	—	50	V
INPUT CURRENT	NO LOAD	—	70	100	—	70	120	—	50	80	—	50	80	mA
	FULL LOAD	—	—	2.1	—	—	2.5	—	—	2.8	—	—	3.0	A
	INHIBITED - INH1	—	9	14	—	9	14	—	9	14	—	9	14	mA
	INHIBITED - INH2	—	35	70	—	35	70	—	35	70	—	35	70	
INPUT RIPPLE CURRENT	10 kHz - 10 MHz	—	15	50	—	15	50	—	15	50	—	15	50	mA pp
EFFICIENCY	Tc = 25°C	70	—	—	75	80	—	81	86	—	82	87	—	%
LOAD FAULT <sup>2</sup>	POWER DISSIPATION													
	SHORT CIRCUIT													
	Tc = 25°C	—	12.5	14	—	12.5	16	—	10	14	—	10	14	W
	RECOVERY	—	1.5	4	—	1.5	4	—	1.5	4	—	1.5	4	ms
STEP LOAD RESP.	50% - 100% - 50%													
	TRANSIENT	—	200	300	—	250	350	—	450	700	—	500	700	mV p
	RECOVERY <sup>3, 4</sup>	—	1.5	3.0	—	1.5	3.0	—	1.5	3.0	—	1.5	3.0	ms
STEP LINE RESP <sup>3, 4</sup>	16 - 40 - 16 VDC													
	TRANSIENT	—	250	300	—	250	300	—	250	400	—	250	400	mV pk
	RECOVERY	—	200	30	—	200	300	—	200	300	—	200	300	µs
START-UP	DELAY	—	3.5	6	—	3.5	6	—	3.5	6	—	3.5	6	ms
	OVERSHOOT <sup>4</sup>	—	0	25	—	0	25	—	0	50	—	0	50	mV pk

#### Notes

- Unit will shut down above approximately 45V but will be undamaged and will restart when voltage drops into normal range.
- Indefinite short circuit protection not guaranteed above 125°C case.
- Recovery time is measured from application of the transient to point at which Vout is within 1% of final value.
- Guaranteed but not tested.

# DC/DC CONVERTERS

# SMFL SERIES 65 WATT

Electrical Characteristics: 25°C Tc, 28 VDC Vin, 100% load, radiation level O, unless otherwise specified.

DUAL OUTPUT MODELS		SMFL2805D			SMFL2812D			SMFL2815D			UNITS
PARAMETER	CONDITIONS	MIN	TYP	MAX	MIN	TYP	MAX	MIN	TYP	MAX	
OUTPUT VOLTAGE	Tc = 25°C +V <sub>OUT</sub> -V <sub>OUT</sub>	4.95	5.00	5.05	11.88	12.00	12.12	14.85	15.00	15.15	VDC
		4.92	5.00	5.08	11.82	12.00	12.18	14.77	15.00	15.23	
OUTPUT CURRENT <sup>1</sup>	V <sub>IN</sub> = 16 TO 40 VDC EACH OUTPUT TOTAL OUTPUT	0	—	7	0	—	3.5	0	—	3.03	A
		0	—	10	0	—	5	0	—	4.33	
		0	—	50	0	—	60	0	—	65	
OUTPUT POWER	V <sub>IN</sub> = 16 TO 40 VDC	0	—	50	0	—	60	0	—	65	W
OUTPUT RIPPLE VOLTAGE ± V <sub>OUT</sub>	10 kHz - 2 MHz	—	50	100	—	50	120	—	50	150	mV p-p
LINE REGULATION	V <sub>IN</sub> = 16 TO 40 VDC +V <sub>OUT</sub> -V <sub>OUT</sub>	—	0	50	—	0	50	—	0	50	mV
		—	25	100	—	25	100	—	25	100	
		—	0	50	—	10	100	—	10	100	
LOAD REGULATION	NO LOAD TO FULL +V <sub>OUT</sub> -V <sub>OUT</sub>	25	100	—	50	120	—	50	150	—	mV
		—	0	50	—	10	100	—	10	100	
CROSS REGULATION	SEE NOTE 2	—	5	8	—	2	4	—	2	4	%
	SEE NOTE 3	—	3	6	—	2	4	—	2	4	
INPUT VOLTAGE	CONTINUOUS	16	28	40	16	28	40	16	28	40	VDC
	TRANSIENT <sup>4, 7</sup> 50 ms.	—	—	50	—	—	50	—	—	50	
INPUT CURRENT	NO LOAD	—	50	120	—	50	100	—	50	100	mA
	FULL LOAD	—	—	2.40	—	—	2.80	—	—	3.00	A
	INHIBITED - INH1	—	9	14	—	9	14	—	9	14	mA
	INHIBITED - INH2	—	35	70	—	35	70	—	35	70	
INPUT RIPPLE CURRENT	10 kHz - 10 MHz	—	15	50	—	15	50	—	15	50	mA p-p
EFFICIENCY	BALANCED LOAD	75	80	—	81	86	—	82	87	—	%
LOAD FAULT <sup>5</sup>	POWER DISSIPATION	—	—	—	—	—	—	—	—	—	W
	SHORT CIRCUIT	—	12.5	16	—	10	14	—	10	14	
	RECOVERY	—	1.5	4.0	—	1.5	4.0	—	1.5	4.0	
STEP LOAD RESPONSE ± V <sub>OUT</sub>	50%–100%–50% LOAD TRANSIENT RECOVERY <sup>6, 7</sup>	—	250	350	—	450	600	—	500	600	mV pk
		—	1.5	3.0	—	1.5	3.0	—	1.5	3.0	
		—	250	300	—	250	400	—	250	400	
STEP LINE <sup>6, 7</sup> RESPONSE ± V <sub>OUT</sub>	16 – 40 – 16 V <sub>IN</sub> TRANSIENT <sup>7</sup>	—	250	300	—	250	400	—	250	400	mV pk
	RECOVERY	—	200	300	—	200	300	—	200	300	µs
START-UP	DELAY	—	3.5	6	—	3.5	6	—	3.5	6	ms
	OVERSHOOT <sup>7</sup>	—	0	25	—	0	50	—	0	50	mV pk

## Notes

- Up to 70% of the total output power is available from either output providing the opposite output is simultaneously carrying 30% of the total power.
- Effect on the negative output under the following conditions:  
+P<sub>out</sub> 30% to 70%; -P<sub>out</sub> 70% to 30%
- Effect on the negative output under the following conditions:  
+P<sub>out</sub> 50%; -P<sub>out</sub> 10% to 50%
- Unit will shut down above approximately 45V but will be undamaged and will restart when voltage drops into normal range.
- Indefinite short circuit protection not guaranteed above 125°C case.
- Recovery time is measured from application of the transient to point at which V<sub>out</sub> is within 1% of final value.
- Guaranteed but not tested.

## SINGLE OUTPUT MODELS CONNECTION DIAGRAMS - SENSE AND PARALLEL

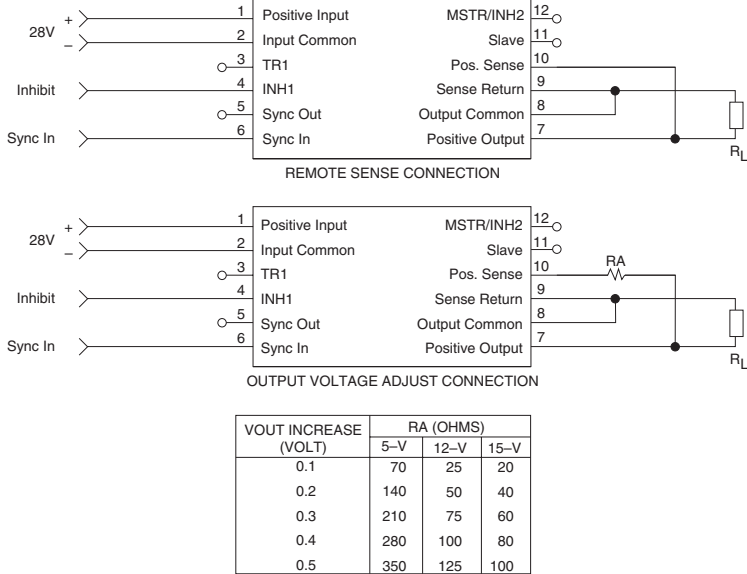

FIGURE 1: SENSE CONNECTIONS AND TRIM TABLE

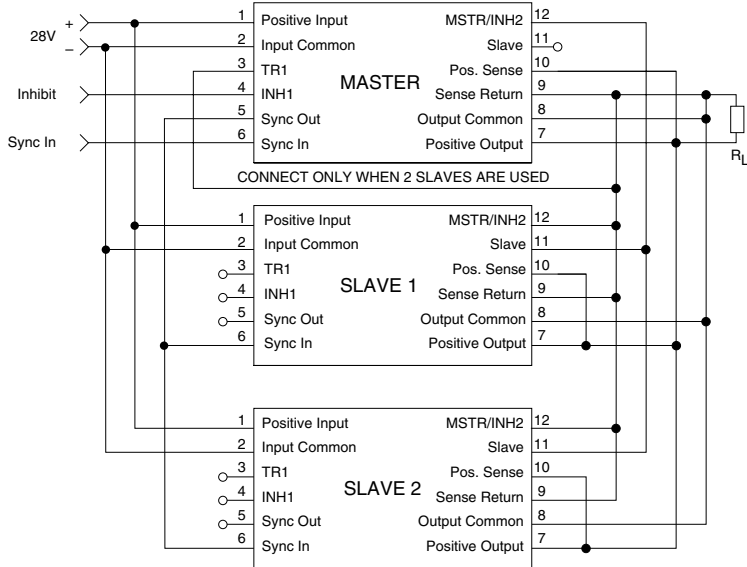
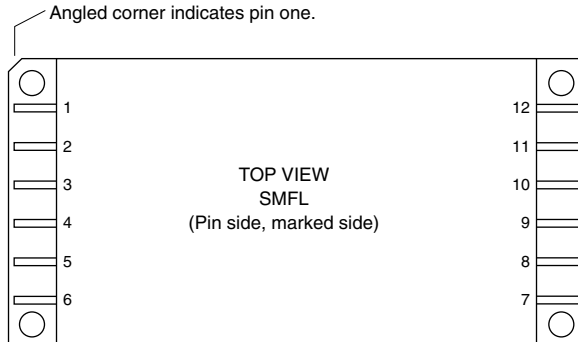

FIGURE 2: PARALLEL CONNECTIONS

## PIN OUT

Pin	Single Output	Dual Output
1	Positive Input	Positive Input
2	Input Common	Input Common
3	Triple (TRI)	Triple (TRI)
4	Inhibit 1 (INH1)	Inhibit 1 (INH1)
5	Sync Out	Sync Out
6	Sync In	Sync In
7	Positive Output	Positive Output
8	Output Common	Output Common
9	Sense Return	Negative Output
10	Positive Sense	No connection
11	Slave	Slave
12	Master / Inhibit 2	Master / Inhibit 2



See Figures 17 and 18 for dimensions.

**FIGURE 3: PIN OUT**

Pin 6 should be connected to input common if external sync (Sync In) is not used.  
Sense pins must be connected to their respective outputs if not used.

## MODEL NUMBERING KEY

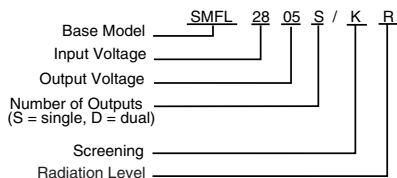

## SMD NUMBERS

### STANDARD MICROCIRCUIT DRAWING (SMD)

IN PROCESS  
5962-9316302HXC  
IN PROCESS  
IN PROCESS  
IN PROCESS  
IN PROCESS  
5962-9319302HXC

### SMFL SERIES SIMILAR PART

SMFL283R3S/HO  
SMFL2805S/HO  
SMFL2812S/HO  
SMFL2815S/HO  
SMFL2805D/HO  
SMFL2812D/HO  
SMFL2815D/HO

The SMD number shown is for Class H screening, non-flanged, and no Radiation Hardness Assurance (RHA) level. See the SMD for the numbers for other screening and radiation levels. For exact specifications for an SMD product, refer to the SMD drawing. Call your Interpoint representative for status on the SMFL SMD releases which are "in process."  
SMDs can be downloaded from  
<http://www.dscclia.mil/programs/smcr>

**Typical Performance Curves: 25°C Tc, 28 VDC Vin, 100% load, free run, unless otherwise specified.**

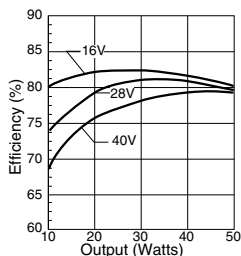

SMFL2805S & SMFL2805D Efficiency

**FIGURE 4**

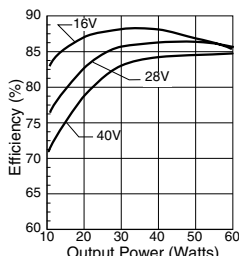

SMFL2812S & SMFL2812D Efficiency

**FIGURE 5**

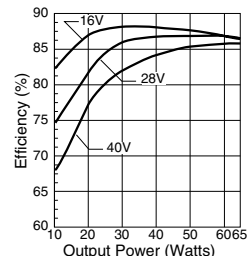

SMFL2815S & SMFL2815D Efficiency

**FIGURE 6**

Typical Performance Curves: 25°C Tc , 28 VDC Vin, 100% load, free run, unless otherwise specified.

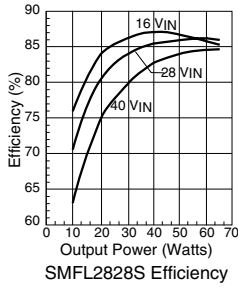

**FIGURE 7**

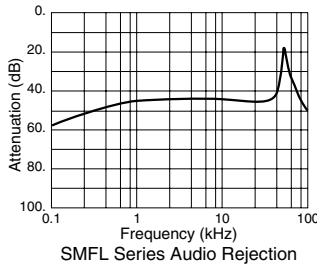

**FIGURE 8**

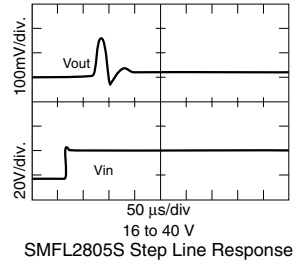

**FIGURE 9**

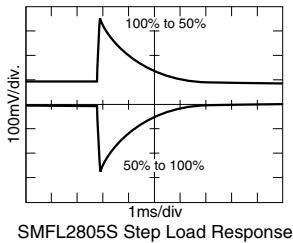

**FIGURE 10**

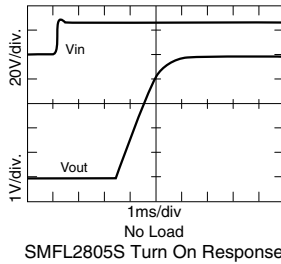

**FIGURE 11**

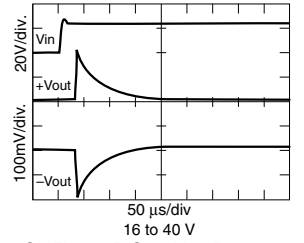

**FIGURE 12**

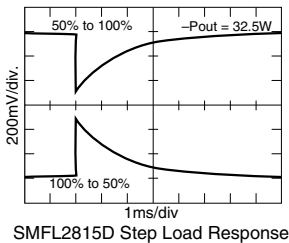

**FIGURE 13**

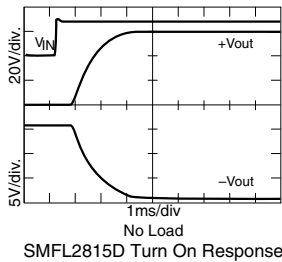

**FIGURE 14**

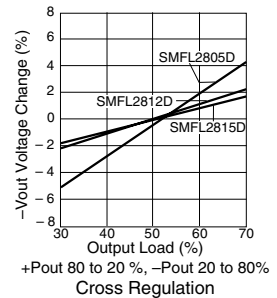

**FIGURE 15**

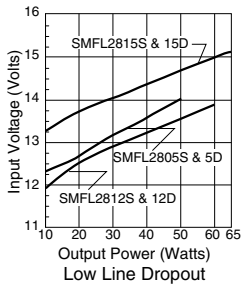

**FIGURE 16**

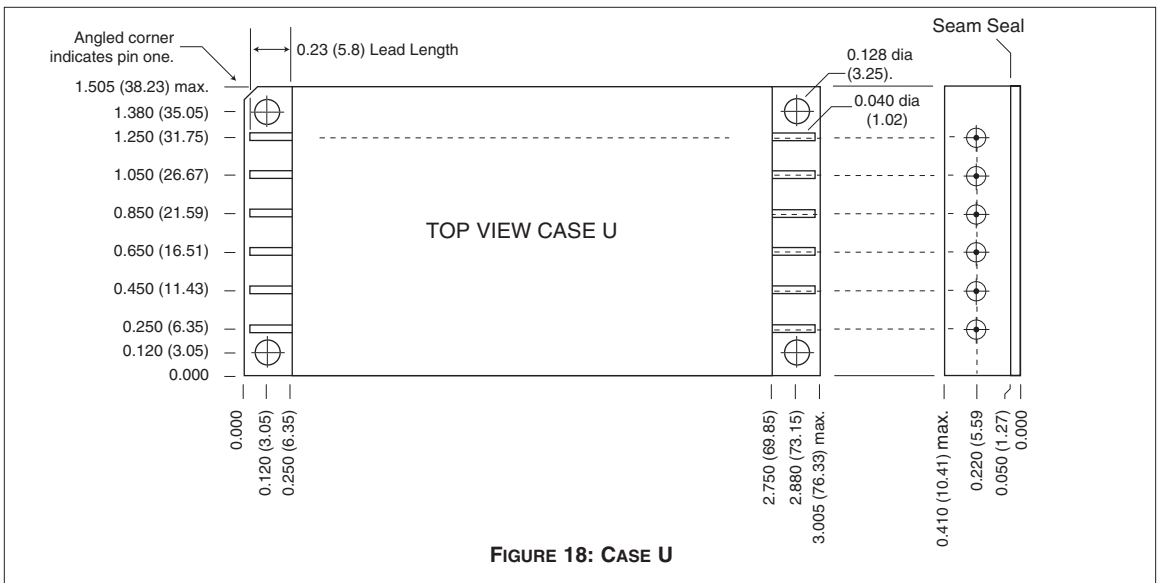
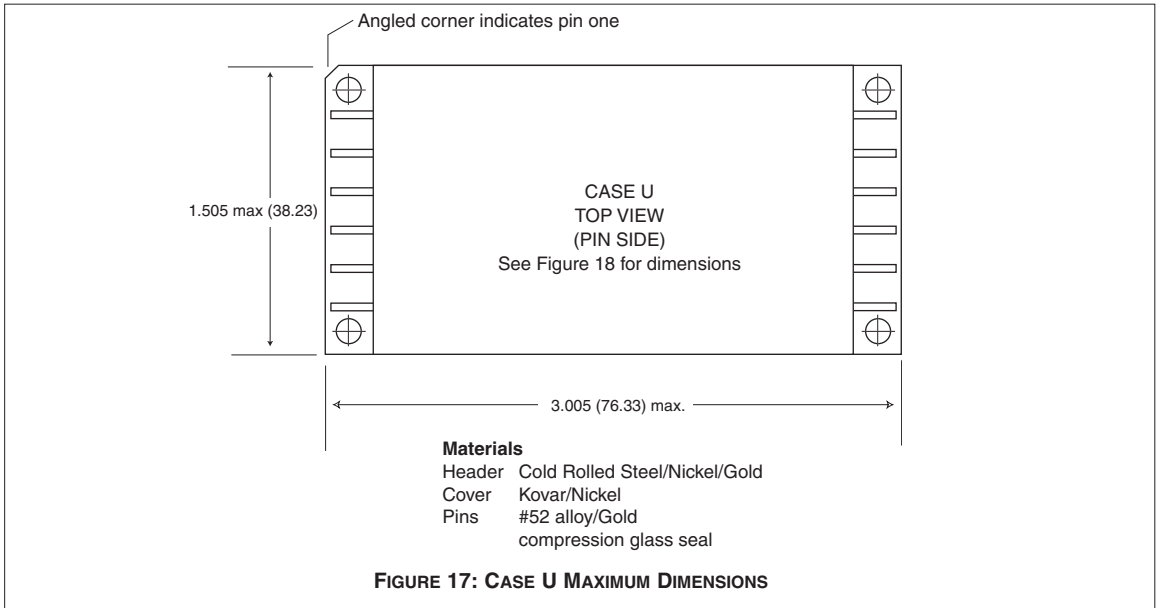

**CAUTION**

Heat from reflow or wave soldering may damage the device. Solder pins individually with heat application not exceeding 300°C for 10 seconds per pin.

**Case dimensions in inches (mm)**

Tolerance  $\pm 0.005$  (0.13) for three decimal places,  $\pm 0.01$  (0.2) for two decimal places unless otherwise specified

Although every effort has been made to render the case drawings at actual size, variations in the printing process may cause some distortion. Please refer to the numerical dimensions for accuracy.

**TABLE 1: ELEMENT EVALUATION**

ELEMENT EVALUATION  TEST PERFORMED (COMPONENT LEVEL)	SPACE		CLASS		CLASS	
	PROTOTYPE		H		K	
	(O)		M/S	P	M/S	P
Element Electrical	yes	no	yes	yes	yes	yes
Element Visual	no	no	yes	yes	yes	yes
Internal Visual	no	no	yes	no	yes	no
Temperature Cycling	no	no	no	no	yes	yes
Constant Acceleration	no	no	no	no	yes	yes
Interim Electrical	no	no	no	no	yes	no
Burn-in	no	no	no	no	yes	no
Post Burn-in Electrical	no	no	no	no	yes	no
Steady State Life	no	no	no	no	yes	no
Voltage Conditioning /Aging	no	no	no	no	no	yes
Visual Inspection	no	no	no	no	no	yes
Final Electrical	no	no	yes	yes	yes	yes
Wire Bond Evaluation	no	no	yes	yes	yes	yes
SEM	no	no	no	no	yes	no
SLAM™/C-SAM: Input capacitors only (Add'l test, not req. by H or K)	no	no	no	yes	no	yes

**Notes**

M/S Active components (Microcircuit and Semiconductor Die)

P Passive components

**Definitions**

Element Evaluation: Component testing/screening per MIL-STD-883 as determined by MIL-PRF-38534

SEM: Scanning Electron Microscopy

SLAM™: Scanning Laser Acoustic Microscopy

C-SAM: C - Mode Scanning Acoustic Microscopy



**TABLE 2: PRODUCT ENVIRONMENTAL SCREENING**

<b>ENVIRONMENTAL SCREENING TEST PERFORMED (END ITEM LEVEL)</b>	<b>SPACE PROTOTYPE (O)</b>	<b>CLASS H</b>	<b>CLASS K</b>
Non-destruct bond pull Method 2023	no	yes	yes
Pre-cap inspection Method 2017, 2032	yes	yes	yes
Temperature cycle Method 1010, Cond. C	yes	yes	yes
Constant acceleration Method 2001, 3000 g	yes	yes	yes
PIND Test Method 2020, Cond. B	no	yes	yes
Radiography Method 2012	no	no	yes
Pre burn-in test	yes	yes	yes
Burn-in, Method 1015, 125°C			
96 hours	yes	no	no
160 hours	no	yes	no
2 x 160 hour (includes mid BI test)	no	no	yes
Final electrical test MIL-PRF-38534, Group A	yes	yes	yes
Hermeticity test			
Fine Leak, Method 1014, Cond. A	yes	yes	yes
Gross Leak, Method 1014, Cond. C	yes	yes	yes
Final visual inspection Method 2009	yes	yes	yes

Test methods are referenced to MIL-STD-883 as determined by MIL-PRF-38534.

**TABLE 3: RADIATION HARDNESS LEVELS**

PRODUCT LEVEL AVAILABILITY	ENVIRONMENTAL SCREENING LEVELS		
	SPACE PROTOTYPE (O)	CLASS H	CLASS K
<b>RADIATION HARDNESS LEVELS</b>			
<b>O:</b> Standard, no radiation guarantee For system evaluation, electrically and mechanically comparable to H and K level.	OO	HO	Not available
<b>R:</b> Radiation hardened – Tested lots Up to 100 k Rads (Si) total dose SEU guarantee up to 40 MeV	Not available	HR	KR

R is referenced to MIL-PRF-38534, appendix G, Radiation Hardness Assurance (RHA) levels.

**Contact Information:**

[www.interpoint.com](http://www.interpoint.com)

Interpoint Headquarters USA  
Phone: 1-800-822-8782  
+425-882-3100  
Email: [power@intp.com](mailto:power@intp.com)

Interpoint UK  
Phone: +44-1252-872266  
Email: [poweruk@intp.com](mailto:poweruk@intp.com)

Interpoint France  
Phone: +33-134285455  
Email: [powerfr@intp.com](mailto:powerfr@intp.com)