

COMPACT HIGH POWER RELAY

1 POLE—30 A

(FOR AUTOMOTIVE APPLICATIONS)

FBR56 SERIES

■ FEATURES

- High power contact capacity
(carrying current: 40 A/2 minutes, 30 A/1 hour)
- High heat resistance and extended operating voltage



■ ORDERING INFORMATION

[Example] FBR56 N D12 - W1 **
 (a) (b) (c) (d) (e)

(a)	Series Name	FBR56 : FBR56 Series relay for 12 V battery (contact gap 0.4 mm)
(b)	Enclosure	N : Plastic sealed type
(c)	Nominal Voltage	D06 : 6 VDC D09 : 9 VDC D12 : 12 VDC
(d)	Contact Material	W1 : Silver-tin oxide indium
(e)	Custom Designation	To be assigned custom specification

FBR56 SERIES

■ SPECIFICATIONS

Item		Specifications	
Contact	Arrangement	1 form C	
	Material	Silver-tin oxide indium (-W1 type)	
	Voltage Drop (resistance)	Maximum 100 mV (at 1 A 6 VDC)	
	Ratings	14 VDC 20 A (locked motor load) 14 VDC inrush 20 A, break 4 A (motor free load)	
	Maximum Carrying Current	40 A/2 minutes, 30 A/1 hour (25°C, 100% rated coil voltage)	
	Maximum Inrush Current	-W1 type: 60 A (reference)	
	Maximum Switching Current	40 A 16 VDC (reference)	
	Minimum Switching Load*1	-W1 type: 6 VDC, 1 A	
Coil	Operating Temperature	-40°C to +85°C (no frost) (refer to the CHARACTERISTIC DATA)	
	Storage Temperature	-40°C to +100°C (no frost)	
Time Value	Operate (at nominal voltage)	Maximum 10 ms	
	Release (at nominal voltage)	Maximum 5 ms	
Life	Mechanical	10 × 10 ⁶ operations minimum	
	Electrical	100 × 10 ³ operations minimum (locked motor load) 1 × 10 ⁶ operations minimum (motor free load)	
Other	Vibration Resistance	10 to 55 Hz (double amplitude of 1.5 mm)	
	Shock Resistance	Misoperation	100 m/s ²
		Endurance	1,000 m/s ²
	Weight	Approximately 9.4 g	

*1 Values when switching a resistive load at normal room temperature and humidity, and in a clean environment.
The minimum switching load varies with the switching frequency and operating environment.

■ COIL DATA CHART

MODEL	Nominal voltage	Coil resistance (±10%) (at 20°C)	Must operate voltage	Release voltage
W1 contact				
FBR56ND06-W1	6 VDC	42 Ω	3.6 VDC (at 20°C) 4.5 VDC (at 85°C)	0.5VDC(at 20°C) 0.6 VDC (at 85°C)
FBR56ND09-W1	9 VDC	95 Ω	5.4 VDC (at 20°C) 6.8 VDC (at 85°C)	0.7 VDC (at 20°C) 0.8 VDC (at 85°C)
FBR56ND12-W1	12 VDC	170 Ω	7.3 VDC (at 20°C) 9.2 VDC (at 85°C)	1.0 VDC (at 20°C) 1.2 VDC (at 85°C)

FBR56 SERIES

■ PRINCIPAL APPLICATIONS

Application		Normal load current	Life x 10 ³	Recommended model (Example)
For 12 V battery	Power Windows	20 to 30 A (switching at motor locking)	100	FBR56N□-W1
	Automatic Door Lock	18 to 30 A/4 to 5 door (switching at motor locking)	100	FBR56N□-W1
	Intermittent Wipers	INRUSH 15 to 30 A BREAK 2 to 8 A (motor free)	300	FBR56N□-W1
	Tilt-Lock Wheel	INRUSH 15 A BREAK 2.5 A (motor free)	100	FBR56N□-W1
	Sunroof	20 to 30 A (switching at motor locking)	100	FBR56N□-W1
	Others	Car audio system, etc.	—	FBR56N□-W1

■ CHARACTERISTIC DATA

1. MAXIMUM BREAK CAPACITY

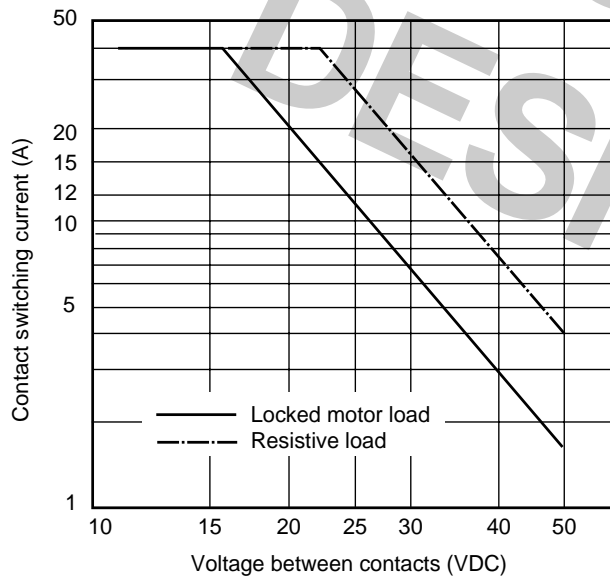

2. LIFE

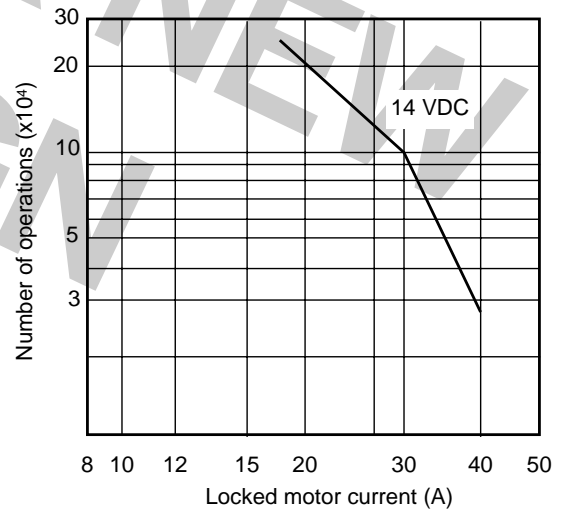

3. LIFE TEST (EXAMPLE)

- Test item
14 V DC-20 A
Motor lock
200,000 operations minimum
(FBR56 □-W1 type)

- Test circuit

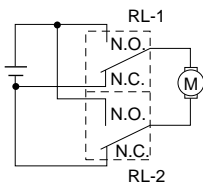

- Shift of pick-up and drop-out voltage

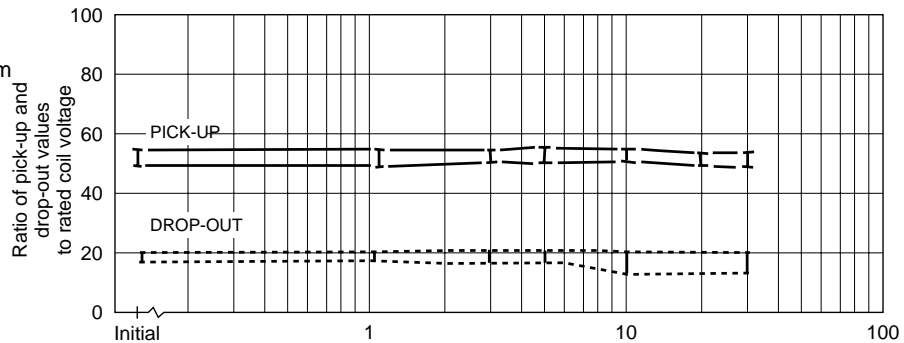

- Current wave form

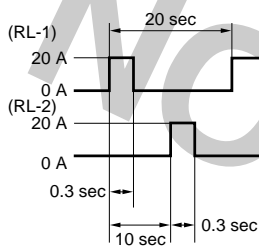

- Shift of contact resistance

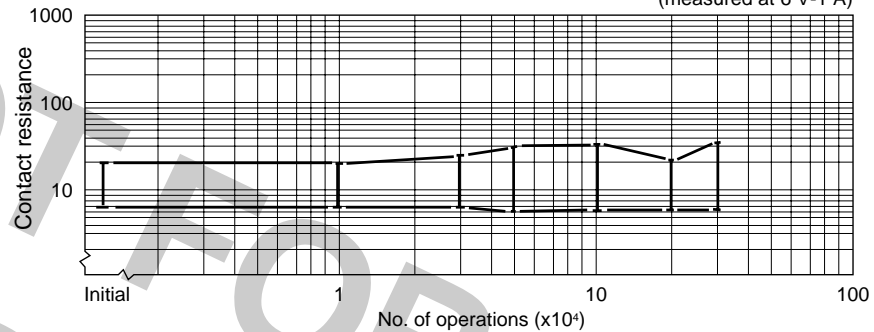

- Test item
14 V DC-30 A
Motor lock
100,000 operations minimum
(FBR56 □-W1 type)

- Test circuit

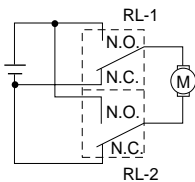

- Shift of pick-up and drop-out voltage

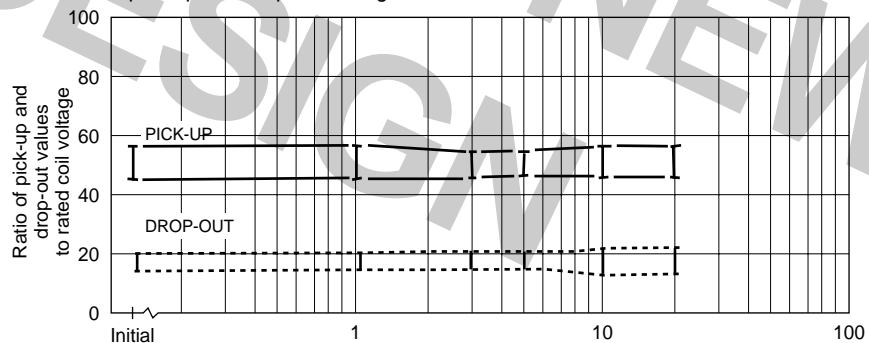

- Current wave form

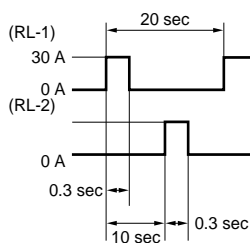

- Shift of contact resistance

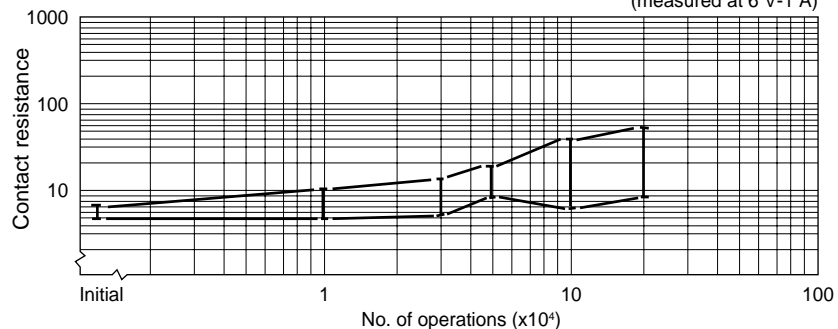

(Continued)

(Continued)

- Test item
16 V DC-25 A INRUSH
Motor free
400,000 operations minimum
(FBR56 □-W1 type)

- Test circuit

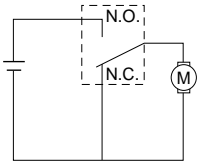

- Shift of pick-up and drop-out voltage

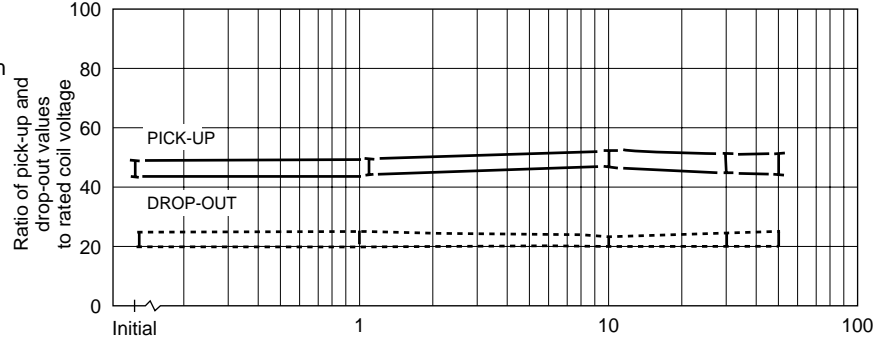

- Current wave form

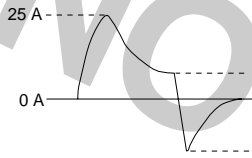

- Shift of contact resistance

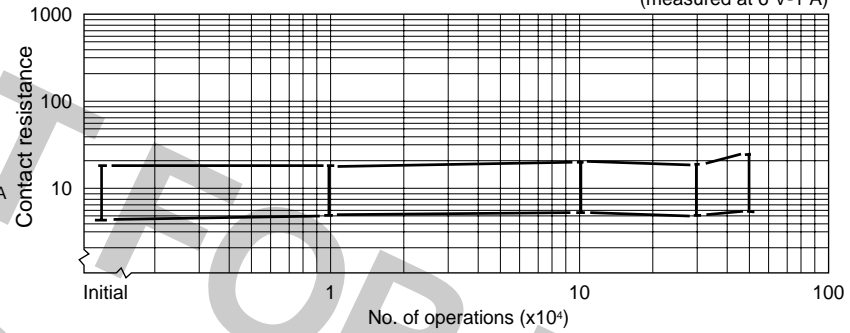

4. COIL TEMPERATURE RISE

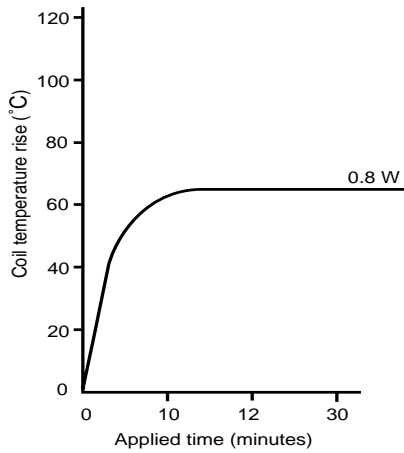

5. OPERATING COIL VOLTAGE RANGE (EXAMPLE)

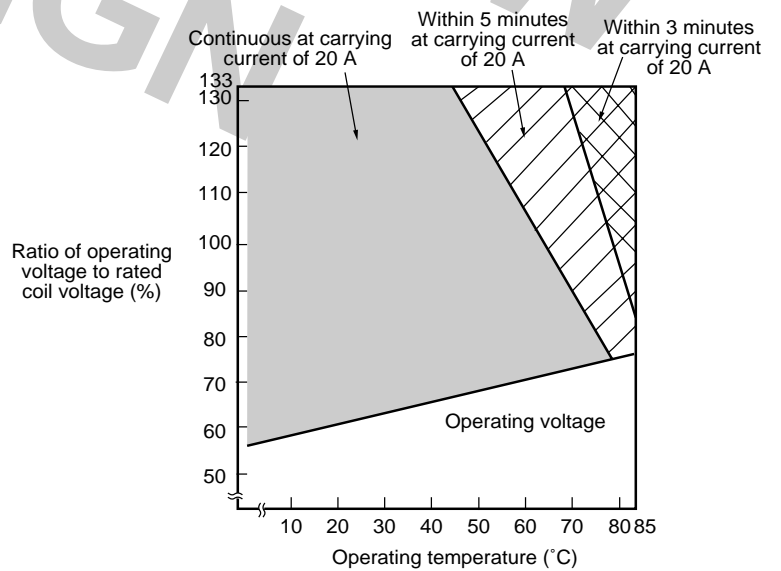

FBR56 SERIES

6. VIBRATION RESISTANCE CHARACTERISTICS

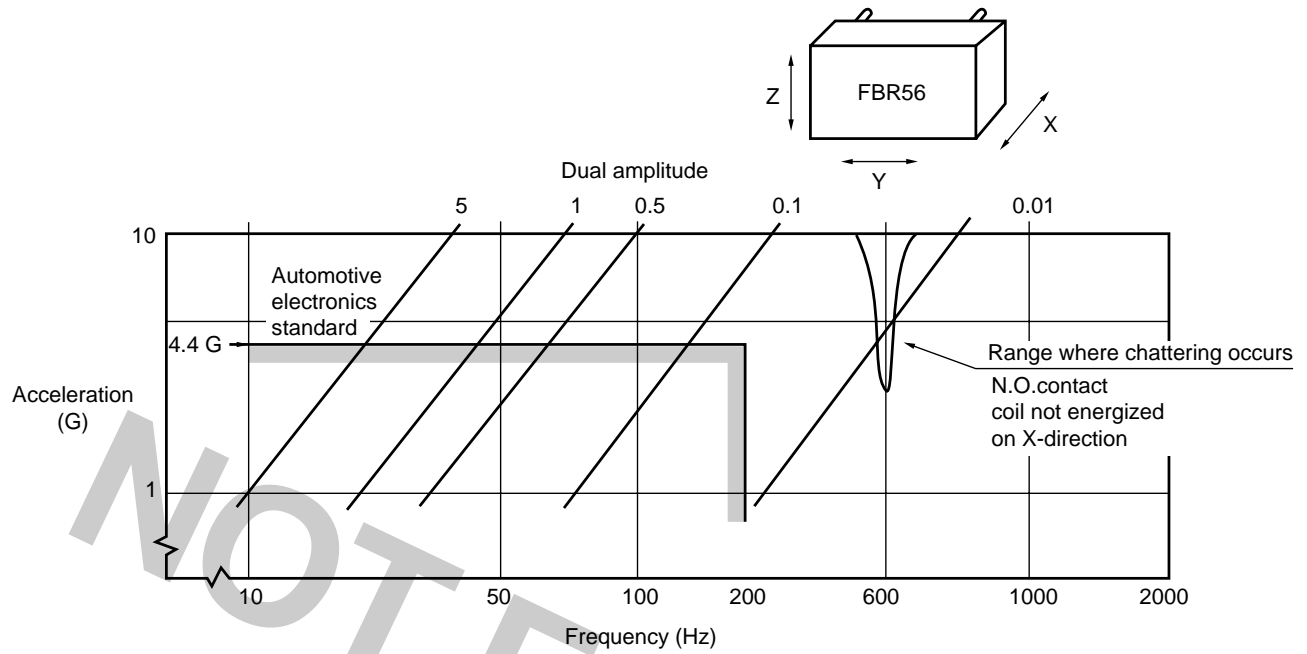

7. SHOCK RESISTANCE CHARACTERISTICS

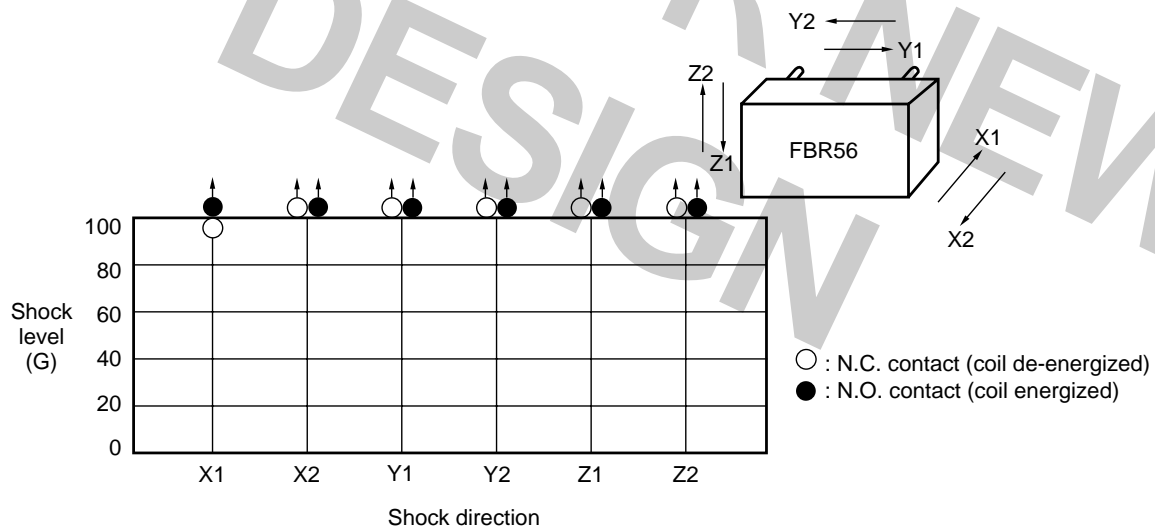

FBR56 SERIES

REFERENCE DATA

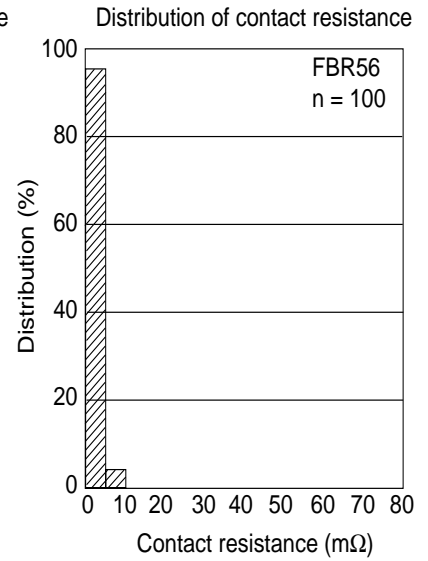
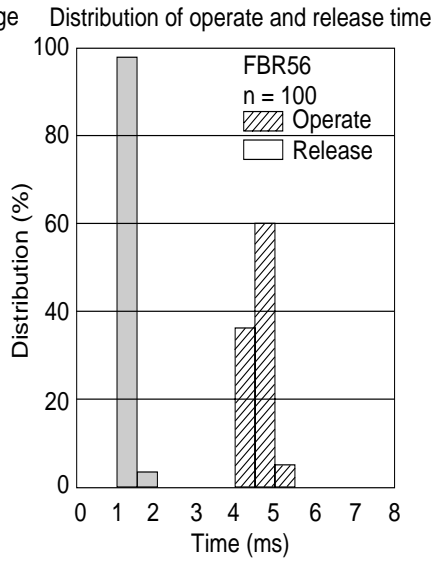
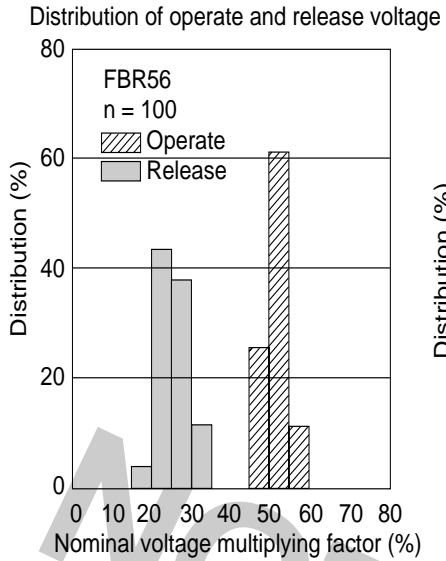

DIMENSIONS

Dimensions

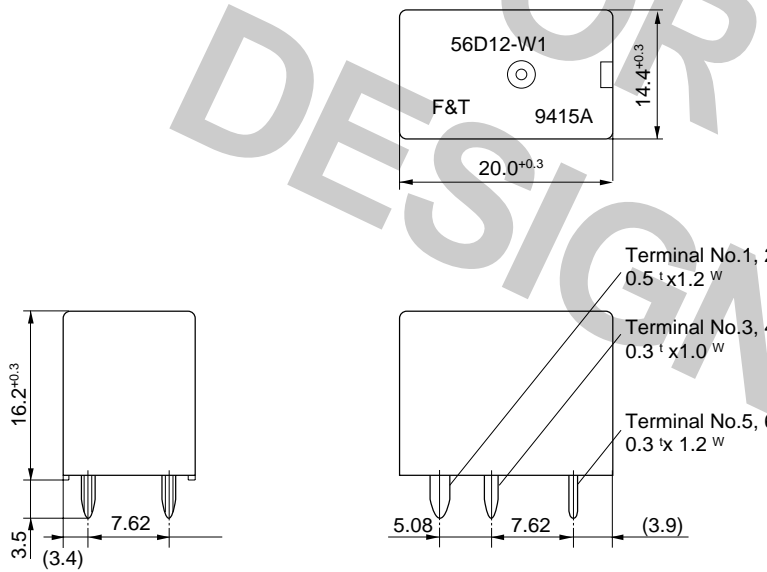

PC board mounting hole layout (BOTTOM VIEW)

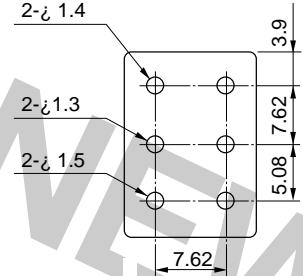

Schematics (BOTTOM VIEW)

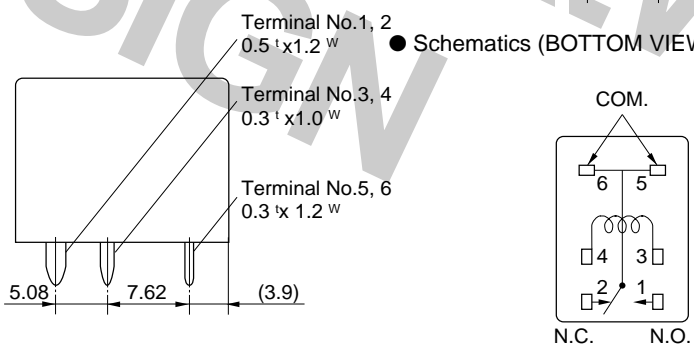

Tube carrier

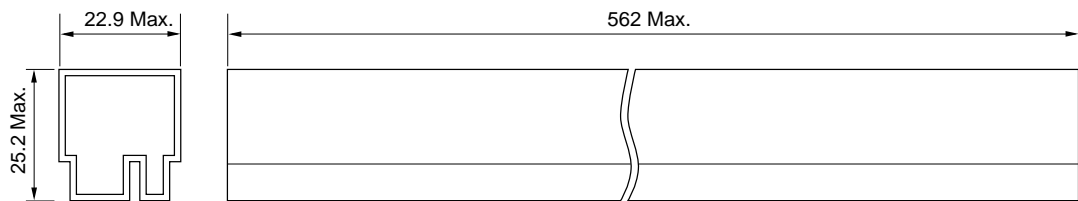

35 pcs/tube

Unit : mm

Fujitsu Components International Headquarter Offices

Japan

Fujitsu Component Limited
Gotanda-Chuo Building
3-5, Higashigotanda 2-chome, Shinagawa-ku
Tokyo 141, Japan
Tel: (81-3) 5449-7010
Fax: (81-3) 5449-2626
Email: promothq@fcl.fujitsu.com
Web: www.fcl.fujitsu.com

North and South America

Fujitsu Components America, Inc.
250 E. Caribbean Drive
Sunnyvale, CA 94089 U.S.A.
Tel: (1-408) 745-4900
Fax: (1-408) 745-4970
Email: marcom@fcai.fujitsu.com
Web: www.fujitsu.com/us/services/edevices/components/

Europe

Fujitsu Components Europe B.V.
Diamantlaan 25
2132 WV Hoofddorp
Netherlands
Tel: (31-23) 5560910
Fax: (31-23) 5560950
Email: info@fceu.fujitsu.com
Web: www.fujitsu.com/emea/services/components/

Asia Pacific

Fujitsu Components Asia Ltd.
102E Pasir Panjang Road
#04-01 Citilink Warehouse Complex
Singapore 118529
Tel: (65) 6375-8560
Fax: (65) 6273-3021
Email: fcal@fcal.fujitsu.com
Web: www.fujitsu.com/sg/services/micro/components/

© 2005 Fujitsu Components America, Inc. All rights reserved. All company and product names are trademarks or registered trademarks of their respective owners.

Fujitsu Components America, Inc. does not warrant that the content of the datasheet is error free. In a continuing effort to improve our products Fujitsu Components America, Inc. reserves the right to make changes to the specifications, datasheets or products at any time without prior notice.

Rev. 11/07/2005.

NOT FOR NEW
DESIGN