

5N Type Light Touch Switches

Japan
Malaysia
China

Type: **EVQPA/EVQPB/EVQPF**
EVQ2/EVQPC

Broad product range meets a variety of needs

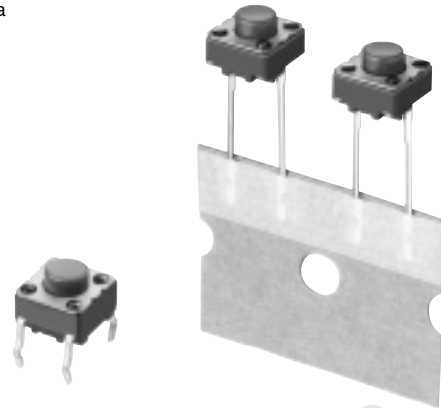

■ Features

- 6.0 mm×6.0 mm square, body thickness 3.2 mm
- Travel 0.25 mm (clear click feeling)
- Wide selection with or without ground terminal, top-push or side-operation type with snap-in terminals available
- Wave soldering applicable

■ Recommended Applications

- Operation button switches for audio/visual, OA, communication equipment, measurement instruments

■ Explanation of Part Numbers

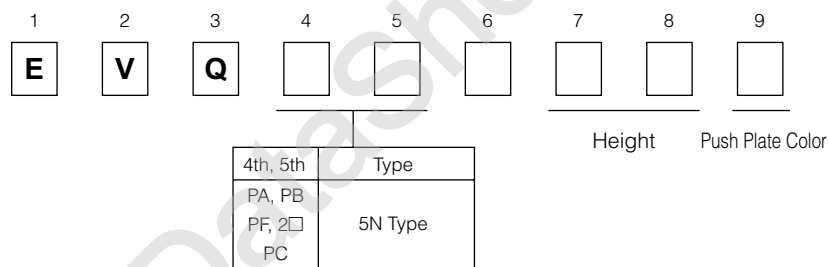

■ Product Chart

○=In production

Operating Force	Positioning Pin	Ground Terminal	Top-push Type				Side-operation Type			
			4.3 mm	5.0 mm	7.0 mm	9.5 mm	3.15 mm	3.85 mm	5.85 mm	8.35 mm
1.0 N	Without positioning pin	With ground terminal	○	○	○	○	○	○	○	○
		Without ground terminal	○	○	○	○	—	—	—	—
1.3 N	Without positioning pin	With ground terminal	○	○	○	○	○	○	○	○
		Without ground terminal	○	○	○	○	—	—	—	—
1.6 N	Without positioning pin	With ground terminal	○	○	○	○	○	○	○	○
		Without ground terminal	○	○	○	○	—	—	—	—
2.6 N	Without positioning pin	With ground terminal	○	○	○	○	○	○	○	○
		Without ground terminal	○	○	○	○	—	—	—	—

Major Specifications

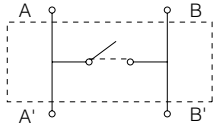
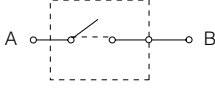
Type		Snap action/Push-on type SPST	
Electrical	Circuit Diagram	<div style="display: flex; justify-content: space-around; align-items: center;"> <div style="text-align: center;"> <p>Top-push</p>  </div> <div style="text-align: center;"> <p>Side-push</p>  </div> </div>	
	Rating	20 mA 15 Vdc	
	Contact Resistance	50 mΩ max.	
	Insulation Resistance	50 mΩ min. (at 100 Vdc)	
	Dielectric Withstanding Voltage	250 Vac for 1 minute	
	Bouncing	3 ms max. (ON) 8 ms max. (OFF)	
Mechanical	Operating Force	1.0 N±0.4 N 1.3 N±0.4 N 1.6 N±0.5 N	2.6 N±0.6 N
	Travel	0.25 mm±0.10 mm	
Endurance	Operating Life	100000 cycles min.*	50000 cycles min.
	Operating Temperature	-20 °C to +70 °C (45 % to 85 % RH)	
	Storage Temperature	-40 °C to +85 °C (Bulk) -20 °C to +40 °C (Taping)	
Minimum Quantity/ Packing Unit	Top-push	Balk	500 pcs. (Vinyl Bag)
		Taping	1000 pcs. (Radial Taping)
	Side-operation	Balk	500 pcs. (Vinyl Bag)
		Taping	700 pcs. (Radial Taping)
Quantity/Carton	Top-push	Balk	10000 pcs.
		Taping	10000 pcs.
	Side-operation	Balk	10000 pcs.
		Taping	7000 pcs.

*1 million cycles also available, consult our salesmen.

■ Dimensions in mm (not to scale)

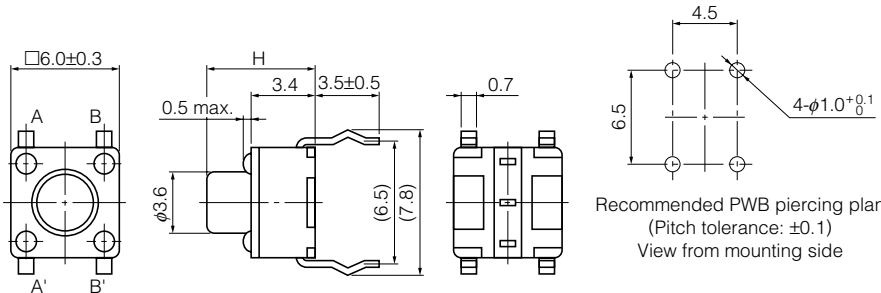
<p>No. 1</p> <p>Japan Malaysia China</p> <p>EVQPA</p> <p>(Bulk)</p> <p>Top-push Without ground terminal</p> 	 <p>Recommended PWB piercing plan (Pitch tolerance: ±0.1) View from mounting side</p>			
Part Numbers	Operating Force	H=Height	Push Plate Color	Operating Life
EVQPAC04M	1.0 N	4.3 mm	White	100000 cycles
EVQPAC05R	1.0 N	5.0 mm	Red	100000 cycles
EVQPAC07K	1.0 N	7.0 mm	Black	100000 cycles
EVQPAC09K	1.0 N	9.5 mm	Black	100000 cycles
EVQPAD04M	1.3 N	4.3 mm	White	100000 cycles
EVQPAD05R	1.3 N	5.0 mm	Red	100000 cycles
EVQPAD07K	1.3 N	7.0 mm	Black	100000 cycles
EVQPAD09K	1.3 N	9.5 mm	Black	100000 cycles
EVQPAE04M	1.6 N	4.3 mm	White	100000 cycles
EVQPAE05R	1.6 N	5.0 mm	Red	100000 cycles
EVQPAE07K	1.6 N	7.0 mm	Black	100000 cycles
EVQPAE09K	1.6 N	9.5 mm	Black	100000 cycles
EVQPAG04M	2.6 N	4.3 mm	White	50000 cycles
EVQPAG05R	2.6 N	5.0 mm	Red	50000 cycles
EVQPAG07K	2.6 N	7.0 mm	Black	50000 cycles
EVQPAG09K	2.6 N	9.5 mm	Black	50000 cycles

■ Dimensions in mm (not to scale)

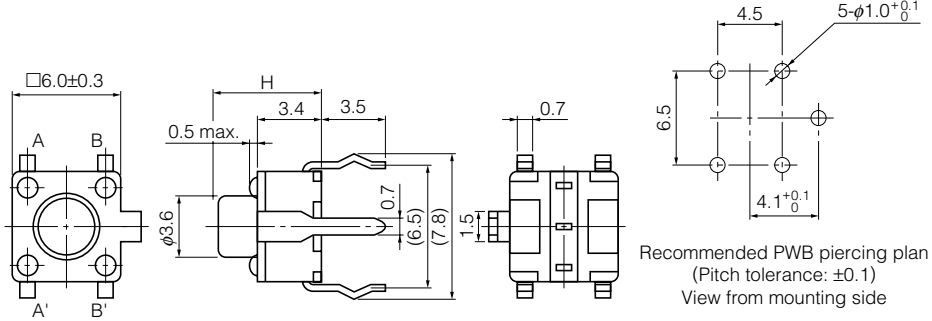
<p>No. 2</p> <p>Japan China</p> <p>EVQPB</p> <p>(Bulk)</p> <p>Top-push With ground terminal</p> 	 <p>Recommended PWB piercing plan (Pitch tolerance: ±0.1) View from mounting side</p>			
Part Numbers	Operating Force	H=Height	Push Plate Color	Operating Life
EVQPBC04M	1.0 N	4.3 mm	White	100000 cycles
EVQPBC05R	1.0 N	5.0 mm	Red	100000 cycles
EVQPBC07K	1.0 N	7.0 mm	Black	100000 cycles
EVQPBC09K	1.0 N	9.5 mm	Black	100000 cycles
EVQPBD04M	1.3 N	4.3 mm	White	100000 cycles
EVQPBD05R	1.3 N	5.0 mm	Red	100000 cycles
EVQPBD07K	1.3 N	7.0 mm	Black	100000 cycles
EVQPBD09K	1.3 N	9.5 mm	Black	100000 cycles
EVQPBE04M	1.6 N	4.3 mm	White	100000 cycles
EVQPBE05R	1.6 N	5.0 mm	Red	100000 cycles
EVQPBE07K	1.6 N	7.0 mm	Black	100000 cycles
EVQPBE09K	1.6 N	9.5 mm	Black	100000 cycles
EVQPBG04M	2.6 N	4.3 mm	White	50000 cycles
EVQPBG05R	2.6 N	5.0 mm	Red	50000 cycles
EVQPBG07K	2.6 N	7.0 mm	Black	50000 cycles
EVQPBG09K	2.6 N	9.5 mm	Black	50000 cycles

■ Dimensions in mm (not to scale)

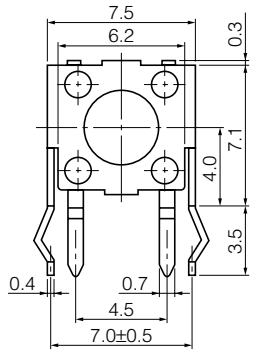
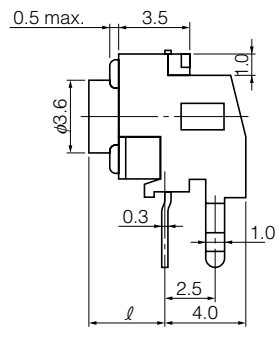
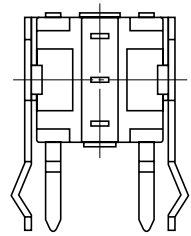
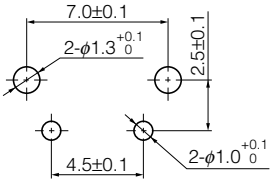
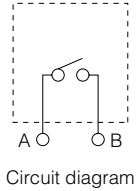
<p>No. 3</p> <p>Japan</p> <p>EVQPF</p> <p>(Bulk)</p> <p>Side-operation Without ground terminal</p> 	    <p>Recommended PWB piercing plan (PWB thickness=1.6 mm) View from mounting side</p>  <p>Circuit diagram</p>			
Part Numbers	Operating Force	ℓ = Push Plate Place	Push Plate Color	Operating Life
EVQPF003M	1.0 N	3.15 mm	White	100000 cycles
EVQPF004R	1.0 N	3.85 mm	Red	100000 cycles
EVQPF006K	1.0 N	5.85 mm	Black	100000 cycles
EVQPF008K	1.0 N	8.35 mm	Black	100000 cycles
EVQPF103M	1.3 N	3.15 mm	White	100000 cycles
EVQPF104R	1.3 N	3.85 mm	Red	100000 cycles
EVQPF106K	1.3 N	5.85 mm	Black	100000 cycles
EVQPF108K	1.3 N	8.35 mm	Black	100000 cycles
EVQPF203M	1.6 N	3.15 mm	White	100000 cycles
EVQPF204R	1.6 N	3.85 mm	Red	100000 cycles
EVQPF206K	1.6 N	5.85 mm	Black	100000 cycles
EVQPF208K	1.6 N	8.35 mm	Black	100000 cycles
EVQPF303M	2.6 N	3.15 mm	White	50000 cycles
EVQPF304R	2.6 N	3.85 mm	Red	50000 cycles
EVQPF306K	2.6 N	5.85 mm	Black	50000 cycles
EVQPF308K	2.6 N	8.35 mm	Black	50000 cycles

■ Dimensions in mm (not to scale)

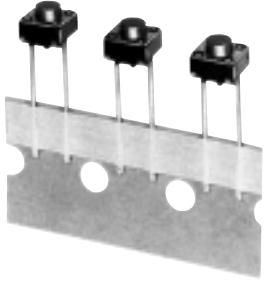
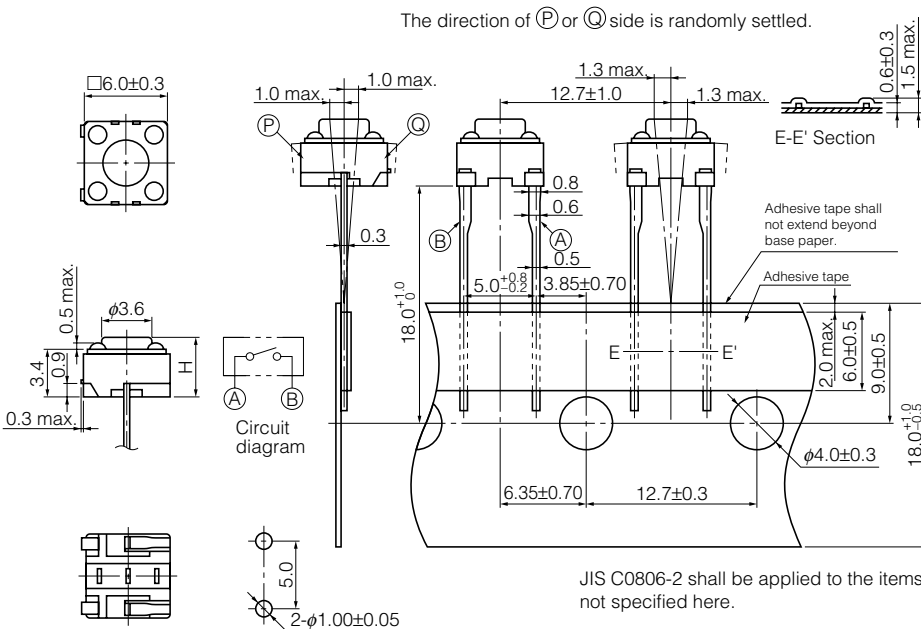
<p>No. 4</p> <p>Japan Malaysia China</p> <p>EVQ2</p> <p>(Radial Taping)</p> <p>Top-push With ground terminal</p> <p>2-terminal type Without ground terminal</p> 	<p>The direction of (P) or (Q) side is randomly settled.</p>  <p>Recommended PWB piercing plan (Pitch tolerance: ±0.1) View from mounting side</p>			
Part Numbers	Operating Force	H=Height	Push Plate Color	Operating Life
EVQ21304M	1.0 N	4.3 mm	White	100000 cycles
EVQ21305R	1.0 N	5.0 mm	Red	100000 cycles
EVQ21307K	1.0 N	7.0 mm	Black	100000 cycles
EVQ21309K	1.0 N	9.5 mm	Black	100000 cycles
EVQ21404M	1.3 N	4.3 mm	White	100000 cycles
EVQ21405R	1.3 N	5.0 mm	Red	100000 cycles
EVQ21407K	1.3 N	7.0 mm	Black	100000 cycles
EVQ21409K	1.3 N	9.5 mm	Black	100000 cycles
EVQ21504M	1.6 N	4.3 mm	White	100000 cycles
EVQ21505R	1.6 N	5.0 mm	Red	100000 cycles
EVQ21507K	1.6 N	7.0 mm	Black	100000 cycles
EVQ21509K	1.6 N	9.5 mm	Black	100000 cycles
EVQ22704M	2.6 N	4.3 mm	White	50000 cycles
EVQ22705R	2.6 N	5.0 mm	Red	50000 cycles
EVQ22707K	2.6 N	7.0 mm	Black	50000 cycles
EVQ22709K	2.6 N	9.5 mm	Black	50000 cycles

Design and specifications are each subject to change without notice. Ask factory for the current technical specifications before purchase and/or use.
Should a safety concern arise regarding this product, please be sure to contact us immediately.

■ Dimensions in mm (not to scale)

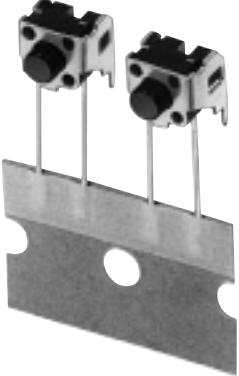
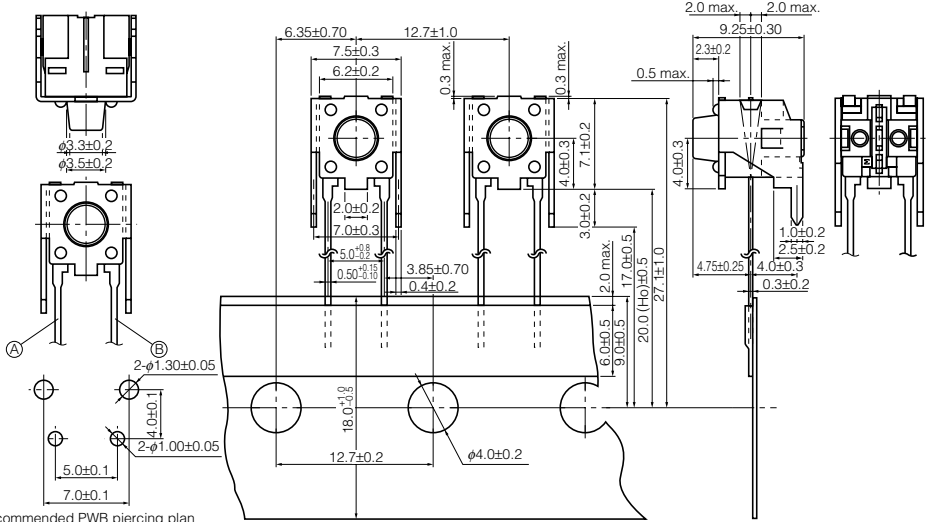
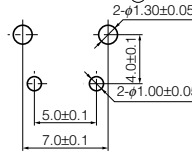
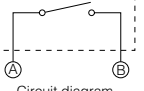
<p>No. 5</p> <p>Japan China</p> <p>EVQPC</p> <p>(Radial Taping)</p> <p>Side-operation Without ground terminal</p> 	 <p>Recommended PWB piercing plan (Pitch tolerance: ±0.1) View from mounting side</p>  <p>Circuit diagram</p> 					
Part Numbers	Operating Force	Push Plate Place	Push Plate Color	Operating Life	Insert Machine	H ₀ Dimension
EVQPC005K	1.0 N	4.75 mm	Black	100000 cycles	Panaset	20 mm
EVQPC105K	1.3 N	4.75 mm	Black	100000 cycles	Panaset	20 mm
EVQPC205K	1.6 N	4.75 mm	Black	100000 cycles	Panaset	20 mm
EVQPC305K	2.6 N	4.75 mm	Black	50000 cycles	Panaset	20 mm
EVQPC405K	1.0 N	4.75 mm	Black	100000 cycles	Avisert	21 mm
EVQPCP05K	1.3 N	4.75 mm	Black	100000 cycles	Avisert	21 mm
EVQPC605K	1.6 N	4.75 mm	Black	100000 cycles	Avisert	21 mm
EVQPC705K	2.6 N	4.75 mm	Black	50000 cycles	Avisert	21 mm

Design and specifications are each subject to change without notice. Ask factory for the current technical specifications before purchase and/or use. Should a safety concern arise regarding this product, please be sure to contact us immediately.