

# IR Receiver Module

## RPM7236-Hx series

RPM7236-Hx series are remote control receiver module. Small-sized, light-weight, and low voltage operated (from 2.7V) modules have been achieved by using resin mold.

### ●Applications

All household electric appliances such as TV, DVD, air conditioner and audio equipment

### ●Features

- 1) Low voltage operation. ( $V_{CC}=2.7$  to  $3.6V$ )
- 2) Low current consumption. ( $I_{CC}=0.3mA$ ,  $V_{CC}=3V$ )
- 3) Superior anti  $V_{CC}$  noise characteristics.
- 4) 5 types of holders available to each set.

### ●RPM7236-Hx series

Sub carrier frequency	TOP VIEW			SIDE VIEW	
	RSIP-A3 (H4)	RSIP-A3 (H8)	RSIP-A3 (H9)	RSIP-A3 (H5)	RSIP-A3 (H13)
Hight of lens	15.9mm	7.2mm	12.0mm	9.6mm	15.0mm
36.0kHz	RPM7236-H4	RPM7236-H8	RPM7236-H9	RPM7236-H5	RPM7236-H13

### ●Absolute maximum ratings ( $T_a=25^{\circ}C$ )

Parameter	Symbol	Limits	Unit
Supply voltage	$V_{CC}$	6.3	V
Output current	$I_o$	2.0	mA
Storage temperature	$T_{stg}$	-30 to +100	$^{\circ}C$

### ●Recommended operating conditions ( $T_a=25^{\circ}C$ )

Parameter	Symbol	Min.	Typ.	Max.	Unit
Supply voltage	$V_{CC}$	2.7	3.0	3.6	V
Operating temperature	$T_{opr}$	-10	25	75	$^{\circ}C$

Photo Link Module

●Block diagram

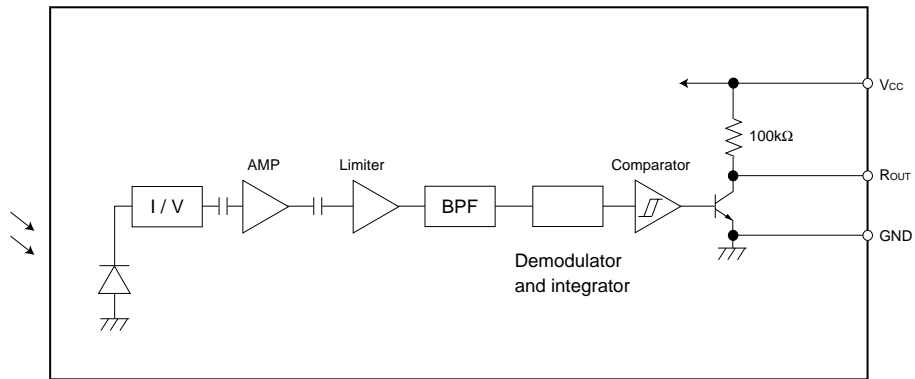

●Terminal description

Pin No.	Pin name	Function
1	V <sub>OUT</sub>	OUTPUT TERMINAL
2	GND	GROUND
3	V <sub>CC</sub>	POWER SUPPLY



●Electrical, Optical characteristics (Unless otherwise noted Ta=25°C, V<sub>CC</sub>=3V)

Parameter	Symbol	Min.	Typ.	Max.	Unit	Conditions
Consumption current	I <sub>CC</sub>	–	300	500	μA	No outside light, no signal input.
Effective distance	L	10	15	–	m	*1 Outer light condition E <sub>e</sub> < 10 (lx)
High level output voltage	V <sub>H</sub>	2.5	–	–	V	*1
Low level output voltage	V <sub>L</sub>	–	–	0.5	V	*1 I <sub>sink</sub> < 200μA
ON pulse width	T <sub>ON</sub>	400	600	800	μs	*1 Outer light condition E <sub>e</sub> < 10 (lx)
OFF pulse width	T <sub>OFF</sub>	400	600	800	μs	*1 Outer light condition E <sub>e</sub> < 10 (lx)
Central frequency	f <sub>o</sub>	–	36.0	–	kHz	
Horizontal half angle	θ 1/2	–	45	–	deg	*2
Vertical half angle	θ 1/2	–	35	–	deg	*2

\*1 The burst wave form mentioned in Fig.1 is to be transmitted from standard transmitter(Fig.2)  
Measure 10th or later pulse width after beginning of transmission.

\*2 The angle which effective distance become 50% of L. (effective distance at θ=0°)

● Measurement Conditions

(1) Transmit signal

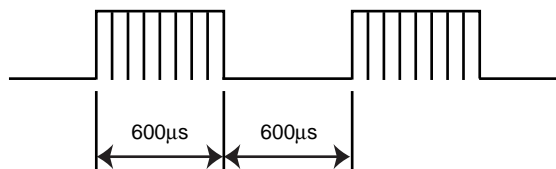

Carrier frequency=f<sub>o</sub>, Duty=50%

Fig.1 Transmit signal.

Photo Link Module

(2) Standard transmitter

$\lambda_{\text{peak}}=940\text{nm}$   
 $\Delta \lambda =40\text{nm}$

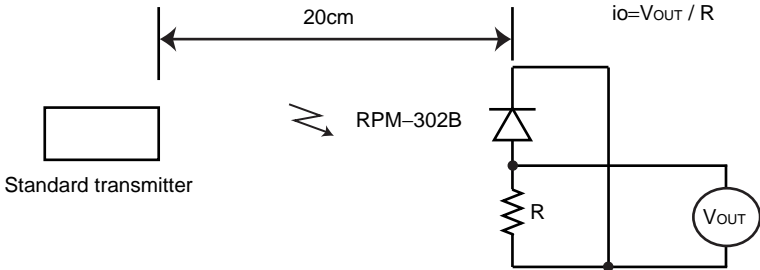

Fig.2 Measurement of standard transmitter proof reading.

When standard transmitter output the signal at Fig.1 standard photodiode output become  $i_o=5\mu\text{Ap-p}$  under the measurement condition Fig.2.

(The radiant intensity of standard transmitter :  $50\text{mW / sr}$ )

RPM-302B: standard photodiode has short current  $I_{sc}=27\mu\text{A}$  at  $E_e=1000(\text{lx})$   
 (using CIE standard light source A)

(3) Measurement effective distance, horizontal & vertical half angle

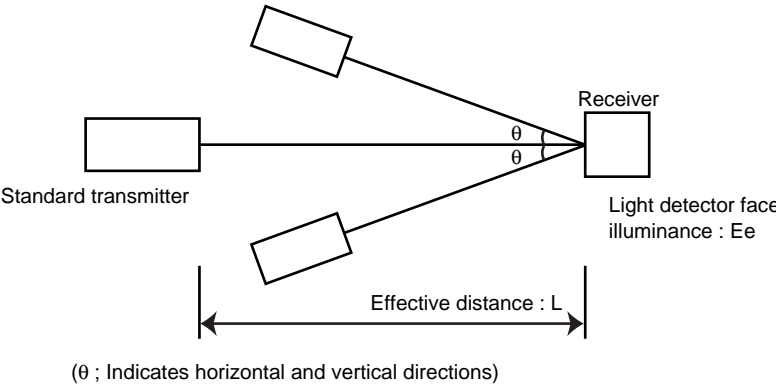

( $\theta$  ; Indicates horizontal and vertical directions)

Fig.3 Measurement condition for effective distance.

Effective distance L : Effective distance at  $\theta=0^\circ$  Fig.3  
 Horizontal & vertical half angle  $\theta$  : The angle which effective distance became 50% of L.

## Photo Link Module

## (4) Output signal

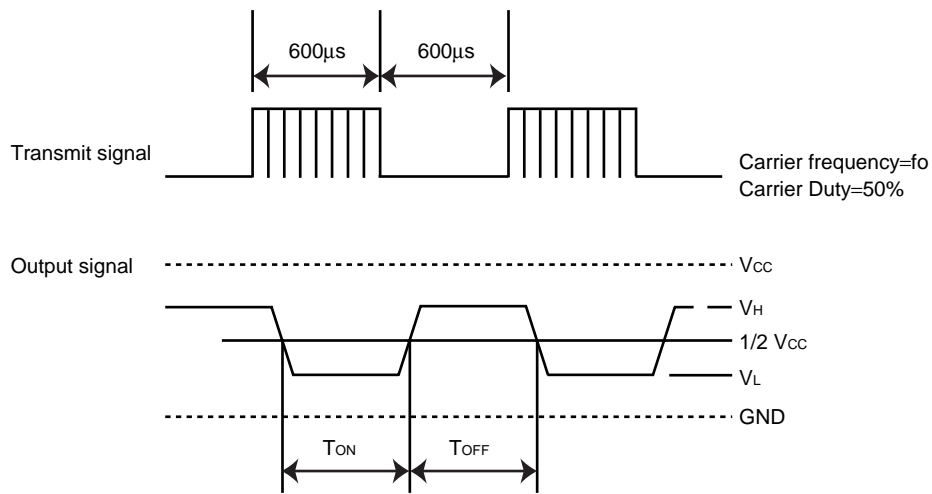

Fig.4

## (5) Measurement circuit for the output voltage and the consumption current

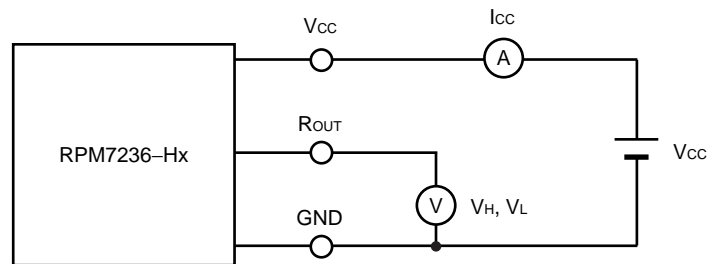

Fig.5

## ●Notes

- (1) All characteristics of the receiver in this specification are specified by supplying burst wave form with ROHM standard transmitter (Shown as 8 (2) ).  
If in case of other burst wave form will be used, please check these spec. carefully under the evaluations.
- (2) When the receiver will be used as the wire-less remote controller, please use the signal format RC5 Code, RC6 Code, RCMM Code.  
If using other signal method, signal format, the receiver might have chances to miss-function.
- (3) Please set up transmitter's carrier frequency as same as the receiver's  $f_0$  frequency. Otherwise error might be occurred.

## Photo Link Module

(4) If transmission signal has non-continuous carrier, error might be occurred. Continuous carrier is necessary.

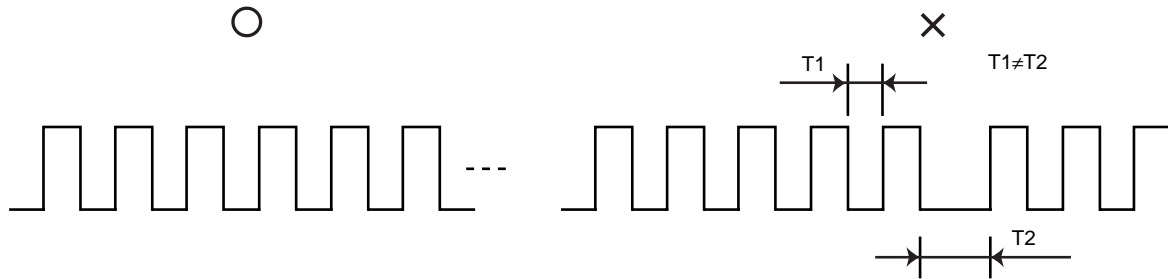

(5) The receiver was designed to use as in-door use only.

Therefore, please understand that the receiver cannot cover all characteristics, in case of using it out-door.

(6) Noise environment (Light noise from inverter Lamp, and other kind of Lamps, Power ripple, electromagnetic noise from power circuit, and etc) may cause a reduced effective distance.

(7) The receiver may not work properly if the receiving signal judgment is done by single pulse due to the surrounding / environmental noises.

To prevent such misjudgment, please make sure that the receiver is set up to work only when receiving series of the coded signal.

(8) Emitting unit (remote control transmitter) has to be considered about its emitting device function, characteristics and characteristics of the receiver.

(9) Attach holder on PCB pattern.

(Holder do not conduct to GND)

(10) Do not supply unnecessary stress to lead and holder.

(11) Please pay attention to the lens carefully.

It might have a chance to miss-function when the lens get dust or dirty.

Also, please do not touch the lens.

(12) In order to protect the products from ESD, human body, solder iron and etc. are required to be grounded.

Photo Link Module

●External dimensions (Unit : mm)

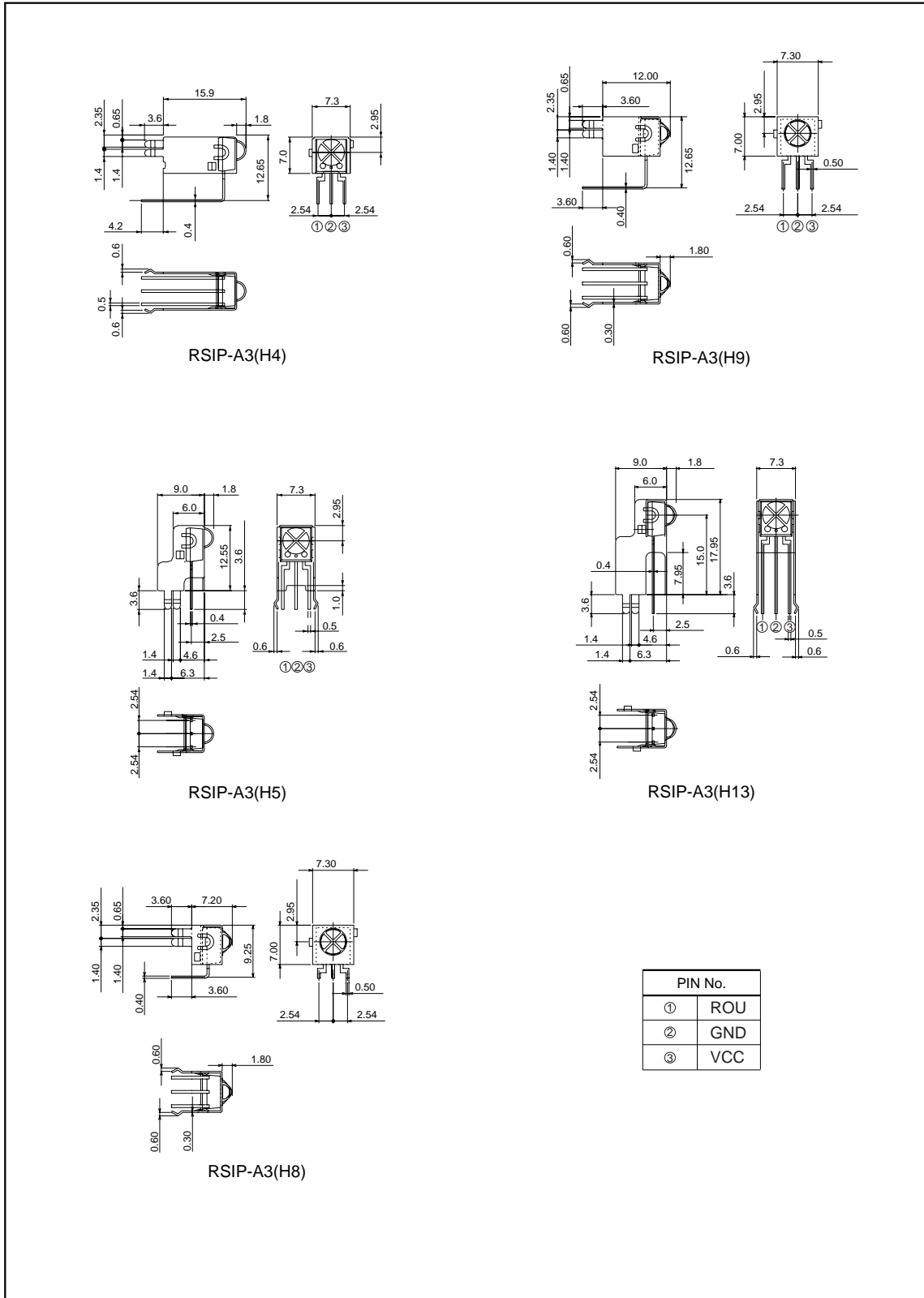

### Notes

- No technical content pages of this document may be reproduced in any form or transmitted by any means without prior permission of ROHM CO.,LTD.
- The contents described herein are subject to change without notice. The specifications for the product described in this document are for reference only. Upon actual use, therefore, please request that specifications to be separately delivered.
- Application circuit diagrams and circuit constants contained herein are shown as examples of standard use and operation. Please pay careful attention to the peripheral conditions when designing circuits and deciding upon circuit constants in the set.
- Any data, including, but not limited to application circuit diagrams information, described herein are intended only as illustrations of such devices and not as the specifications for such devices. ROHM CO.,LTD. disclaims any warranty that any use of such devices shall be free from infringement of any third party's intellectual property rights or other proprietary rights, and further, assumes no liability of whatsoever nature in the event of any such infringement, or arising from or connected with or related to the use of such devices.
- Upon the sale of any such devices, other than for buyer's right to use such devices itself, resell or otherwise dispose of the same, no express or implied right or license to practice or commercially exploit any intellectual property rights or other proprietary rights owned or controlled by
- ROHM CO., LTD. is granted to any such buyer.
- Products listed in this document are no antiradiation design.

The products listed in this document are designed to be used with ordinary electronic equipment or devices (such as audio visual equipment, office-automation equipment, communications devices, electrical appliances and electronic toys).

Should you intend to use these products with equipment or devices which require an extremely high level of reliability and the malfunction of which would directly endanger human life (such as medical instruments, transportation equipment, aerospace machinery, nuclear-reactor controllers, fuel controllers and other safety devices), please be sure to consult with our sales representative in advance.

#### About Export Control Order in Japan

Products described herein are the objects of controlled goods in Annex 1 (Item 16) of Export Trade Control Order in Japan.

In case of export from Japan, please confirm if it applies to "objective" criteria or an "informed" (by MITI clause) on the basis of "catch all controls for Non-Proliferation of Weapons of Mass Destruction.